

november, 1939

25 cents

# QST



devoted entirely to

# amateur radio



# COLLINS 127E

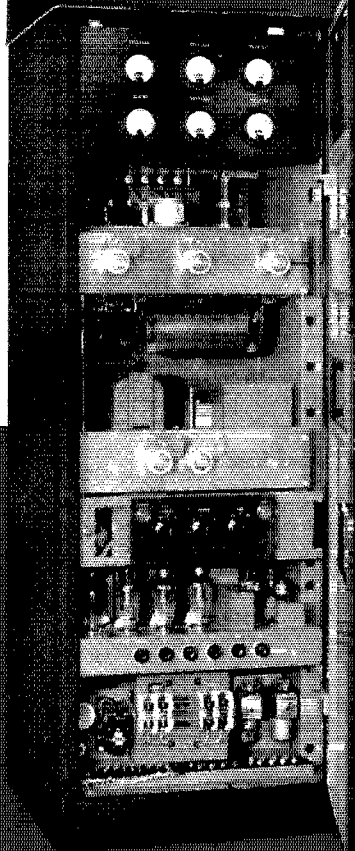
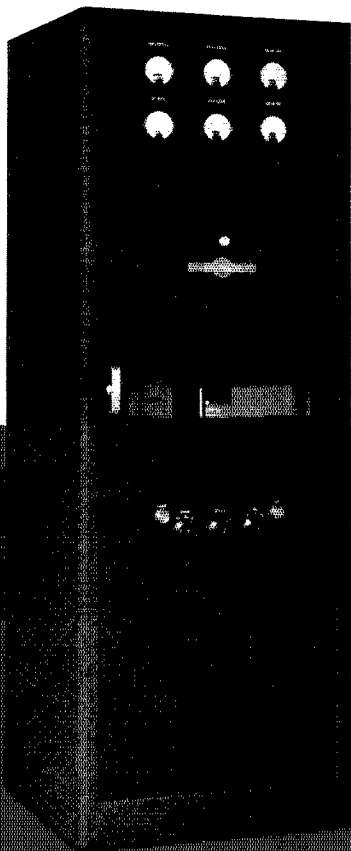

The 127E Transmitter is designed with features which make it universally applicable as a multifrequency transmitter for marine shipboard, marine shore, aeronautical ground and police services. A combination of high frequency and intermediate frequency operation, with the latter optional, covers most commercial requirements.

The 127E is completely housed in a compact sturdy cabinet of processed metal construction for protection against salt water atmosphere. Components are assembled on removable cast aluminum frames and decks. Electrical circuits are made by heavy duty automatic connectors and wiring is not disturbed when sections are removed through the front of the transmitter for inspection and service.

Collins Autotune System is operated by a ten position selector switch which com-

pletely retunes the transmitter, in six seconds or less, to any one of ten crystal controlled frequencies.

**RATED POWER OUTPUT:** 500 watts  $A_1$  emission and 300 watts  $A_2$  and  $A_3$  emission.

**FREQUENCY RANGE:** High frequency 2000 to 16,000 kc. Intermediate frequency 300 to 500 kc (optional).

**MODULATION CAPABILITY:** 100%.

**AUDIO FREQUENCY RESPONSE:** Uniform within plus or minus 2 db from 200 to 3000 cycles.

**AUDIO FREQUENCY HARMONIC DISTORTION:** Less than 10% R.M.S. total harmonics at any modulation level at 400 cycles.

**CARRIER NOISE LEVEL:** More than 40 db below 100% modulation on  $A_3$ .

**KEYING SYSTEM:** Allows full break-in operation. Antenna keyed on i.f. only. Antenna change-over relay provided for h-f operation. Keying speed of 40 w.p.m.

**CABINET DIMENSIONS:** 72" high, 21" wide, 22" deep. Shock mounting supplied when required.

**POWER SOURCE:** 115 volts, 60 cycle single phase a.c. A converter is supplied for operation from 110 volt d.c. when required.

## COLLINS RADIO COMPANY

CEDAR RAPIDS, IOWA — NEW YORK, N. Y.: 11 WEST 42 STREET

2505

hallicrafters, Inc.  
CHICAGO

P. 23  
 Draft Characteristics of SKYRIDER 23  
 Date 12-11-43  
 C. = 313  
 Variable gain  
 C. = ballasted Coudeux-0.244  
 Temp. room temperature for 2 hours  
 be presented in separate set 2 hours  
 C. change  
 T. rise  
 C. change  
 28°C  
 40°C  
 +0.244td  
 -0.344td  
 12°C  
 313.5 x 568 = 881.5  
 1780680  
 17680  
 17670  
 17420  
 -0.544td  
 2.08 + 44td  
 000206 747/947/10

Back of the

# SKYRIDER 23

A communications receiver — no matter how well constructed — is no better than its engineering. Each function in the SKYRIDER 23 was carefully analyzed from the most scientific approach before it was incorporated into the final circuit. (This page on drift characteristics from the Laboratory Data Book is an interesting example.) That is a vital reason why the "23" is one of the best receivers the Hallicrafters has built. Yet it is available at your Distributors, for only a \$23.10 down payment, less speaker. See it today. Try it tonight.

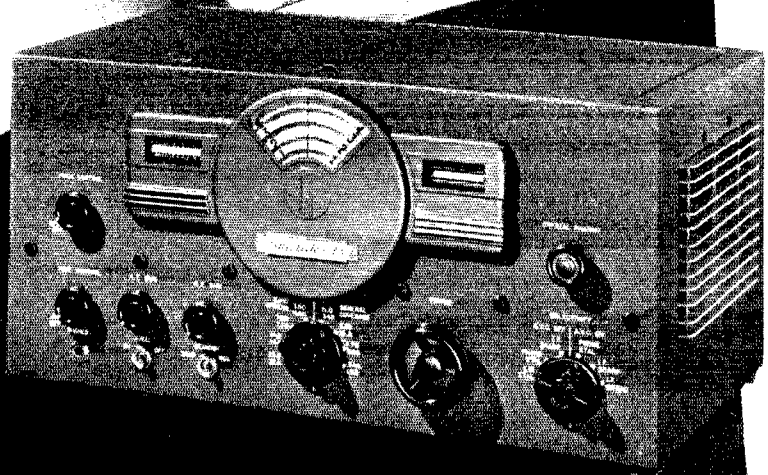

## the hallicrafters inc.

CHICAGO, U. S. A.

"LARGEST BUILDERS OF AMATEUR COMMUNICATIONS EQUIPMENT"

# hallicrafters Equipment for every Communications Purpose

SKY BUDDY is an 18-feature communications receiver with continuous coverage from 44 MC to 545 KC with uniform sensitivity over the entire range. Electrical band spread. Beat frequency oscillator. Built-in line filter. Built-in rubber mounted speaker, etc. **\$29<sup>50</sup>**



Skyrider DEFIANT offers performance usually associated with more expensive receivers. Four bands cover from 43.5 MC to 545 KC. Frequency Meter tuning on 10, 20, 40, and 80 meter amateur bands. Controls include RF gain, Selectivity switch, Crystal phasing, Audio gain, Pitch control, Bandspread tuning, A.N.L. switch, BFO, etc., with crystal, **\$69<sup>50</sup>** less speaker



Super SKYRIDER SX-17 (illustrated at the left) is the finest communications receiver the Hallicrafters make. Has two stages of preselection, built-in Dickert noise limiter. Iron-core air tuned I.F. circuits provide wide range variable selectivity—from broad high-fidelity to single signal sharpness. 1000° Spiral bandspread dial. Plus numerous other quality features. With crystal, less speaker. **\$137<sup>50</sup>**

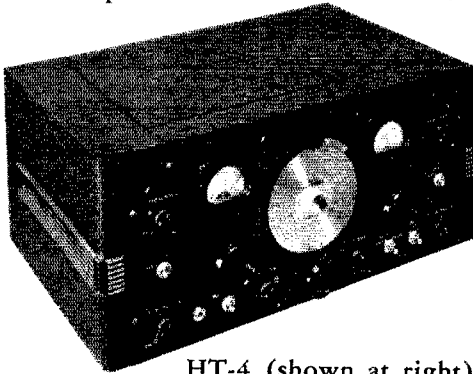

HT-4 (shown at right) is a high-powered amateur transmitter, giving 450 watts on CW and 325 watts on phone. Separate preamplifier allows remote control of volume, keying and standby. Transmitter may be set to any three of the 10, 20, 40, 80 or 160 meter bands. Like all Hallicrafters equipment, immediately available. Includes Preamplifier, coils and crystals **\$69<sup>50</sup>** for three bands.

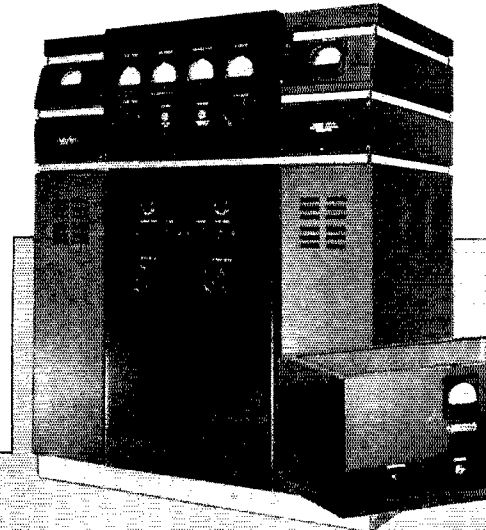

the hallicrafters inc.  
CHICAGO, U. S. A.

"LARGEST BUILDERS OF AMATUER COMMUNICATIONS EQUIPMENT"

NOVEMBER 1939

VOLUME XXIII

NUMBER 11



STAFF

Editorial

KENNETH B. WARNER, W1EH  
Editor and Business Manager

CLARK C. RODIMON, W1SE  
Managing Editor

GEORGE GRAMMER, W1DF  
Technical Editor

DONALD H. MIX, W1TS  
BYRON GOODMAN, W1PJE  
Assistant Technical Editors

VERNON CHAMBERS, W1JEQ  
Technical Information Service

JAMES J. LAMB, W1AL  
Consultant

Advertising

F. CHEYNEY BEEKLEY, W1GS  
Advertising Manager

CHARLES BRUNELLE  
Asst. Advertising Manager

Circulation

DAVID H. HOUGHTON  
Circulation Manager

RALPH T. BEAUDIN, W1BAW  
Asst. Circulation Manager



OFFICES

38 La Salle Road  
West Hartford, Connecticut

Subscription rate in United States and Possessions and Canada, \$2.50 per year, postpaid; all other countries, \$3.00 per year, postpaid. Single copies, 25 cents. Foreign remittances should be by international postal or express money order or bank draft negotiable in the U. S. and for an equivalent amount in U. S. funds.

Entered as second-class matter May 29, 1919, at the post office at Hartford, Connecticut, under the Act of March 3, 1879. Acceptance for mailing at special rate of postage provided for in section 1103, Act of October 3, 1917, authorized September 9, 1922. Additional entry at Concord, N. H., authorized February 21, 1929, under the Act of February 28, 1925. Additional second-class entries to cover sectional editions authorized March 20, 1935.

Copyright 1939 by the American Radio Relay League, Inc. Title registered at United States Patent Office.

# QST

devoted entirely to

# AMATEUR RADIO

PUBLISHED, MONTHLY, AS ITS OFFICIAL ORGAN, BY THE AMERICAN RADIO RELAY LEAGUE, INC., AT WEST HARTFORD, CONN., U. S. A.:  
OFFICIAL ORGAN OF THE INTERNATIONAL AMATEUR RADIO UNION



## CONTENTS

Editorials	9
Splatter	10
More Thoughts on Effective Antennas	
<i>Arthur H. Lynch, W2DKJ</i>	11
Stacking Coaxial Antennas	17
<i>Edwin R. Sanders</i>	
Silent Keys	19
A Simple Freqmeter-Monitor	20
<i>H. S. Britt, W7CQE</i>	
What the League Is Doing	22
Cathode Modulation	
<i>Frank C. Jones, W6AJF and Frank W. Edmonds, W2DIY</i>	23
Results of U.H.F. Relay	26
<i>F. E. Handy, W1BDI</i>	
Coil Chart for Quick Reference	28
<i>L. C. Gallagher, W5FRE</i>	
New Transmitting Tube	29
Naval Communication Reserve Notes	30
Don't Miss the Tenth A.R.R.L. Sweepstakes	
<i>F. E. Handy, W1BDI</i>	31
Pointers on Design and Adjustment of High-Efficiency	
Grid-Modulated Amplifiers	34
<i>Charley W. Binkler, W9AKC</i>	
A Single-Control Wide-Range Tank Circuit	
<i>T. M. Ferrill, Jr., W1LJI</i>	38
Scores, VE/W Contact Contest, 1939	40
<i>Romeo Leonard, VE2HZ</i>	
A Safety Kilowatt Transmitter	42
<i>W. T. Bishop, W9UI</i>	
Link Coupling for the Rotary Antenna	
<i>J. M. Burke, Jr., W5EMF</i>	46
New Method of Rating Transmitting Tubes	48
Clyde Gardner, W6KOT	48
A New Method of Measuring A.C. Voltages	
<i>George S. Wachtman</i>	49
Another U.H.F. Relay	53
The Portable at W7AW	54
<i>I. Lee Iversen, W7AW</i>	
Model Three-Element Beam Demonstrated at Convention	59
I.A.R.U. News	60
Hints and Kinks	
Direction Finding With B.C. Portables — Rotatable Antenna	
Support from Automobile Parts — Measuring Radio Frequency Power Output	62
Correspondence Department	65
Operating News	66
Hamfesters Picnic	114
A.R.R.L. QSL Bureau	116
Hamads	123
QST's Index to Advertisers	126

# Taylor Tubes

# SALUTES HELWIG-SPEER

In acknowledging the tremendous popularity of Taylor's two Wonder Tubes, the T-40 and TZ-40, it is natural that Taylor Tubes salute the Helwig-Speer Carbon Company, whose fine Carbon Anodes have proved their stamina in the T-40 and TZ-40, by devoting this space to tell you —

## WHY CARBON IS BETTER!

The ability of carbon to stand up and deliver maximum results under all working conditions — its better physical characteristics, make it truly a splendid anode material. Remember that the amount of power a tube will handle as an Oscillator — Amplifier — Doubler-Modulator or Rectifier — depends to a large degree on the ability of the anode to dissipate heat. Because carbon has an extremely *high radiation emissivity*, and *high thermal conductivity*, anodes made of carbon are superior. We list here some of the major reasons why carbon is a preferred anode material.

## RADIATION EMISSIVITY

It is an established scientific fact that rough, black surfaces radiate heat many times faster than smooth metallic surfaces. This feature of carbon insures lower temperatures of all associated tube parts — adding to the tube's ability to withstand overloads.

## THERMAL CONDUCTIVITY

The high thermal conductivity of Helwig-Speer Carbon Anodes, produces quicker diffusion and a more uniform distribution of heat throughout the anodes. This feature prevents hot spots which result in warping and fusing of the anode material. Tubes using Carbon Anodes, can be made with smaller elements because carbon radiates heat at a faster rate. This means low inter-electrode capacities and permits successful operation at higher frequencies.

## DEGASSING QUALITY

All known materials, usable as anodes, have a heat point at which all gasses will be expelled. In degassing a tube, tremendous heat is induced into the anode by Radio Frequencies while a series of vacuum pumps of special design carry away the gases being liberated. (*It is interesting here to note that carbon has the highest melting point of all common anode materials. Carbon does not melt at temperatures under 3537°C while Tungsten has a 3370°C melt point, Tantalum a 2850°C melt point and Molybdenum a 2620°C melt point.*) Regardless of the anode material used this process of degassing is always followed. A TUBE MADE "GAS-FREE" IN PRODUCTION REMAINS "GAS-FREE". Helwig-Speer Processed carbon anodes have ideal degassing qualities and compare, in this respect, more than favorably with all other anode materials.

Taylor HEAVY **CUSTOM BUILT** DUTY Tubes

# EXPERIENCE GAINED IN PRODUCING 20,000 Taylor Tubes

## T-40's and TZ-40's NOW MAKES POSSIBLE

### Increased Ratings

Over 20,000 of these Wonder Tubes have been made and sold in 20 months. Continued research and experiment have proved that in INTERMITTENT AMATEUR SERVICE our original Operating Ratings were extremely conservative. The new ratings shown below are still conservative and allow you true long life performance. The regular operating ratings remain the same for continuous commercial service, the new ratings for Intermittent Amateur Service.

#### T-40 . . . . . TZ-40

<i>Commercial</i>	<i>Class C Telegraph</i>	<i>Amateur</i>
1250 V.	Plate Volts	1500 V.
125 M.A.	Plate Current	150 M.A.
31 M.A.	Grid Current	38 M.A.
	<i>Class C Telephone</i>	
1000 V.	Plate Volts	1250 V.
115 M.A.	Plate Current	125 M.A.
40 M.A.	Grid Current	40 M.A.

### Conservative Ratings

The performance in actual service of the Wonder Tubes T-40 and TZ-40 over the past 20 months prove that Taylor's ratings are conservative. The *husky Carbon Anode* is rated at only 40 watts, yet it actually takes 70 watts plate dissipation to cause the anode to show color. That means your T-40 or TZ-40 can stand serious overloads without damage—a real safety factor. The *complete Molybdenum Grid* designed for heavy duty service withstands abnormal abuses. *Taylor Tube filaments* are designed as to diameter and length so that they provide the necessary surface area needed to furnish emission in amounts well beyond the requirements of maximum peak plate current with good emission efficiency in terms of filament power at safe temperature for long life.

When Taylor Tubes brought out the Wonder Tubes—T-40 and TZ-40—comparative types sold at \$10.00. Amateurs the world over quickly recognized the outstanding value of the T-40 and TZ-40 and rapidly they have become the most popular of all Amateur Transmitting Tubes. Naturally the tremendous success of these Wonder Tubes has attracted competition—and we expect more. We ask you to remember that the experience gained in producing this large number of tubes is your best assurance of Better Performance and Top Value. *Insist on Taylor's T-40's and TZ-40's—conservatively rated like all Taylor Tubes—and proved through use.*

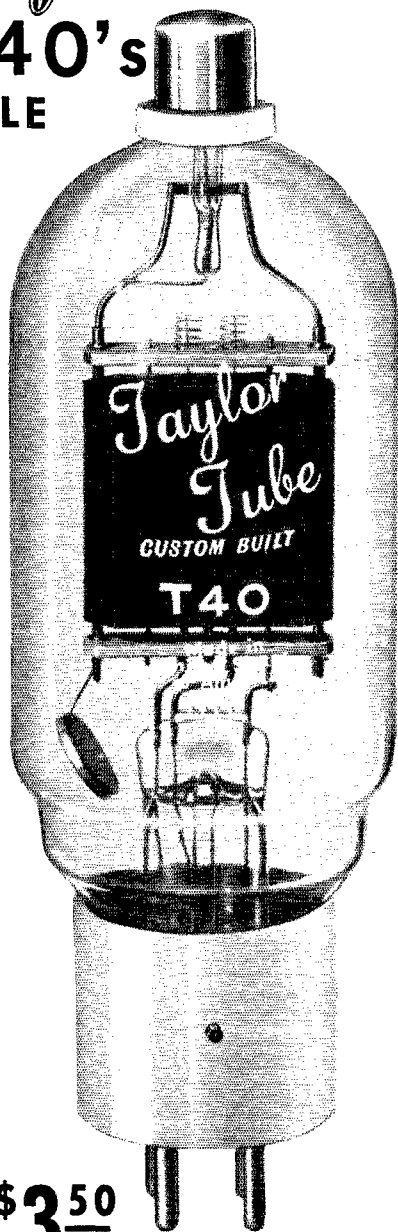

ACTUAL SIZE

RECOMMENDED BY LEADING PARTS DISTRIBUTORS

*"More Watts Per Dollar"*

TAYLOR TUBES, INC., 2341 WABANSIA AVE., CHICAGO, ILLINOIS

## Section Communications Managers of the A.R.R.L. Communications Department

All appointments in the League's field organization are made by the proper S.C.M., elected by members in each Section listed. Mail your S.C.M. (on the 16th of each month) a postal covering your radio activities for the previous 30 days. Tell him your DX plans for experimenting, results in phone and traffic. He is interested, whether you are an A.R.R.L. member or get your QNT at the newsstands; he wants a report from every active ham. If interested and qualified for O.R.S., O.P.S. or other appointments he can stand you about them, too.

<b>ATLANTIC DIVISION</b>				
Eastern Pennsylvania Maryland-Delaware-District of Columbia Southern New Jersey Western New York Western Pennsylvania	W3BES W3BAK W3CCQ W8CSE W8ORF	Jerry Mathis Edgar L. Hudson Lester H. Allen Ed Preston Kendall Speer, Jr.	5132 Havertord Ave. 704 Quinton Ave. 10 Lincoln Ave.	Philadelphia Laurel, Delaware Trenton Tully Lowher
<b>CENTRAL DIVISION</b>				
Illinois Indiana Kentucky Michigan Ohio Wisconsin	W9RMN W9CGT W9ARU W8DPE W8AQ W9UIT	Leslie M. Dickson Noble Burkhardt Darrell A. Howard Harold C. Bird E. H. Gibbs Aldrich C. Krones	Edellyn Farms R. 4, Box 1 116 N. Longworth Ave. R.F.D. 2 405 Broad St. 3127-A West Madison St.	Waukegan Indianapolis Louisville Pontiac Wadsworth Milwaukee
<b>DAKOTA DIVISION</b>				
North Dakota South Dakota Northern Minnesota Southern Minnesota	W9WWL W9VDD W9ICZ W9YNQ	Anton C. Theodos Dr. A. L. Russell Edwin L. Wicklund Millard L. Bender	c/o American Cafe R.F.D. 3 608 N. Huron Ave.	Minot Philip Kensington Spring Valley
<b>DELTA DIVISION</b>				
Arkansas Louisiana Mississippi Tennessee	W5ABI W5DKR W5EWD W4DWS	H. E. Velte Eugene H. Treadaway Jewell W. Cole William Harold Walker	4415 West 12th St. 2749 Myrtle St. c/o City of McComb Water Dept. 2503 Belmont Blvd.	Little Rock New Orleans McComb City Nashville
<b>HUDSON DIVISION</b>				
Eastern New York N. Y. C. & Long Island Northern New Jersey	W2LJ W2JZY W2GVZ	Robert E. Hagitt E. L. Bauquet Joseph P. Jessup	511 South Holmes St. 102 Central Ave. 131 California St.	Scotia Massapequa, L. I. Ridgewood
<b>MIDWEST DIVISION</b>				
Iowa Kansas Missouri Nebraska	W9PIR W9UEG W9UDD W9DI	L. B. Vennard Melvin D. Kirby Miss Letha Allendorf William J. Barner	P. O. Box 304 1015 W. 3rd St.	West Burlington Arlington Joplin Tobias
<b>NEW ENGLAND DIVISION</b>				
Connecticut Maine Eastern Massachusetts Western Massachusetts New Hampshire Rhode Island Vermont	W1CTI W1HIE W1HIL W1JAH W1BET W1HRC W1KJG	Frederick Ellis, Jr. H. W. Cramer Larry Mitchell William J. Barrett Carl B. Evans Clayton C. Gordon Clifton G. Parker	10 Merrill Rd. 147 Church 94 Howard St. 249 Columbia St. 163 South Main St. 192 Washington Ave. Box 537	Norwalk Lamariscotta Melrose Adams Concord Providence Morrisville
<b>NORTHWESTERN DIVISION</b>				
Alaska Idaho Montana Oregon Washington	W7ENA W7EMT W7FL W7DXF W7FCG	Les E. Ochsmann Carl Bichelberger G. A. Woodhouse Harold W. Johnston W. Beale	Customhouse Route 2 Holter Dam 305 North Grant St. R. 4, School Ave.	Wrangell Kuna Wolf Creek Pendleton Walla Walla
<b>PACIFIC DIVISION</b>				
Hawaii Nevada Santa Clara Valley East Bay San Francisco Sacramento Valley Philippines San Joaquin Valley	K6ETF W6BIC W6RHW W6TJ W6CIS W6MDI KAIGR W6KUT	Francis T. Blatt Edward W. Heim Albert Amantakes Horace R. Greer Kenneth E. Hughes Vincent N. Beldhausen George L. Rickard Edwin A. Adress	837 16th Ave. 509 Claremont St. 354 Washington St. 414 Fairmount Ave. 622-36th Ave. 113 South Quincy St. Box 849 2921 North Van Ness Blvd.	Honolulu Reno San Jose Oakland San Francisco McCloud Manila Fresno
<b>ROANOKE DIVISION</b>				
North Carolina South Carolina Virginia West Virginia	W4CVB W4BOE/ANG W3UVA W8HD	W. J. Wortman Ted Ferguson Charles M. Watt, Jr. C. S. Hoffmann, Jr.	P. O. Box 566 1213 College St. Box 1212 47 Lynwood Ave.	Morganton Reno University Wheeling
<b>ROCKY MOUNTAIN DIVISION</b>				
Colorado Utah-Wyoming	W9EHC W7CLG	Carl C. Drumeller Ernest E. Parshall	819 East Dale St. Salt Creek Electric Plant	Colorado Springs Midwest, Wyoming
<b>SOUTHEASTERN DIVISION</b>				
Alabama Eastern Florida Western Florida Georgia West Indies (Cuba-Isle-of-Pines- Porto Rico-Virgin Islands)	W4DGS W4DVO W4AXP W4AGI CM2OP	James F. Thompson L. A. Connolly Oscar Cederstrom Leland W. Smith Mario de la Torre	12 Clanton Ave. Waucoma Apts. 719 So. Willow Ave. Second St. & Bruce Ave. 2010 Pennsylvania Ave. Escobar 110 (Altos)	Montgomery Tampa De Funiak Springs Augusta Habana, Cuba
<b>SOUTHWESTERN DIVISION</b>				
Los Angeles Arizona San Diego	W6MQM W6KMM W6JRM	Ralph S. Click Marson B. Hull Howard K. Breedlove	1038 Milwaukee Ave. 617 North Fourth Ave. R. 2, Box 636	Los Angeles Phoenix San Diego
<b>WEST GULF DIVISION</b>				
Northern Texas Oklahoma Southern Texas New Mexico	W5DXA W5CEZ W5BHO W5EN1	Lee Hughes Carter L. Simpson Dave H. Calk Dr. Hilton W. Gillett	125 N. Main St. 2010 So. 4th St. 6726 Ave. Q	Childress Ponca City Houston Lovington
<b>MARITIME DIVISION</b>				
Maritime	VE1DQ	A. M. Crowell	69 Dublin St.	Halifax, N. S.
<b>ONTARIO DIVISION</b>				
Ontario	VE3SG	F. H. B. Saxon	302 Lee Ave.	Toronto, Ont.
<b>QUEBEC DIVISION</b>				
Quebec	VE2CO	Lindsay G. Morris	Apt. 6, 4510 Gironard Ave., N.D.G.	Montreal, P. Q.
<b>VALALTA DIVISION</b>				
Alberta British Columbia	VE4TE VE5HP	C. S. Hamilton J. Hepburn, Jr.	581 W. Riverside Drive 335 Foul Bay Road	Drumheller, Alta. Victoria
<b>PRAIRIE DIVISION</b>				
Manitoba Saskatchewan	VE4AAW VF4SY	A. W. Morley Arthur Chesworth	747 McMillan Ave. 1071 4th Ave., N. W.	Winnipeg Moose Jaw



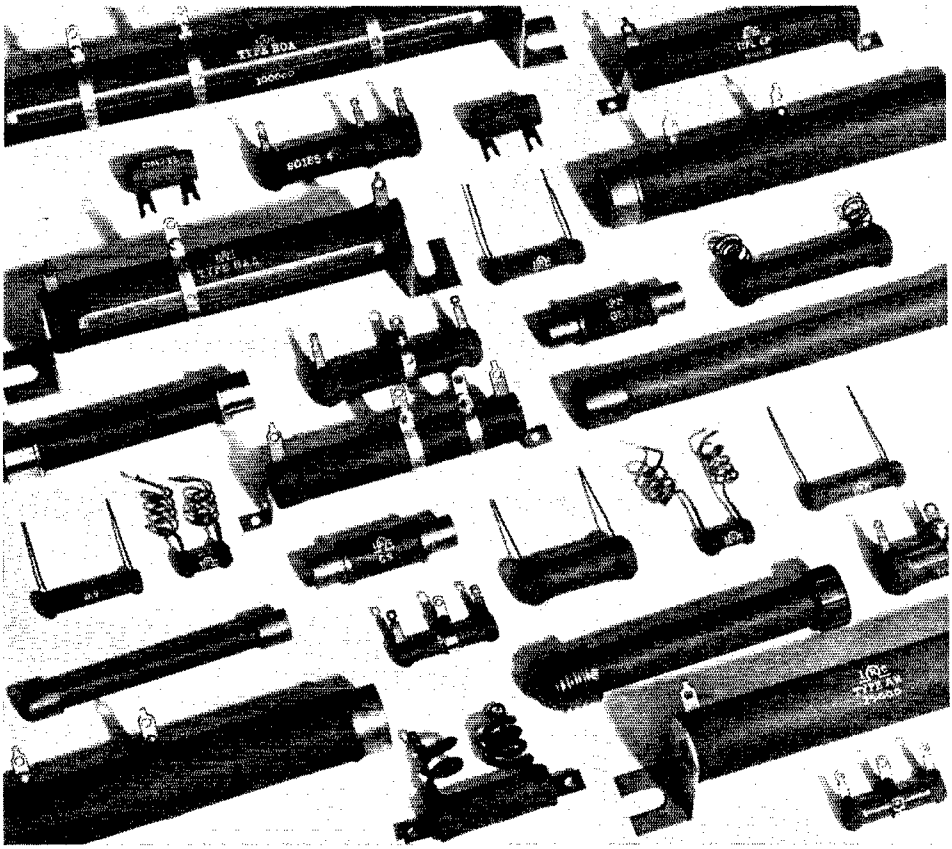

## B and B

We make more different types of resistance units than any other company in the world — each having characteristics making it particularly suitable for a certain class of service.

There is naturally a temptation to devote this page to some new development in resistors or circuit application, but we should not neglect one of our old standbys — in fact, our Bread and Butter in the average ham shack — the cement-coated power wire wound resistors.

Their acceptance is no accident. In food mixers and Pullman cars, desk fans and submarines, furnace controls and dental equipment, in Peace and in War, they carry on their unspectacular task. They make no headlines but many headlines would not be made without them.

All the ingenuity we can muster in their design, all the care we give to their manufacture is to the end that you can install them, depend on them — and forget them.

# THE AMERICAN RADIO RELAY LEAGUE

## Directors

*President*  
EUGENE C. WOODRUFF.....W8CMP  
234 W. Fairmount Ave., State College, Pa.

*Vice-President*  
GEORGE W. BAILEY.....W1KH  
74 Webster Road, Weston, Mass.

*Canadian General Manager*  
ALEX REID.....VE3BE  
169 Logan Ave., St. Lambert, P. Q.

*Atlantic Division*  
WALTER BRADLEY MARTIN.....W3QV  
Box 612, Roslyn, Pa.

*Central Division*  
R. H. G. MATHEWS.....ex-W9ZN  
4534 Dover St., Chicago

*Dakota Division*  
FRED W. YOUNG.....W9MZN  
107 Hanover St., Mankato, Minn.

*Delta Division*  
E. RAY ARLEDGE.....W58I  
P.O. Box 286, Pine Bluff, Ark.

*Hudson Division*  
KENNETH T. HILL.....W2AHC  
115 Willow St., Douglaston, L. I., N. Y.

*Midwest Division*  
FLOYD E. NORWINE, JR.....W9EFC  
7405 Hiawatha Ave., Richmond Heights, Mo.

*New England Division*  
PERCY C. NOBLE.....W1BVR  
37 Broad St., Westfield, Mass.

*Northwestern Division*  
RALPH J. GIBBONS.....W7KV  
c/o United Air Lines, Portland, Ore.

*Pacific Division*  
J. L. McCARGAR.....W6EY  
66 Hamilton Pl., Oakland, Calif.

*Roanoke Division*  
H. J. CAVENESS.....W4DW  
State College Station, Raleigh, N. C.

*Rocky Mountain Division*  
GLEN R. GLASSCOCK.....W9FA  
2164 So. Corona St., Denver

*Southeastern Division*  
BENNETT R. ADAMS, JR.....W4EV  
1512 Grove Place, Homewood, Ala.

*Southwestern Division*  
CHARLES E. BLALACK.....W6GG  
1273 Main St., El Centro, Calif.

*West Gulf Division*  
WILLIAM A. GREEN.....W5BKH  
801 Ross St., Abilene, Texas

THE AMERICAN RADIO RELAY LEAGUE, INC., is a non-commercial association of radio amateurs, bonded for the promotion of interest in amateur radio communication and experimentation, for the relaying of messages by radio, for the advancement of the radio art and of the public welfare, for the representation of the radio amateur in legislative matters, and for the maintenance of fraternalism and a high standard of conduct.

It is an incorporated association without capital stock, chartered under the laws of Connecticut. Its affairs are governed by a Board of Directors, elected every two years by the general membership. The officers are elected or appointed by the Directors. The League is non-commercial and no one commercially engaged in the manufacture, sale or rental of radio apparatus is eligible to membership on its board.

"Of, by and for the amateur," it numbers within its ranks practically every worth-while amateur in the nation and has a history of glorious achievement as the standard-bearer in amateur affairs.

Inquiries regarding membership are solicited. A bona fide interest in amateur radio is the only essential qualification; ownership of a transmitting station and knowledge of the code are not prerequisite. Correspondence should be addressed to the Secretary.



HIRAM PERCY MAXIM, FIRST PRESIDENT

## Officers

*President*.....EUGENE C. WOODRUFF, W8CMP  
State College, Pa.

*Vice-President*.....GEORGE W. BAILEY, W1KH  
Weston, Mass.

*Secretary*.....KENNETH B. WARNER, W1EH  
West Hartford, Connecticut

*Treasurer*.....ARTHUR A. HEBERT, W1ES  
West Hartford, Connecticut

*Communications Mgr.*.....F. EDWARD HANDY, W1BDI  
West Hartford, Connecticut

*General Counsel*.....PAUL M. SEGAL  
1026 Woodward Building, Washington, D. C.

Address all general correspondence to the administrative headquarters at West Hartford, Connecticut.

# "IT SEEMS TO US —"

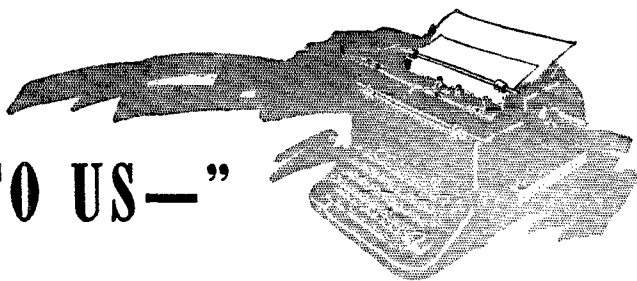

## POSITION REPORT

As we write, in early October, we are keenly conscious that fast-moving developments in the international situation may make hash of what we write before the printer's ink is dry. It has been that way the past two weeks. We can only do our best.

We have just returned from Washington, where we talked over the position of the amateur with officials in every branch of the government concerned with radio. We still feel assured that there is no present room for uneasiness about our situation, provided that we continue to behave ourselves. Officials watchfully ponder the whole communications picture, but there are no deep and foul plans to do away with us. They don't know what may happen to alter America's position in the international picture; they don't know what steps may later become necessary to protect our country's interests. But stories that there are intentions to close us down are completely untrue. The nation needs its radio amateurs as it never has before, and that fact is realized.

In the month since we presented the A.R.R.L. neutrality code the ether has rung to the retelling of that story on every band. By now it must be known to every amateur. And by now it is clear that only our prompt and voluntary adoption of that code, and our ability to show Washington that we were taking care of our own house, saved the day for us during the early unsettled period. *It continues to be of transcendent importance that we observe neutrality by refraining from discussing on the air any manifestation of the war and any subjects that might have military interest for an interceptor.* To the extent that you value your right to operate, let that be *your* code, un-faillingly!

## ABOUT INTERCEPTING

WE AMATEURS have trained ears and sensitive receivers, and our numbers blanket the nation. We are ready for any emergency job that might be entrusted to us. There have been reports in the press that amateurs were being appointed "radio detectives" — we're not sure what for — and some of us are simply busting to get going on such an assignment.

Sorry, fellows, but there is nothing stirring. There are no such jobs. The press stories are incorrect. The League has offered our services to the appropriate government agencies but

they are not needed. America is at peace with all the world. There is no situation existing that cannot be covered by the normal facilities of the government. The government says it wants no self-appointed vigilantes, no super-patriots going around chasing spies.

We are even less free than the ordinary citizen in such matters, for *the secrecy provisions of radio law are still in full force.* It is against the law to divulge the text of a message, or its general meaning, or even its existence. We must not appoint ourselves super-patriots and commence copying down everything that we can't understand, and reporting it. To do so will cause us about as much embarrassment as to violate neutrality ourselves. Frequency, calls and hours of course can be mentioned, but not the nature of a communication. Amateurs must not copy texts and send them to Hq. for study, because that constitutes divulging them. They may not send them to government agencies because these agencies have not requested and authorized it.

The foregoing refers to the authorized communications of government and licensed stations. The protection of the secrecy provisions does not extend to unlicensed stations operating in defiance of law. If amateurs hear an unlicensed station sending a message that violates U. S. neutrality, and if they are *sure* the station is unlicensed, they may report the matter in detail. But if it turns out to be the communication of an authorized station, the amateur is in great danger of being penalized for violating the secrecy provisions. (And — while it's an academic point — that would be true even if the text violated neutrality.) We would be praised for turning in an unlicensed station engaging in unauthorized activities, but there are surely not many such, and the risk is great that we would only be intercepting a routine military tactical drill and that the result would be a suspension for the reporter and a black eye for all of us.

Now under these circumstances, what should we do? We suggest that we "lay off." We may listen and keep our ears open but we counsel every amateur to sit tight unless he is dead sure what he's talking about. We repeat that there is no large situation needing our assistance. Existing agencies can deal with it. Let's stick to our own operating.

While amateur communications also have the protection of the secrecy provisions, this

doesn't bar an amateur from communicating by radio or mail with another ham who is "talking about the war," to call our code to his attention and ask his compliance. We request all hams to help us make sure that our house is clean as clean.

**FORWARD!**

LET's summarize: The period of jitters is over. If we'll only carry on as we were doing

four months ago, before this war was imminent, we can do so indefinitely. Let us show calmness and restraint. Let us squash stories that anything is going to happen to amateur radio. We have a mighty busy and interesting winter ahead of us. Let us have only one big rule for ourselves: to ignore the w-r completely as a topic of conversation and action!

K. B. W.

---

★ **SPLATTER** ★

---

OF PARTICULAR interest to the u.h.f. gang will be the description of W1XEH's coaxial antenna by Ed. Sanders. This antenna, besides being an original piece of design, is intriguing because it is right down the alley of a ham experimenter: a pair of tin shears and some gutter pipe, and you have the essentials for a highly effective general coverage radiator.

Phil "Gil" Gildersleeve, W1CJD, has been making *QST* cartoons for over a decade. In 1931 he did a series of cartoon strips depicting the maneuvers of the Podunk Hollow gang for *QST* covers. That this series was well liked is evidenced by the fact that fellows still ask, "When are you going to have some more cartoon covers?" For the past two years Gil has forsaken Gildersleeve-on-the-Connecticut for life among the banana boats, pounding brass and air-mailing cartoons between ports. We are indebted to W1DDB for a self-portrait that Gil made and exchanged with DDB, another artist, some years ago.



That annual contest, the Sweepstakes, by far the most popular national contest, is announced

in this issue. Besides the distinction that comes from being a Section winner, there is an award to be made — and it is a honey. It is a chromium tie holder with diamond-shaped medallion. The winner's call is inscribed on one side of the diamond and the name of the contest on the other.

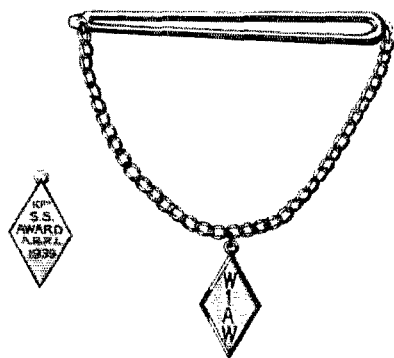

This design was made and produced by The Robbins Company and is one of the neatest we have ever seen. An award will be made to both c.w. and 'phone participants in every A.R.R.L. section.

**FEEDBACK**

**Equation 2, p. 40, October *QST***

This equation should read:

$$X_2 = \sqrt{R_1 R_2 - R_2^2}$$

**P. 39, October *QST***

If there is anyone, besides the Managing Editor, who didn't catch this one (a couple more states and we would have WAS), that halftone is upside down.

— — — — —  
**Our Cover**

This is a rather shuffled array of gear comprising a portable station that was built by Clint DeSoto for the new *Handbook*, about to be released.

# More Thoughts on Effective Antennas

**Proven Designs for 14, 28 and 56 Mc.; Four-Element  
Beam Supports; Tuning the Array**

**BY ARTHUR H. LYNCH,\* W2DKJ**

FOR many years we have held the idea that amateurs generally were not taking full advantage of the better performance which could be obtained from a given transmitter and receiver by using antennas suitable for the particular job the station was intended to do. It has been a source of great satisfaction to find that the past few years have focused more and more attention on that subject. As most of us now know, it is easier to maintain contact between two given stations, with reasonably low power but equipped with suitable beam antennas pointed at each other, than it would be with several times the power and the older types of aerials—and very much cheaper.

Many of the commercial companies have been using large rhombic antennas to good advantage for some time, and the reports from those amateurs who are lucky enough to have the space available to duplicate them have been so glowing that the rest of us have burned up with envy. Since radio began, we have gone about our business by starting with something rather large and gradually cutting and trimming until much more efficiency has been brought out of equipment which, in many cases, is less than a quarter the size of the original. It is therefore with a feeling of confidence, founded on the solution of many knotty problems in the past, that some of the more pioneering souls among hams have attempted to produce small antennas which would approach the performance of the envied larger ones, but which could be used by those of us who are not blessed with many acres.

In presenting the following facts—and sufficient time has elapsed to be certain that they are facts—we make no claim for any particular originality, other than certain portions of the mechanical design which seem to contribute to the ease and the permanence of the final assemblies. As was the case with the former articles which we prepared for *QST*, the present one combines our own investigations with those of many others, and we trust that the present digest will bring the same hearty response which came from the past efforts.

\*Managing Director, W2USA Radio Club, N. Y. World's Fair, 1939.

The 56-Mc. antenna at W2USA, dimensions of which are given in Fig. 1. Note the World's Fair scenery. (Photo by W2AHC)

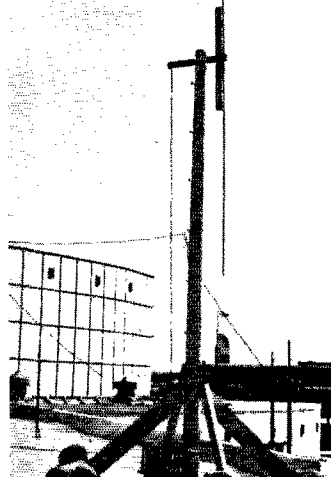

## Five Meters

Like many other amateurs whose property is not large enough to warrant extensive antennas on the lower frequencies, we have been confining our own investigations to the five- and ten-meter bands. It is fairly well understood that most of the conditions which obtain on the higher frequencies can be duplicated on the lower frequencies, giving due consideration to some of the important factors such as height above ground and freedom from other objects, when the dimensions are increased to produce similar results on the lower frequencies.

This is both an advantage and a handicap. It is an advantage for the reason that the adjustments become less critical as we go lower in frequency. Adjusting a matching stub on 112 megacycles is much more of a precise undertaking than doing so on an antenna designed for twenty-meter operation. It is a handicap for the reason that aerials approach in actual performance the theoretical only when they are sufficiently above ground and well in the clear, so far as other objects are concerned. The latter fact becomes more important as the natural radiation or absorption qualities of the objects within the field of the antenna increase. Well known as these facts are, they are sometimes forgotten.

Based upon the informative article on the "Extended Double-Zepp Antenna," by Hugo Ro-

Besides giving some timely electrical dope on antennas useful in the 5-20 meter range, the author shows how, with a few simple changes, the framework described in a previous *QST* article can be adapted to support multi-element rotary beams.

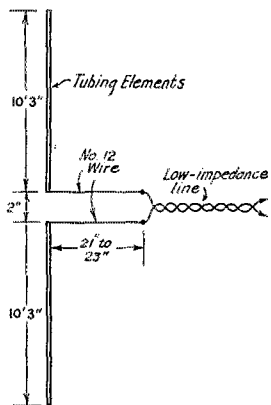

Fig. 1 (left) — The "extended double Zepp" mounted vertically for 56-Mc. work and fed by twisted pair line, as used at W2USA.

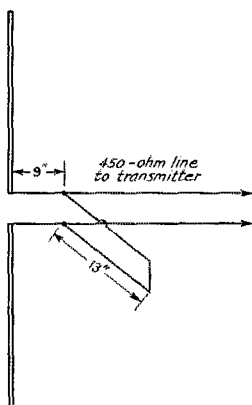

Fig. 2 (right) — The antenna system of Fig. 1 matched to an open-wire line.

mander, W2NB,<sup>1</sup> Frank Lester, W2AMJ, and Lawrence Cockaday, W2JCY have applied the same principles to five meters. Most of the Romander article had to do with horizontal aerials, while most of the five-meter activity is on vertical units. There was no reason to believe that the change of plane would change the overall results very much. Actual experiment, however, indicated that a very considerable change in the dimensions suggested by Romander would be necessary if the best results were to be obtained on five meters with a vertical antenna. This type of antenna has been used to better advantage by both Lester and Cockaday than any antenna they had previously used for five-meter operation. Equally improved performance has been the experience of all the other stations which have installed this very simple aerial, including the one which has been in use at W2USA ever since that station has been on the air, which will be nearly a year by the time this article is published. (The five-meter transmitter at the N. Y. World's Fair was operated as W2DKJ/2, until the issuance of the W2USA call.)

The arrangement shown in Fig. 1 is in use at W2USA at present. It is frowned upon by both Lester and Cockaday, for the reason that a twisted pair is used to feed it. They claim that the losses in that form of transmission line are too great. We agree that some gain in efficiency could be brought about by the use of a spaced transmission line on the high frequencies, but there are certain limiting factors over which we have no control, and we are forced to take the loss and like it. In spite of loss in the line, the convenience warrants its use in any number of places and we do know that we are getting better results than would be possible with a half-wave antenna delta-matched to an open line, a type commonly used for five-meter operation. That fact has been borne out at all of the stations which have made the change. Just how much better the open-wire

arrangement would be, we cannot say, but we do everything we want to do with our present arrangement.<sup>2</sup>

All of the important dimensions (for the middle of the band) will be found in the drawings, and the picture of the antenna in use at W2USA indicates how it is done. Of course dimensions can be altered and standing waves can be eliminated in the usual manner. For all practical purposes, however, we know that the system may be set up just as shown and excellent results will be obtained.

The second figure gives all the necessary information for the use of an open line of the type used by both Lester and Cockaday. For the operator who is acquainted with antenna and transmission-line tuning and pruning, there will be no difficulty in bringing the whole system to peak performance; for operators who do not have such experience, we suggest the setup just as it is shown. Any number of installations have been made in just that manner with very gratifying results in every case.

### Beam Antennas

There is an old saying: "You don't get something for nothing — for long." It is pretty well borne out in connection with the use of beam aerials for improving the performance of any radio station. We hear a lot of conversation on the air and we read much about the "gain" to be obtained from a given antenna system. To be sure, the use of a suitable antenna system will improve the performance of any station. But if the gain

<sup>1</sup> Romander, "The Extended Double-Zepp Antenna," *QST*, June, 1938.

<sup>2</sup> Depending upon the spacing of the open-wire line and the way in which it is brought from the antenna, radiation from the line may cause the radiation angle to shift upward, with consequent reduction of the effectiveness of the antenna on 56 Mc. This accounts for the superiority of the concentric line antenna over the "J," for example. Since radiation is negligible from a twisted pair, the overall performance of the system may not compare as unfavorably with an antenna fed by an open line as might be thought from consideration of the considerably higher losses in the rubber-insulated line. — *Editor*

for certain antenna systems were actually what is claimed for them, we should be well on the road to the solution of the perpetual motion problem.

The simplest way to understand why beam aeri-als are superior to the ordinary kind is to consider the analogy of an automobile headlight. An ordinary 32-candle-power bulb, if used without reflectors and hung directly from the ceiling of the ordinary room, would produce anything but good illumination. And, even in this case, there is a certain amount of reflection from the bright ceiling. But if we take the same bulb and place it in front of a good reflector, it can be made to produce a beam which will have the equivalent of several hundred candle power, in the direct line of the beam.

If we move the lamp toward or away from the central portion of the reflector, within certain limits, we will increase or decrease the width of the beam. As the width of the beam is increased the intensity of the light in the direction of the beam is cut down, and as the beam is sharpened the intensity is increased. It is easy to see that the light intensity at a distance of say thirty feet from the lamp would be much greater for a highly directive beam than for the lamp used without any reflector.

Additional increase in the luminosity of the beam is produced by the introduction of one or more lenses ahead of the lamp, as is done with the common flashlight. We know that we can operate an ordinary flashlight in a dark room without any reflector or lens and the light it produces will not bother our eyes, even if we look directly into it. The same bulb, with suitable reflector and lens, when properly adjusted to produce a sharp beam will give a blinding light at more than two hundred yards.

And so it goes with the radio beam. Our transmitter, tuned to the  $n$ th degree, may well be considered the flashlight battery; the regular antenna, or radiator, the flashlight bulb; the reflector remains the reflector and the lens of the flashlight is replaced by what we call the director. We do not get any additional power from the use of suitably designed beams; what we do is use the available power more efficiently. We put it where we want it and where it will be useful, without

having the light shining in other people's eyes. On the other hand, when similar antenna systems are used for receiving we have the advantage of receiving with greatest intensity from the desired direction, with great attenuation of signals coming from undesired directions.

Without delving into the complications of the underlying theory of antenna design we get right down to the details of an antenna system which has given remarkable results in the 14-Mc. band. Certain mechanical defects which showed up in an early model of this antenna have been overcome in the design shown in Fig. 3.

### Supports

The "ladder" type of construction has given satisfaction with 14-Mc. beams when the number of elements has not exceeded three. However, when four elements have been used, there has been noticeable warping of the central structure, with resultant disalignment of the elements which in turn has brought about a serious reduction of the overall efficiency of the beam. In many instances the pattern, originally of a very fine character, has been so badly distorted that the front-to-back signal ratio has been more than cut in half, and signal strength off the ends, which would normally be almost zero, has come up to a point which competes with the other angles. It was with a view to preventing such warping, without going to a mechanical assembly which would be unduly heavy, that we developed the support shown in Fig. 3.

Retracing our steps to the framework we described in October, 1938, *QST*,<sup>3</sup> and considering the additions we made to that original design to use it for a three-element beam, we decided that it would be a reasonably simple job to use the same design for two new supporting frames, one for a four-element 28-Mc. array and the other for a four-element 14-Mc. array.

For 14 Mc., it was only necessary to extend the length of "D," in our original Fig. 3,<sup>3</sup> and add two additional "E" sections which are used to carry the two additional elements. Additional transverse struts have been added, similar to those shown as "F," in the first drawing. Exten-

<sup>3</sup> Lynch, "Some Thoughts on Rotary Beam Antennas," *QST*, October, 1938.

The framework for the four-element 14-Mc. beam, the lighter portions being the additions to the original frame described in October, 1938, *QST*. Shown in the author's yard prior to its installation at W2USA. W2BRI in attendance.

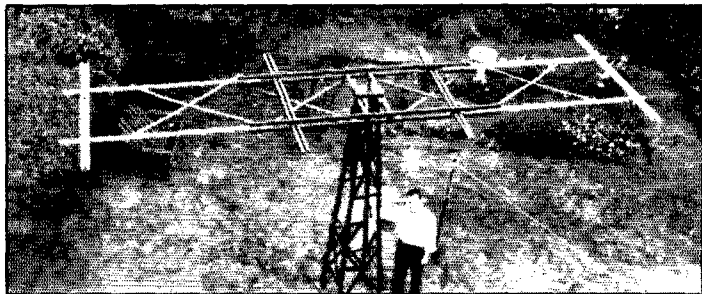

sion of the long arms of the beam is simplified by using single extensions instead of double rails, and this also has the effect of holding the weight down materially. The transverse struts have been made very much lighter than in the original design to hold the weight down, and both strength and rigidity are attained by the use of the raised guy wires. And that brings up a few points which are well worth considering.

### Guying

In addition to providing unusual strength with very light weight, the use of the proper sort of guying arrangement gives us very satisfactory control over the positions of the outside elements. It is had practice to run the guys through the central support and carry them to more than one of the outside points; each guy should be terminated at the central support. Then, by proper adjustment of the turnbuckles, we can raise or lower the outside elements with relation to the two central units and we can raise or lower the outside ends with relation to the central axis. Thus all the elements can be maintained in the same plane, even if a certain amount of "set" occurs after the beam has been completed. As all the turnbuckles are located near the center of the beam framework, suitable adjustments may be made before the assembly goes into the air.

In our own case, certain precautions were taken which we believe to be well worthwhile. For in-

stance, we chose the National Type AA-5 compression-type strain insulators for making up the guys. They are very small and therefore offer very little wind resistance; furthermore, they are very light. For the guy wires we used No. 12 Copperweld. It is steel wire with a copper coating, and is also enameled. It is not the easiest wire to work with since it is very stiff, but a couple of pairs of gas pliers did the trick for us in good shape. The turnbuckles we selected are light, but well plated, so as to withstand the weather.

We found it convenient to use ringbolts for the guy terminations, as they served the purpose of holding the various portions of the framework together, along with their function of providing a suitable guy anchorage. Like all the other metal parts, they should be weather-resistant.

### Lengths and Spacings

After long experience with various types of beam antennas, as well as from comparing notes with other workers, we have come to the conclusion that the formulas to be given constitute a very good starting point for the adjustment of any antenna. It must be borne in mind that no formula will apply under all conditions. The height of the aerial above ground, the proximity, as well as the character, of surrounding objects and other variables of a similar nature, will alter cases to a greater or lesser degree. The character of the ground above which the antenna is to be

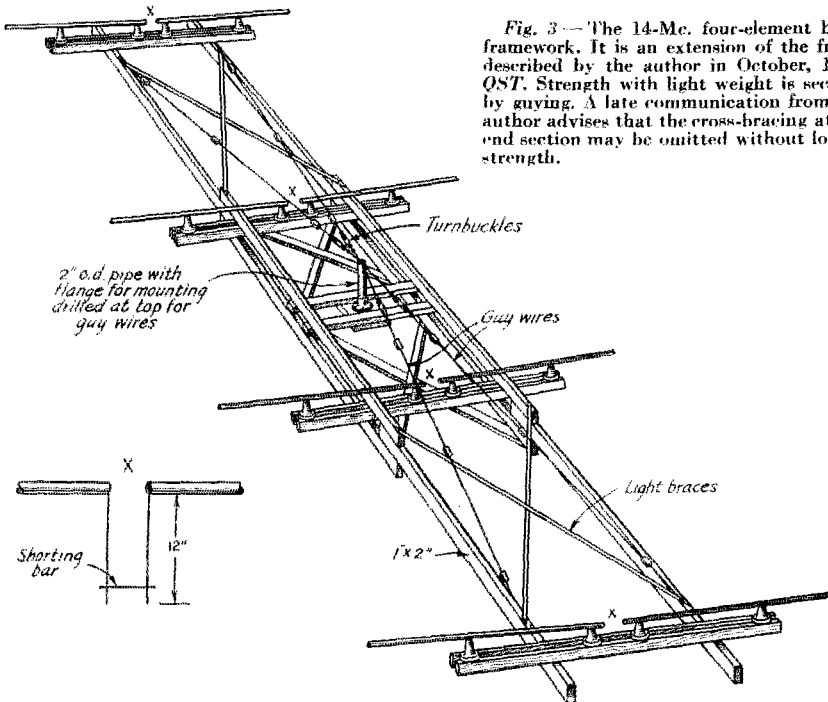

Fig. 3 — The 14-Mc. four-element beam framework. It is an extension of the frame described by the author in October, 1938, QST. Strength with light weight is secured by guying. A late communication from the author advises that the cross-bracing at the end section may be omitted without loss of strength.



erected will have a very important effect upon its final performance. None of these things can be determined with much accuracy in advance. So, while the tables which most of us are wont to mention so glibly are correct for a theoretically perfect group of circumstances, they will hardly fill the bill in the average case. For that reason we suggest them as nothing more than the starting point.

Since all the dimensions for the various portions of the 14-Mc. band are so much alike, it is possible to utilize a supporting framework with fixed spacing between the elements, compensating for any variations by the adjustment of the small tuning stubs, as outlined later on.

The formulas are:

$$R = 492,000/f \text{ (kc.)}$$

$$A = 0.95R$$

$$D = 0.925R$$

$$R \text{ to } A = 0.1 \times 2R$$

$$A \text{ to } D = 0.95 \times 0.1 \times 2R$$

$$D \text{ to } D = 0.95 \times 0.1 \times 2R$$

All dimensions are in feet.  $R$  is the length of the reflector, found by dividing the constant 492,000 by the frequency in kilocycles;  $A$  is the actual antenna, or driven element;  $D$  and  $D$  are the directors. From these formulas we have the following approximate figures for the ends and center of the 14-Mc. 'phone band:

	14,150 kc.	14,200 kc.	14,250 kc.
R . . . . .	34' 9 $\frac{1}{4}$ "	34' 8"	34' 6 $\frac{1}{2}$ "
A . . . . .	33'	32' 10 $\frac{3}{4}$ "	32' 9 $\frac{3}{4}$ "
D . . . . .	32' 1 $\frac{1}{2}$ "	32' 1 $\frac{1}{2}$ "	31' 11 $\frac{1}{4}$ "
R to A . . . . .	6' 11"	6' 10"	6' 9"
A to D . . . . .	6' 7"	6' 6 $\frac{1}{2}$ "	6' 6"
D to D . . . . .	6' 7"	6' 6 $\frac{1}{2}$ "	6' 6"

Except for slight differences in the lengths of the various elements, it will be seen that variations in the other portions of the assembly, for frequencies within the 14-Mc. 'phone band, are very small indeed. They may be neglected, as we have said, and compensated for by the adjustment of the stubs in the various elements.

#### Tuning the 14-Mc. Four-Element Beam

Although others have been able to get satisfactory results by tuning their four-element arrays while they were on the ground and then making slight adjustments to bring them "on the nose" when they got them into the air, we have never had much luck with that procedure. Then, too, we set about the job with misgivings for the reason that we knew the adjustment of any one of the elements would have a certain effect upon all the others. The task appears to be much more difficult than it really is.

For the following complete information for the tuning of this type of beam, we are indebted to James Tynan, W2BR1, who actually did the work. The idea of using the short tuning stubs has

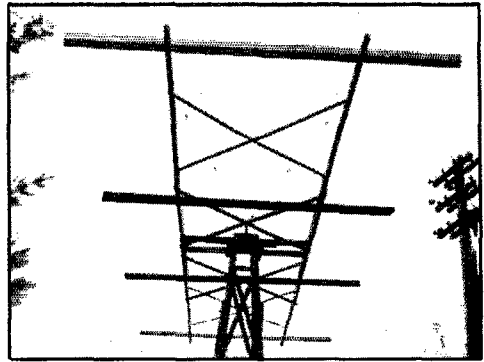

An end view of the four-element frame. Note the insulators in the guy wires supporting the end sections.

always appealed very strongly to us since we first ran across it.<sup>4</sup>

All the elements were mounted, in accordance with the dimensions for operation on 14,200 kc. as outlined in the table given previously. None of the shorting bars are attached to the short stubs of the reflector or either director until after the radiator has been suitably adjusted. The method used to accomplish this is to set the radiator to the indicated length, which figure includes the length of the two halves plus fourteen inches. This latter figure is made up by considering the shorting bar to be half way down the stub, the two sides of which are two inches apart. That permits us to raise or lower the shorting bar six inches from the central position, which has proved to be ample. The stubs themselves consist of two separate wires, each a foot long.

While it is possible to do the tuning by having another person listen in for the signals from the beam to be adjusted, we believe the following will be much simpler and more satisfactory.

Considering that we are to use a delta matching transformer for the transmission-line, the radiator system all the way down to the final tank will have the general appearance of Fig. 4. The number of turns required to couple the line to the final amplifier will be determined by the impedance of the line; in the case of the 600-ohm line, four turns will do very well. If the center of the coupling coil is grounded, as indicated, very satisfactory lightning protection is provided. It will be seen that the wires which form the delta will be attached about 22 inches from the inner extremities of the two units which form the radiator. The equilateral triangle generally used seems to be thrown out of kilter, but if we consider that the portion of the short stub which is to be used is actually added to the center of the matching transformer, it will be seen that the proportions of the triangle are fairly well kept.

Now, we set up a good field-strength meter, a

<sup>4</sup>Smith, "Practical Design of Close-Spaced Uni-Directional Arrays," *Radio*, June, 1938.

couple of wavelengths from the radiator. It is worth mentioning that the antenna used in conjunction with the field-strength meter, should be in the same plane as the antenna. However, it is not necessary to have it at the same height, though this is desirable. If we are using the antenna in a horizontal plane the field-strength meter should have its antenna in a horizontal plane, and *vice versa*.

Now, the radiator is energized with low power — just enough to provide suitable readings on the field-strength meter. Naturally, the radiator and the field-strength meter antenna should be parallel. The shorting bar is raised and lowered until the greatest reading on the field-strength meter is obtained. This adjustment is not too critical and may be accomplished by sliding the bar up and down by hand — though it is important, even with low power, to use gloves. This is just as true when we are working on the other elements as it is when we are adjusting the directly-fed element.

Next, swing the beam around to a position where the reflector is between the radiator and the field-strength meter, attach the shorting bar to the reflector stub and adjust for the *lowest* reading on field-strength meter.

Now swing the beam around again so that it is pointing at the field-strength meter and manipulate the stub of the first director until the greatest field strength is indicated on the meter. In some instances it will be found, even when this adjustment is made with fifty watts or less going into the radiator, that the field-strength meter will have to be shunted to prevent its going off scale. Some experimenters advocate the reverse procedure, in which the reflector remains between the driven radiator and the field-strength meter and the director is adjusted until the lowest reading,

indicating the greatest rejection, is obtained. Both methods will work.

Finally, coming to the second director, the stub of that element is adjusted until the highest reading is obtained on the field-strength meter. At this point, it will be found that the front-to-back ratio of the beam is tremendous and no further adjustments need be made. However, by trimming here and there, it will be found that even greater increase is made possible. There is no cheaper way of improving the efficiency of a transmitter. The power gain which these few, easy adjustments make possible is highly gratifying.

### Standing Waves

Above, we mentioned that the field-strength meter should be a couple of wavelengths or more from the radiator. One important reason for this precaution is the fact that, with the transmission line tied to the antenna in the manner suggested for starting the tests, it is very likely to be out of adjustment as far as impedance match is concerned and will no doubt have some standing waves and may be somewhat unbalanced. If that is the case, and the field-strength meter is too close to the line, the meter will respond to radiation from the line in addition to that from the radiator, resulting in readings which are likely to be inaccurate.

Except for the misinformation they would give us with regard to the proper adjustment, it is doubtful if standing waves on the line would have any serious effect on the overall performance of the beam. However, they are very easy to eliminate and, if we are going to operate with high power in a congested area, the possibility of interference with broadcast reception can be reduced by eliminating them.

Six-volt flashlight bulbs coupled to the line by a loop of wire will do the trick. The amount of wire in each of the loops will depend on the amount of power in the line. In our case, a couple of inches was all that was necessary, with 500 watts input to the transmitter. First locate a point on the line where the bulb lights up brilliantly and clip one bulb there. Place a second bulb a quarter wavelength along the line from the first. This point is easy to locate by finding the spot where the bulb shows the least brilliancy.

Now it is only necessary to increase or decrease the distance between the points of the delta where they join the radiator until the brilliancy of the two bulbs is equal.

### The 28-Mc. Beam

The only essential differences between the new four-element 28-Mc. beam frame and our original framework for a 14-Mc. W8JK array are in the length of the longitudinal sections and the fact that we use single wooden supports for the ele-

(Continued on page 116)

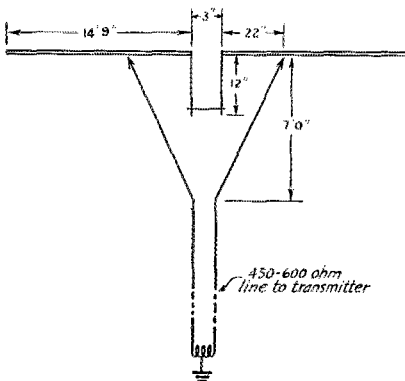
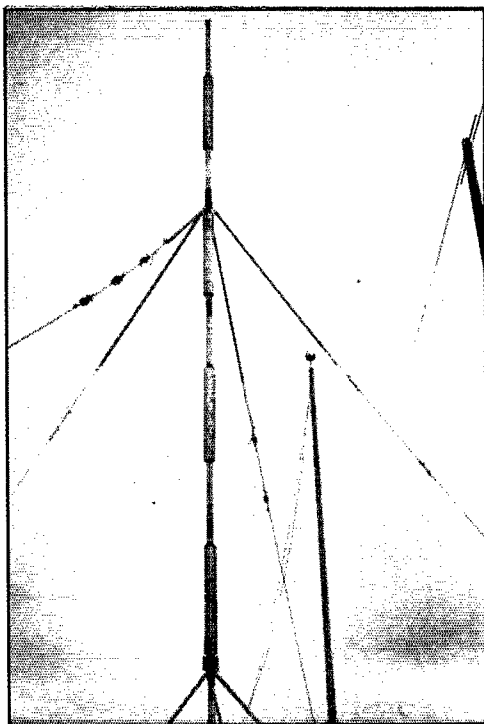

Fig. 4 — Dimensions of the delta matching system, for 14,250 kc. Slight adjustment of the taps on the antenna element may be necessary to eliminate standing waves, as described in the text. The coupling coil at the transmitter may be grounded at the center to reduce lightning hazard.

W1XEH, the u.h.f. transmitter of WTIC, originally was installed a few years ago to provide a continuous 63.5-Mc. signal for recording at Harvard, in cooperation with the late Ross A. Hull's program for investigation of air-mass bending of u.h.f. waves. The antenna described here has given such satisfactory performance, in comparison to the conventional multi-element array, that it certainly warrants trial by amateurs interested in improving the strength of their 56-Mc. signals. Constructed of tinsmith's materials, its appearance is far from conventional.

### A Novel Four-Element Collinear Array for 56-Mc. Work

The stacked coaxial radiator at W1XEH has four in-phase elements made of downspouting with sheet-metal sleeves. The downspouting serves as transmission line, part of the radiating system, and part of the phase-reversing stubs. It is all one piece — no insulated joints are necessary.



## Stacking Coaxial Antennas

BY EDWIN R. SANDERS\*

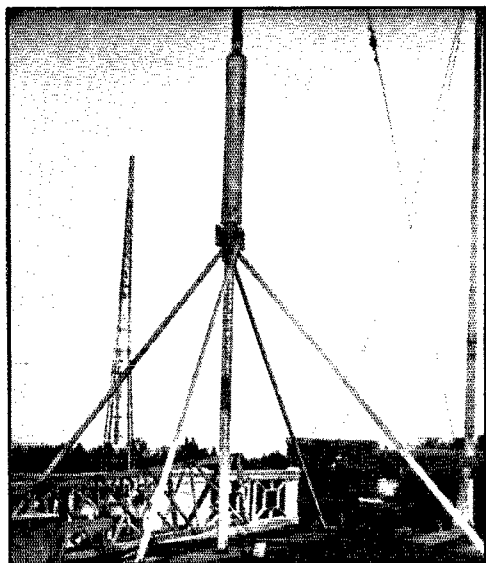

THE original antenna at W1XEH was a bi-directional array toward New York and Boston, hung from a halyard between two poles. Arrays hung in this fashion must be light in weight and so are susceptible to damage by storms. Further, the insulators were located at voltage loops, so that rain and snow changed the characteristics of the antenna so much that the final stage was sadly detuned and mismatched in bad weather.

To overcome these defects a second antenna, an 8-element array 4 elements high and two wide, supported from a central lattice tower, was constructed. The phasing sections were made of  $\frac{3}{4}$ -inch I.D. hard copper tubing and supported from the tower by standoff insulators near their centers where the voltage is low. The antenna elements were  $\frac{1}{2}$ -inch I.D. hard copper tubing run vertically between the ends of the feeders. Since the phasing sections were very stiff no insulators were needed at the junctions with the antenna elements, and since there was no feeder

\* Ex-WIEDY, Development Engineer, WTIC; 179 Prospect St., Bloomfield, Conn.

← A close-up of one section of the antenna.

at the top or bottom of the array the upper and lower elements were supported at their centers, where the voltage is low, from wooden crossarms and standoff insulator, as shown in the photograph.

The array was excited through an open line of 3/16 copper tubing spaced 4 inches. This was pulled tight with turnbuckles so that spans of 25 feet were permissible without the use of spreaders. The line was supported by metallic insulators consisting of 1/4-wave shorted stubs. A matching stub was used to couple the line to the middle of the center horizontal phasing section.

This antenna was a great improvement in the matter of changes because of ice and snow. However, the hurricane of 1938 took it down rather handily.

About this time the coaxial antenna<sup>1</sup> was announced. We have long adhered to the principle that a high order of vertical directivity is needed at 5 meters. We decided to stack four coaxials vertically.

Four ten-foot sections of 3-inch galvanized iron

<sup>1</sup> Arnold B. Bailey, *Pick-ups*, September, 1938; J. J. Long, "The Coaxial Vertical Radiator," *QST*, January, 1939.

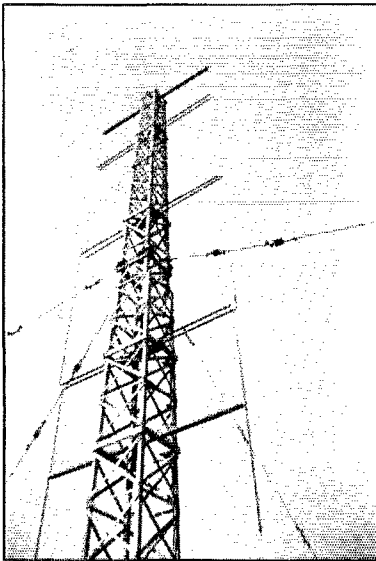

This is the 8-element array which the present coaxial antenna has replaced, giving as good signal in all horizontal directions as the directive system in its best direction.

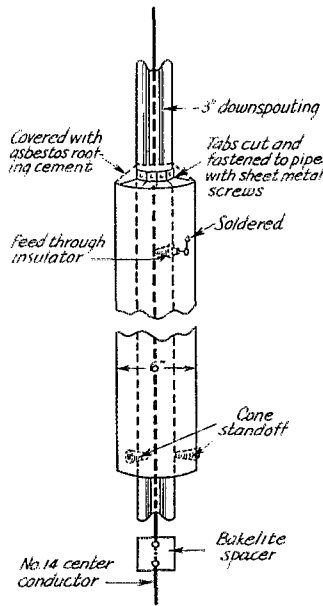

Fig. 1—The constructional details are shown in this drawing. The cone standoffs are mounted about three inches up inside the sleeve for protection from rain; the inner ends are not fastened to the pipe but simply rest in the corrugations. The long piece of the feed-through insulator should be fastened to the wire at the right point before the wire is pulled through the pipe, so that the lead can be fished through the hole when the inner wire conductor is in place. This must be done before the sheet-metal sleeve is installed on the pipe.

conductor pipe were "slipped" together to lap 8 inches and fastened with sheet metal screws. Since the spouting is only intended to lap a few inches, special treatment is needed here to get the longer lap which is necessary for good mechanical strength. The diameter of the pipe which is to be the inside member of the lap must be made smaller than normal for

the length of the lap. This can be done by placing a thin piece of wood longitudinally in the bottom of the groove and hammering so that the grooves tend to "pinch" together slightly. Treat each groove similarly. The two sections of pipe can be slipped together by holding the inner one firmly and having a helper pound on the opposite end of the outer section, using a block of wood to prevent damage to the hammered end. The lap should be made so that the top section slides over the one below it to keep water out of the inside. A visit to the kitchenware department of the "5 and 10" will provide a cap for the top.

The lower half of each antenna element is a sleeve of galvanized iron 6 inches in diameter and 95% of 1/4-wavelength long. The top end is slit and bent to fit around the conductor pipe where it is fastened with sheet metal screws and solder as shown in Fig. 2. A coat of roof cement or the asbestos-base variety keeps the inside dry. The bottom of the sleeve is spaced from the pipe by three standoff insulators fastened only to the outer sleeve and resting in the bottoms of the grooves in the pipe. The sleeves are so spaced on the pipe that the element length, bottom of one sleeve to bottom of the next, is 95% of a half wave.

It is now apparent that we have a Franklin antenna (in phase collinear elements) in which the phase reversing stubs are coaxial instead of spaced, and the stubs are turned up inside the elements.

It is desirable to feed the antenna from the top to insure a maximum of energy in the top elements, since these are the most effective from a radiation standpoint due to their elevation. On

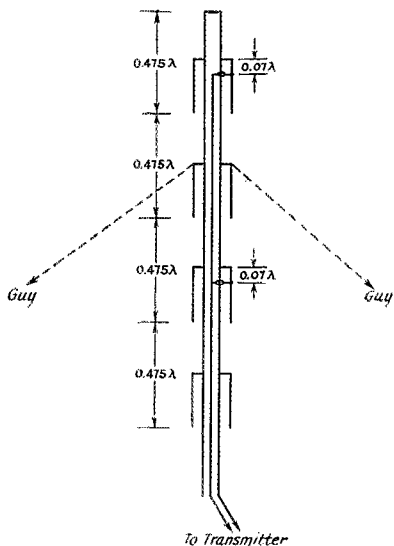

Fig. 2—The electrical arrangement of the four-element coaxial antenna. The top element and the third from the top are directly driven. Dimensions in feet can be found by applying the factors given in the drawing to  $492/\text{freq. (Mc.)}$ . The concentric line may be continued to the transmitter or matched into another line by any of the conventional methods suitable for the purpose.

the other hand we were told of the excellent isolation of elements produced with coaxial stubs and we wanted some energy in the lower elements. We decided to feed both the top sleeve and the third from the top. Thus the top element is driven directly, while the second from the top can be considered to be excited as an end-fed half-wave element through an inverted quarter-wave stub at the top. The third and fourth sections duplicate the first and second.

Since all the elements are to be fed in phase and these two stubs are approximately one wavelength apart they may both be connected to the line and will be effectively in parallel. The pipe is used for a transmission line of about 220 ohms by stringing a No. 14 wire down its center. The wire is kept central by squares of bakelite panel cut to slide in the grooves of the pipe. These are fastened to the wire at 2-foot intervals by drilling two holes in the bakelite and feeding the wire in one and out the other, as shown in Fig. 2. Care in the use of sheet metal screws must be used to prevent fouling the groove for these spacers; that is, at least one pair of diametrically-opposite grooves must be clear of screws for the entire length of the antenna. The bakelite spacers should be cut slightly small so that they will pass through the laps without binding. In pulling the wire through the pipe, start from the proper end so that there is no danger that the spacers will catch on the edge of the inner pipe at a lap joint. The center

wire is attached to the outer sleeve after going through a lead-through insulator in the side of the pipe. The point of feeder attachment to the sleeve is figured for about 440 ohms so the two loads in parallel will match the transmission line of 220 ohms. There is, of course, a slight mismatch on the last section of line, between the two directly-driven elements, but it is not serious.

The photographs show the 8-foot fir sticks used for guy wire insulators to help keep the guys out of the argument. The guys should be attached  $2/3$  of the way up and at a low-voltage point. The center of the second element from the top was used so there is 11 feet above the guys and 19 feet between the guys and the bottom braces shown in the photograph. The 3-inch pipe will stand a 70 m.p.h. wind before buckling.

Reports on the signal indicate that even though this antenna radiates equally well in all horizontal directions and has only half as many elements as the previously-used 8-element array, the signal strength is as high as that from the directional array on the center of its lobe of maximum radiation.

## Strays

Minus the time to put up another antenna after a change of location, I hooked the bed-springs to antenna tank coil link coupled to the final. The final loaded up nicely and, with 100-watts input, K6OXJ gave me S7 on 40 in the daytime. Worked several others with good reports.

— W6NCO

## Silent Keys

IT IS with deep regret that we record the passing of these amateurs:

- George J. Besnah, ex-W9GB, Appleton, Wis.
- Max Brown, W5FPI, Pine Bluff, Ark.
- Vincent L. Crawford, W5GVB, Texarkana, Ark.
- Clyde A. Gardner, W6KOT, Los Angeles, Calif.
- Wendelin J. Gunther, W9TOD, Des Plaines, Ill.
- James Lewis Haynie, W5GZE, Texarkana, Ark.
- Sullivan Herring, W5GHM-W4ESI, Clinton, N. C.
- Morris L. Hoag, W8KMA, Ogden, Utah
- Warren F. Jepson, W1NB, Melrose, Mass.
- Paul V. Mayer, W2JGO, West New York, N. J.
- George Robinson, W9MMU, Lombard, Ill.
- A. M. Venne, Jr., W9TCM, Hannibal, Mo.

# A Simple Freqmeter-Monitor

*Using Low-Drain Tubes for Low Drift*

BY H. S. BRITT,\* W7CQE

**T**HE prime requisite for a good frequency meter is stability. However, there is one kind of instability that is very difficult to avoid with the ordinary heater-type tubes, especially when the tube and associated parts are enclosed in a metallic cabinet. This is the frequency drift due to the heat from the tube itself, which manifests itself as a quite rapid drift when the tube is first turned on and then more gradually as the heat is transmitted to other parts, so that the oscillator does not settle down for quite a time. In fact, the statement is made in some articles that, for greatest accuracy, the meter should be left running a half hour before taking readings.

Using a low-drain battery-type tube as an oscillator practically eliminates this drift. The filament power required is so low that the temperature rise of the tube is not noticeable, and the readings may be taken at once. Against this, of course, are the disadvantages of batteries, but in the freq-meter-monitor to be described, these disadvantages are minimized.

Referring to the diagram, there is nothing novel in the circuit itself. The oscillator uses the 1N5G, and filament supply for this tube is obtained from a single dry cell, while the remainder of the power requirements are satisfied by a separate external a.c. power supply. An ordinary

\* Box 3, Newberg, Oregon.

dry cell should give something like 1000 hours of service here.

## Construction

$L_1$  consists of  $36\frac{1}{2}$  turns of No. 22 enameled wire, wound on a  $1\frac{1}{2}$ " coil form which sets in a separate ceramic socket. The length of winding is 1.4 inches and the cathode tap is 11.4 turns from the ground end.  $L_2$  is 11.4 turns of No. 22 d.s.c., wound over the corresponding part of  $L_1$ . The grid end of  $L_1$  is not taken out through the socket but is terminated at a small machine screw passing through a hole drilled in the form near the upper rim.

$C_1$  is a Centralab ceramic capacitor with a negative temperature coefficient to compensate for changes in temperatures. To determine the necessary coefficient, the meter should be put in operation without the compensator and a series of observations made to determine the change in frequency per degree of temperature change. From this the necessary compensation can be computed. (Data sheets on these capacitors may be obtained from the manufacturers which will give a convenient formula for working this out as well as other information for ordering.) For closest compensation, the capacitor should be ordered to the next even figure above the exact value worked out from the tests, then, if it is found that after putting the compensator in the circuit (as shown by the full lines in the diagram), the meter is over-compensated, the grid terminal of the compensator may be tapped down on the coil a few turns, until by trial the compensation is made as close as desired. These capacitors are very small, actually less than the size of a  $\frac{1}{2}$ -watt resistor, and hence are very easy to introduce into the circuit.

$C_4$  is a  $35\text{-}\mu\text{fd.}$  variable, controlled by the small knob on the panel to the left of the tuning dial. This condenser's shaft extends about  $\frac{1}{2}$  inch back of the rear bearing. A collar on this shaft, held by a long set-screw, forms an adjustable stop, and it is set so that the capacity range of  $C_4$  is slightly less than that of  $C_3$ , the main tuning condenser. When  $C_4$  is set against the stop at maximum capacity,  $C_3$  tunes over the lower half of the 1.75 and 3.5-Mc. bands, and over all of the other bands. Then by turning the knob against the stop at minimum capacity, the high-frequency part of the broad bands may be covered. By this means the band spread is approximately doubled, with a corresponding increase in

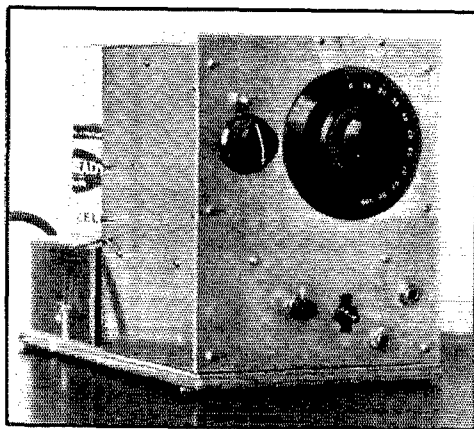

The simple freqmeter is built on a plywood base with aluminum shielding of the frequency-control unit. The knob on the front changes the range of the meter (see text) and the small screw above the knob permits initial setting of the tuning range.

One simple way to reduce the temperature effects in a frequency meter is to work everything near room temperature. The new dry-cell tubes allow this, and W7CQE describes a simple meter using the principle. Temperature compensation takes care of changes in room temperature.

accuracy in reading the tuning dial, and at the same time the meter can be quickly and accurately re-set.

The second movable element of  $C_4$  is a "correction" attachment, for bringing the meter back to a previous calibration and thus compensating for slight changes which may occur over a period of time. It consists of a small plate (about  $\frac{1}{2}$  inch square) soldered to one of the stator terminals of  $C_4$ . The end of a long screw passing through a hole tapped in the panel approaches this plate. Another small plate has a hole tapped at its center and is screwed on the end of the long screw with a lock nut behind it, to form the other plate of the condenser. A milled nut on the projecting part of the screw provides a means for locking the screw firmly in any desired position.

$C_2$  is a single bearing condenser, with ceramic insulation, mounted in the upper compartment by means of a bracket or angle fastened to the panel with its shaft vertical and with a slot cut in the end of the shaft so that it may be set by a screw-driver.

The oscillator section of the meter is mounted in an aluminum cabinet. The front panel of this cabinet is 7 inches by  $8\frac{1}{2}$  inches high, and the bottom, 6 inches by  $6\frac{3}{4}$  inches wide, is raised  $2\frac{1}{2}$  inches from the bottom of the panel. The 56 tube and its associated parts are mounted on and under a base formed from a sheet of aluminum  $4\frac{1}{2}$  inches by 12 inches, with ends bent down to form  $2\frac{3}{4}$ -inch deep sides and top  $4\frac{1}{2}$  inches by  $6\frac{1}{2}$  inches. A  $2\frac{3}{4}$ -inch circular hole in this accommodates the dry cell. This base is located

just back of the cabinet but separate from it to avoid heat transmission from the 56, both base and cabinet being fastened to a 7-inch by 11-inch plywood base. The cabinet rests on this base at only three points, to avoid possible distortion effects.

The dial is a 4-inch National Type A with a home-made vernier. No doubt a dial of the precision type would be better, but this one had been in use on another meter, and with a little care it can be read to  $\frac{1}{10}$  of a division or closer which, with the spread available, is accurate enough.

Switching arrangements are not shown in the diagram. The receiver output and B supply are brought into the freqmeter-monitor and, in transmitting, a three-pole double-throw switch switches from receiver to monitor, at the same time cutting the oscillator filament and receiver "B" in and out.

The meter is quite insensitive to voltage variations. At 7 Mc. a drop in oscillator filament voltage from 1.50 to 1.25 volts produced no perceptible change in frequency; a drop to 1.15 volts produced a change of about 400 cycles. Dropping the B supply voltage from 265 to 210 volts produced no perceptible change.

From experience so far with this meter, I believe that, with occasional checks from a frequency standard or from a broadcast station, it can be relied on within  $\frac{1}{2}$  kc. at 7 Mc., or to within about one part in 15,000. This may be much closer than is really necessary unless one is working very close to the edges, but the ability to measure frequencies to this degree of accuracy is a source of considerable satisfaction at all times and is very much worth while.

## Strays

The type 1624 beam-power tube recently announced by RCA should be of unusual interest to those contemplating emergency or portable equipment. In characteristics, it is identical to the type 807 used so widely in portable gear, but has a 2.5-volt 2-ampere fast-heating filament which permits quick on-off operation with the possibility of a saving in filament-battery life.

Fig. 1 — Wiring diagram of the simple freqmeter-monitor.

- $C_1$  — 50- $\mu$ fd. ceramic, -0.0003 coefficient (Centralab)
- See text for adjustment data.
- $C_2$  — 140- $\mu$ fd. variable condenser.
- $C_3, C_4$  — 35- $\mu$ fd. variable. See text on  $C_4$ .
- $C_5$  — 250- $\mu$ fd. midget mica.
- $C_6$  — 0.006- $\mu$ fd. mica.
- $C_7$  — 0.01- $\mu$ fd. paper.
- $C_8$  — 50- $\mu$ fd. mica.
- $C_9$  — 0.5- $\mu$ fd. paper.
- $C_{10}$  — 1.0- $\mu$ fd. paper.
- $R_1, R_7$  — 100,000 ohms,  $\frac{1}{2}$ -watt.
- $R_2$  — 15,000 ohms, 1-watt.
- $R_3$  — 10,000 ohms, 1-watt.
- $R_4$  — 25,000 ohms, 2-watt.
- $R_5, R_8$  — 50,000 ohms,  $\frac{1}{2}$ -watt.
- $R_6$  — 0.5 megohm,  $\frac{1}{2}$ -watt.
- $L_1, L_2$  — See text.

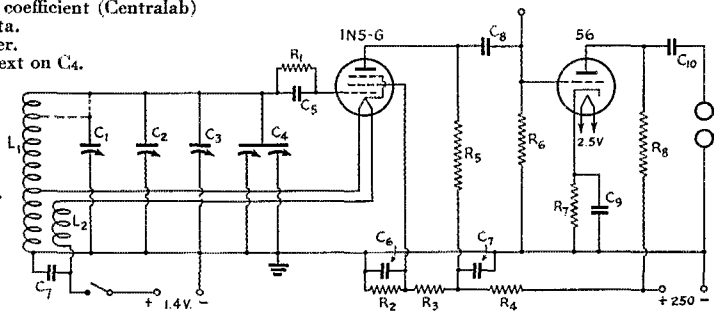

# ★ WHAT THE LEAGUE IS DOING ★

## 7-MC. POLL

IT WILL be remembered that in July, at the instance of the A.R.R.L. Board, we took a poll of amateur sentiment on the question of whether the League should endeavor to get 7200-7300 kc. opened to 'phone work in the event this step was found necessary to enable us to combat foreign broadcast interference. About 82% of the replies favored such a course:

	Yes		No	
U.S.A. and Possessions	6387	81.9%	1416	18.1%
Canada	372	84.4%	69	15.6%
	6759	82.0%	1485	18.0%

As we explained in July *QST*, the Board of Directors then proceeded to study these expressions in the light of the actual interference found to exist since September 1st. It was of course just then that Europe's difficulties began. Whether the war has slowed up the occupancy of these frequencies for broadcasting abroad we don't know; it seems likely. But at any rate, as every amateur knows, the actual interference situation has not been particularly bad. It may become so later in the winter, in which event the subject will be studied anew. But for the present the A.R.R.L. Board has decided it requires no action.

## WASHINGTON NOTES

THE minor changes in our regs mentioned last month, including authority for carrier-on operation above 112 Mc., are still pending before F.C.C. . . . Nobody sees how the Stockholm C.C.J.R. meeting can be held and its postponement is expected. However, the inter-American regional conference at Santiago, Chile, in January is still on the docket and preparatory work has begun. The League will be represented there by General Counsel Segal and Secretary Warner. . . . Recent interference statistics show numerous b.c.l. QRМ complaints caused by 28- and 56-Mc. operation. As much of the work in these bands is done by portable stations which do not have to report their whereabouts, the stations at fault are often hard to locate. The F.C.C. is contemplating extending to 60 Mc. the requirement to report in advance the locations where portable (but not mobile) work will occur.

## MEMBERSHIP CONTACT

WITH the return of the active hamming season the officers of the League and Headquarters staff members have been getting around the country extensively, meeting with and speaking before our affiliated clubs and other member-

ship gatherings. President Woodruff attended meetings in Montana and Washington and was the guest of honor at the Roanoke, Rocky Mountain and Northwestern Division conventions. Vice-President Bailey also attended the Roanoke Convention and, together with Secretary Warner, represented the League at the Hudson Division Convention. Communications Manager Handy found time from the rush of Fall activity to be present at the Vermont State Convention and the New Hampshire Hamfest.

Most of the League's travel, of course, is to affiliated clubs, and the early Fall has seen a great deal of this type of contact. Assistant Secretary Budlong has just finished an 11,000-mile trip to the Coast and back, during which he attended meetings with fifteen affiliated clubs, visited League members in six additional cities and was present at the Rocky Mountain, Northwestern, the combined Pacific-Southwestern and West Gulf Division conventions; Assistant Secretary Huntoon completed a two-weeks' trip through Eastern States for a total of nine club sessions, a hamfest, and the Central Division and Wisconsin State conventions; and Assistant Communications Manager Battey is now on a jaunt through the Midwest, which will take him to affiliated-club meetings in fourteen cities and to the Midwest Division and Kansas State conventions.

It's a busy season!

## WWV Schedules

EXCEPT for the special broadcasts of WWV using 20 kw. as described below, WWV is now running a continuous schedule (day and night) on 5000 kc. with a power output of 1 kw. This continuous transmission is modulated with the standard pitch in music, 440 cycles per second.

Each Tuesday, Wednesday and Friday (except legal holidays), the National Bureau of Standards station, WWV, transmits with a power of 20 kw. on three carrier frequencies as follows: 10:30 to 11:30 A.M., E.S.T., on 5000 kc.; noon to 1:30 P.M., E.S.T., on 10,000 kc.; 2:00 to 3:30 P.M., E.S.T., on 20,000 kc. The Tuesday and Friday transmissions are unmodulated c.w. except for 1-second standard-time intervals consisting of short pulses with 1000-cycle modulation. On the Wednesday transmissions, the carrier is modulated 30% with a standard audio frequency of 1000 c.p.s. The accuracy of the frequencies of the WWV transmissions is better than 1 part in 5,000,000.



# Cathode Modulation

◆

A complete 'phone transmitter, including power supply and modulator, capable of delivering a 100%-modulated carrier of 60 watts. The two 6F6 tubes used to modulate the push-pull T20 amplifier can just be seen in back of the tank condenser. The crystal socket is just to the left of the 6V6 oscillator.

◆

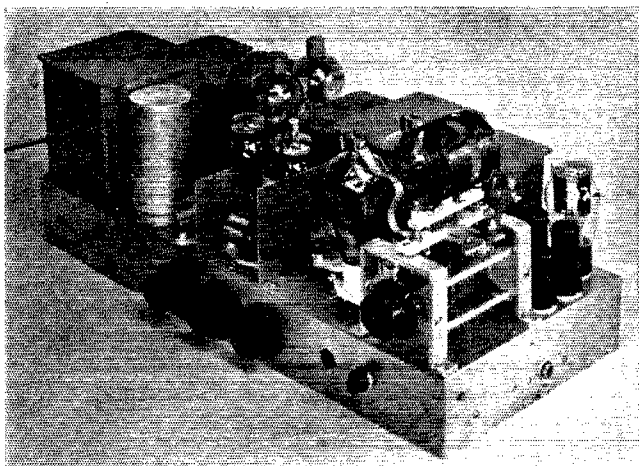

## *Combining Grid and Plate Modulation for Economy and Efficiency*

BY FRANK C. JONES, W6AJF\* AND FRANK W. EDMONDS, W2DIY\*\*

**C**ATHODE modulation is a system of modulation which brings the advantages of high-power 'phone operation to a much greater group of amateur operators than has heretofore been possible. By means of this system of modulation it is possible to modulate a high-power Class C amplifier with a surprisingly small amount of audio power, thus appreciably decreasing the size and cost of the modulation equipment.

This system of modulation, as the name implies, impresses the audio signal on the cathode circuit of the Class C stage, as shown in Fig. 1. Since the cathode circuit is common to both the grid and plate circuits of the Class C stage, cathode modulation is thus a combination of plate and grid modulation.

The audio power required for 100% cathode modulation is greater than that required for grid modulation, but considerably less than that needed for plate modulation. Cathode modulation is not attended by the difficulties of adjustment inherent in grid-modulated equipment, nor does it require the abundance of Class C r.f. grid drive necessary for plate modulation.

Whereas a plate-modulated Class C amplifier requires audio power equal to 50% of the Class C d.c. input power, the amount of audio power required for cathode modulation is between 5 and 15% of the d.c. input power, depending on the amplification factor of the Class C tube and on the degree of impedance mismatch between the modulator and cathode impedance. The impedance of the cathode circuit of the modulated stage will appear to be between 300 and 2000

ohms, depending on the characteristics of the tube or tubes. An impedance mismatch of 4 or 6 to 1 has little effect on the character of the modulation but will require the use of slightly more audio power, depending on the degree of mismatch. An average value of 500 ohms will be found satisfactory in most cases, and transformers designed to work into a 500-ohm load may be used for cathode modulation provided that the 500-ohm winding is sufficiently heavy to carry the Class C plate and grid current, and the size of the transformer is sufficient to permit dissipation of the additional heat due to the added  $I_2R$  losses involved. Transformers which are designed to permit a closer match of cathode impedance will, of course, result in greater modulation efficiency and hence less audio power will be required.

The mechanics of cathode modulation are as follows: The instantaneous negative peak voltage impressed on the cathode increases the instantaneous plate voltage, and at the same time decreases the grid bias, both of which factors cause

Any modulation system that requires only about one-fifth the audio power required for plate modulation and still allows the final amplifier to realize between 50 and 60% efficiency would seem to be destined for widespread application. It now appears that cathode modulation—known years ago as "center-tap modulation"—has been hiding its light under a bushel, since it is just such a system. Here's your chance to get acquainted.

\* 2037 Durant Avenue, Berkeley, Calif.

\*\* Instant Transformer Corp., 150 Varick St., New York City.

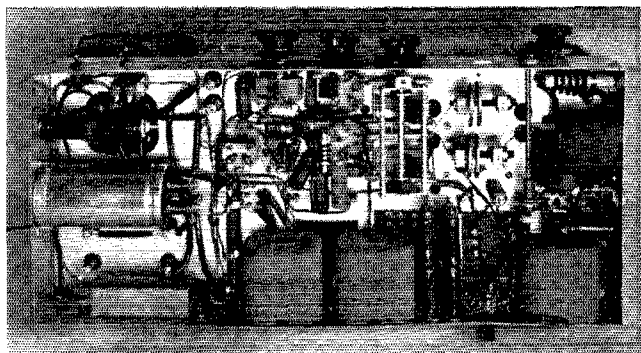

A view underneath the chassis shows how compact the modulator unit of a cathode-modulated transmitter can be. The entire modulator unit requires only the two small transformers shown at the extreme right.

an increase in r.f. output. Similarly, an instantaneous positive voltage will cause a decrease in r.f. output due to a decrease in plate voltage and an increase of bias. Thus the grid and plate modulation is in phase and capable of 100% modulation.

The ratio of grid and plate modulation determines the efficiency at which the Class C stage may be operated. A Class B amplifier which is 100% grid-modulated usually runs at 30 to 35 per cent efficiency with no modulation. A cathode-modulated Class C amplifier can be adjusted to run at 60% efficiency. If the grid modulation is reduced to 70 to 75% of the total, the amplifier may then be adjusted to run at a resting efficiency of 50 to 60%, with resultant higher carrier output. The remaining 25% modulation may then be obtained in the form of plate modulation of the cathode circuit. The 25% plate modulation can be obtained with an audio power of approximately 4% of the d.c. plate input under ideal conditions. The power required for grid modulation of 60 to 70% is approximately equal to 1 to 2% of the d.c. plate input. Therefore, under average conditions, an audio power equal to 10% of the d.c. plate input will be sufficient for 100% cathode modulation.

Low- $\mu$  triodes should be used in the cathode-modulated Class C amplifier, since they are somewhat more suitable for grid modulation. Pentodes or tetrodes are not suitable because of their extremely high amplification factor, although triodes with a  $\mu$  of 20 to 30 may be used with a slight sacrifice of carrier power. Bias may be obtained by means of a grid resistor, although a source of fixed bias voltage is preferable and will give better grid voltage regulation. The bias should be several times cut-off and, if obtained by a grid-leak resistor, the resistance should be several times greater than that used for c.w. or plate-modulated amplifiers. The grid-leak resistance should be bypassed for audio frequencies by a  $\frac{1}{2}$ - to 1- $\mu$ d. paper condenser. If too much grid modulation is obtained, part of the grid resistance should be left without by-pass to limit the degree of grid modulation. It is advisable to

use a variable grid resistance or variable-voltage bias pack in order to compensate for the varying r.f. drive and antenna loading on different bands, if the transmitter is to be used on more than one band. This is easily accomplished by using a number of resistors in conjunction with a rotary tap switch to cut in the required amount of grid resistance. In adjusting the bias resistance, the resistance should be increased until the monitoring 'scope shows full modulation is being obtained. If the resistance is too low, the carrier will not be fully modulated; if it is too high, over-modulation will result.

Too much r.f. drive will decrease the percentage of modulation obtainable, but will not seriously affect the quality. Too little drive will reduce the available carrier and result in over-modulation. The antenna loading should be rather heavy, as is the case with a Class B linear amplifier. Too light loading will result in downward modulation. The Class C stage should be loaded to the point where a further increase in loading causes a decrease in antenna current, for proper operation.

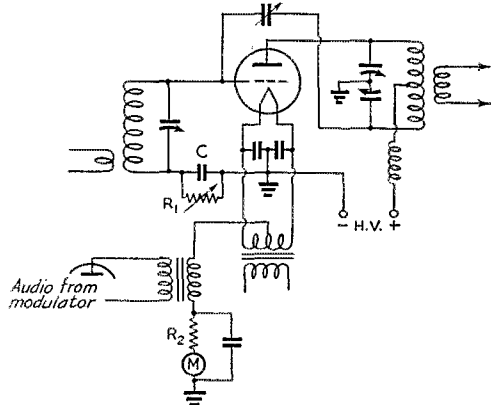

Fig. 1—The fundamental cathode-modulation circuit. Audio from the modulator unit is introduced in the cathode (center-tap) circuit of the tube or tubes being modulated. The grid-leak resistance  $R_1$  is adjusted for proper modulation characteristics, and  $R_2$  serves to give some original bias to the tube. Condenser  $C$  must be large enough to by-pass the modulation frequencies.

When the transmitter is properly adjusted, the cathode current will remain very nearly constant under modulation. Some slight change (5%) is not serious, however.

### A 100-Watt Transmitter

A representative transmitter, employing cathode modulation, is shown in the photographs. This 100-watt transmitter is indicative of the space economy which may be obtained with a cathode-modulated transmitter. It is mounted on a standard 10" x 23" x 3" chassis which contains the three r.f. stages, two power supplies, and the speech amplifier and modulator.

The r.f. line-up is a 6V6 regenerative crystal oscillator, an 807 buffer, and a push-pull T20 power amplifier. In the audio, a 6SJ7 pentode feeds a 6C5 which is transformer-coupled to the p.p. 6F6 modulators. The modulation transformer is one which has been designed to match several impedances between 300 and 2000 ohms for proper matching to the cathode circuit of the Class C amplifier. The low-voltage supply furnishes power to the speech amplifier and to the oscillator and buffer. The Class C plate power is supplied from the high-voltage power supply at the left-hand end of the chassis. The 6SJ7 was

(Continued on page 102)

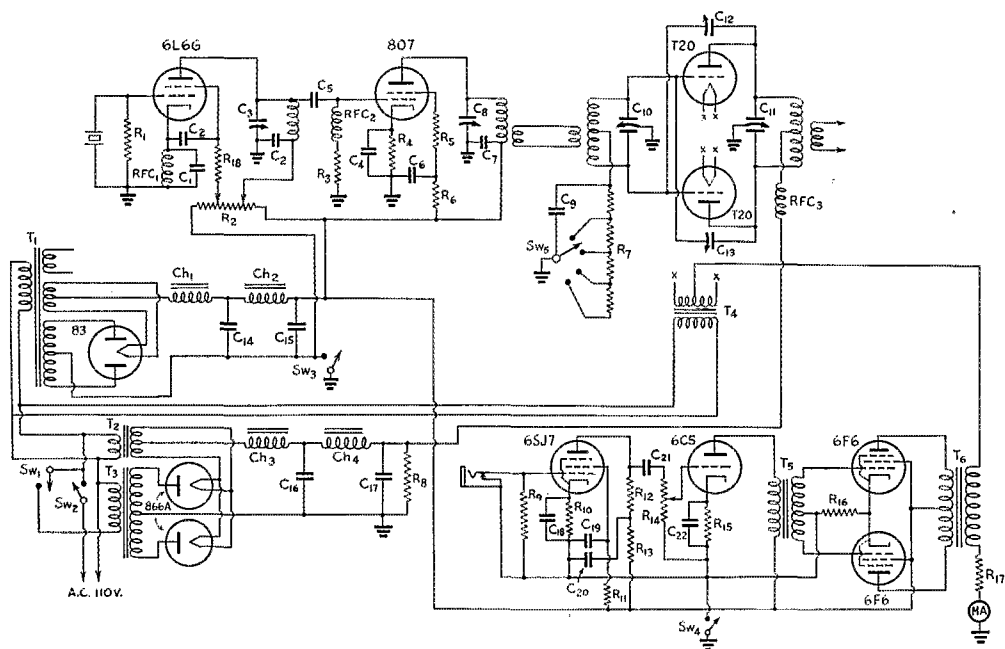

Fig. 2 — Diagram of the 100-watt cathode-modulated transmitter.

- |                                                                           |                                                       |                                                           |
|---------------------------------------------------------------------------|-------------------------------------------------------|-----------------------------------------------------------|
| C <sub>1</sub> — 500- $\mu$ fd. mica.                                     | Ch <sub>4</sub> — 20-henry, 225-ma. filter            | RFC <sub>1</sub> , RFC <sub>2</sub> — 2.5 mh. r.f. choke, |
| C <sub>2</sub> , C <sub>7</sub> — 0.01- $\mu$ d. mica.                    | choke (S-31).                                         | 125 ma.                                                   |
| C <sub>3</sub> , C <sub>8</sub> — 100- $\mu$ fd. variable.                | R <sub>1</sub> — 50,000-ohm, 1-watt.                  | RFC <sub>3</sub> — 2.5 mh. r.f. choke, 500 ma.            |
| C <sub>4</sub> , C <sub>6</sub> , C <sub>21</sub> — 0.01- $\mu$ d. paper. | R <sub>2</sub> — 25,000-ohm, 50-watt.                 | SW <sub>1</sub> — S.p.s.t. toggle.                        |
| C <sub>5</sub> — 50- $\mu$ fd. mica.                                      | R <sub>3</sub> — 15,000-ohm, 2-watt.                  | SW <sub>2</sub> , SW <sub>3</sub> — D.p.s.t. toggle.      |
| C <sub>9</sub> — 1.0- $\mu$ d. paper.                                     | R <sub>4</sub> — 100-ohm, 10-watt.                    | SW <sub>4</sub> — On volume control.                      |
| C <sub>10</sub> , C <sub>11</sub> — Split-stator, 100 $\mu$ fd.           | R <sub>5</sub> — 100-ohm, 1-watt.                     | SW <sub>5</sub> — 11-position rotary switch.              |
| each section, variable.                                                   | R <sub>6</sub> — 20,000-ohm, 20-watt.                 | T <sub>1</sub> — Plate-filament transformer;              |
| C <sub>12</sub> , C <sub>13</sub> — 10- $\mu$ fd. neutralizing            | R <sub>7</sub> — 16,000-ohm, 20-watt, tapped          | 525 volts at 250 ma. (S-39).                              |
| condenser.                                                                | every 2000 ohms (made                                 | T <sub>2</sub> — Filament transformer, 2½-                |
| C <sub>14</sub> , C <sub>15</sub> — 8- $\mu$ fd., 450-volt elec-          | from eight 2000-ohm res-                              | volt, 10-ampere (S-57).                                   |
| trolytic.                                                                 | istors).                                              | T <sub>3</sub> — Plate transformer, 990-volt,             |
| C <sub>16</sub> , C <sub>17</sub> — 2- $\mu$ fd., 1000-volt.              | R <sub>8</sub> — 50,000-ohm, 100-watt.                | 200-ma. (S-45).                                           |
| C <sub>18</sub> , C <sub>22</sub> — 10- $\mu$ fd., 25-volt elec-          | R <sub>9</sub> , R <sub>11</sub> — 2-megohm, ½-watt.  | T <sub>4</sub> — 7.5-volt filament transformer,           |
| trolytic.                                                                 | R <sub>10</sub> — 2500-ohm, ½-watt.                   | 8-ampere (S-61).                                          |
| C <sub>19</sub> — 0.25- $\mu$ fd., 400-volt paper.                        | R <sub>12</sub> — 0.25-megohm, ½-watt.                | T <sub>5</sub> — Interstage audio transformer,            |
| C <sub>20</sub> — 0.5- $\mu$ fd., 400-volt paper.                         | R <sub>13</sub> — 100,000-ohm, ½-watt.                | plate to p.p. grids (S-30).                               |
| Ch <sub>1</sub> — 5-25-henry swinging choke,                              | R <sub>14</sub> — 1-megohm volume control,            | T <sub>6</sub> — Cathode modulation trans-                |
| 175 ma. (S-30).                                                           | with switch.                                          | former, 6F6 plates to 300-                                |
| Ch <sub>2</sub> — 10-henry, 175-ma. filter                                | R <sub>15</sub> — 2,000-ohm, ½-watt.                  | 2000-ohm load (CM-15).                                    |
| choke (S-29).                                                             | R <sub>16</sub> , R <sub>17</sub> — 200-ohm, 20-watt. | Figures in parentheses refer to                           |
| Ch <sub>3</sub> — 5-25-henry swinging choke,                              | R <sub>18</sub> — 10,000-ohm, 1-watt.                 | UTC type number.                                          |

# The U.H.F. Relay!

**Eastern Messages Reach Chicago—W1HDQ-W3DBC Messages Fastest—A Second U.H.F. Contest To Be Held November 4th-5th**

BY F. E. HANDY,\* WIBDI

TO THE 56-Mc. adventurers who stuck by their transmitters through thick and thin goes the credit for the success of Number One Relay-and-Field-Day for the u.h.f. bands! A "box" announcement credits the scores, or individual standings of the fellows who pushed the messages

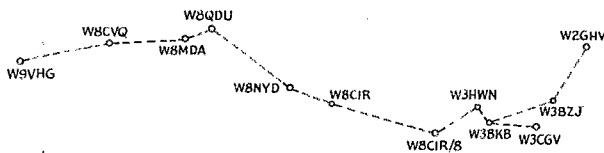

The Best Relay Route. East coast points to Chicago — 1000 miles via 56 Mc.!

and who reported the most outstanding number of contacts. Poor conditions were reported from some points, but that was the idea, to prove to the doubters that real communication *can* be accomplished on u.h.f. day in and day out, with average conditions — no exceptional lucky breaks required. It can.

Dozens of messages were flying about. If there were any disappointed hams, they were the ones that didn't try to handle any. Credit is due many unreported fellows at isolated points, who like W5FYF-W4GAW-W4ELZ, etc., got on in Georgia, and Oklahoma, and far flung states. Every district has now been covered by 5 meters. W9ZJB has even "worked all districts" as reported in detail last month. Many isolated fellows conscientiously tried to hear the stations they knew were on for the Relay. Hour after hour these men were on the job, and with a few "filler-in" stations we would have had many additional successful routes to surprisingly diverse sections of the country. Each relay to come should see progress, new routes made, old records shattered.

In this relay the record message, for distance and number of relays, was one started from W2GHV, Dumont, N. J., just a few miles from N. Y. C., which got through to W9VHG, Glenview, Ill., covering over 1000 miles (710 miles airline) between 7:40 P.M. September 9th and 10:37 P.M. September 10th by the following route:

W2GHV-W3BZJ-W3BKB-W3HWN-W8CIR/S-W8NYD-W8QDU-W8MDA-W8CVQ-W9VHG

A close competitor, was a message started from

\* Communications Manager.

Wilmington, Delaware, which went 690 airline miles to the same destination, near Chicago:

W3CGV-W3BKB-W3HWN-W8CIR/S-W8CIR-W8NYD-W8QDU-W8MDA-W8CVQ-W9VHG

8:20 P.M. (9th) to 10:21 P.M. (10th) is good time for that many relays also, about two hours per hop, average. Both these messages were directed to "any west coast amateur." A chain of stations down through Indiana or So. Illinois and through Missouri, would

have put these messages to our Oklahoma friends who were alert for any such opportunity.

A distance of 325 airline miles, *with answer back*, is also something to be proud of, for 56-Mc. performance. It isn't done every day, though with all the gang on each weekend, it should be possible to keep things lined up by actually running such tests *each week*. For speed and efficiency we commend the following multi-hop relay to your attention: Addressed to Washington, D. C., this message actually went there, with answer returned! W1HDQ (Wilbraham, Mass.), W1LL (Hartford), W1IJ (Madison), W2JCR/1 (Fairfield Beach), W1KTF (Stamford), W3FQS (Stony Creek Mills, Pa.), W3CGV (Wilmington), W3DBC (Washington, D. C.). The message was filed at 3:10 P.M. at the start of the relay, got to destination at 9:45 P.M., and the reply by the following route got back at 11:32 P.M.:

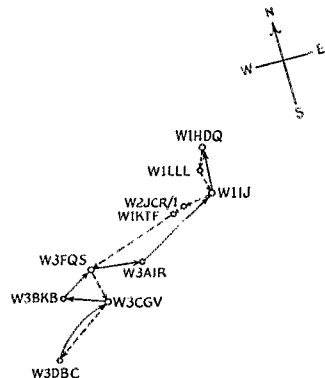

W1HDQ to Washington, D. C., and return route.

W3DBC-W3CGV-W3BKB-W3FQS-W3AIR-W1IJ-  
W1HDQ

(7 stns., 2 hrs., 24 mins.).

Other notable message routes:

One from W1JLI to W4DRZ, travelled W1JLI-W1HXP-W1KIK/1-W1HDQ-W1BDI-W1KLJ-W1IJ-W1CLH-W3AC/3-W3HOH-W3FQS-W3CGV-W3GGR-???

One from W1KIK/1 to "any Florida station," travelled W1KIK/1-W1HDQ-W1LL-L-W1IJ-W1CLH-W1KLJ-W3BZJ-W3CTV-W3GGR-???

One from W3FQS "to New Hampshire," travelled W3FQS-W3BZJ-W3AC/3-W1HDQ-W1AUN-W1KIK/1-W1KXX (New Market, N. H.) 4:25 P.M., 10th. An answer, giving the time received, returned all the way to W3FQS: W1KXX-W1KIK/1-W1HDQ-W1IJ-W1CLH-W3AC/3-W3HOH-W3FQS.

One travelled W3AIR-W3AC/3-W1AUN-W1KIK/1-W1DEI (destination) W1DEI's message to W3AIR got most of the way OK: W1DEI-W1KLJ-W1IJ-W3AC/3-W3HOH-W3FQS (on hook at end).

A message to Hartford came all the way on "5": W3NF/3-W3EUA-W3BYF-W3AC/3-W1KLJ-W1LL-L-W1INE.

### Bridging Gaps

As predicted, some stations set up at high points and mobiles at half-way places, were in a position to render invaluable assistance to the establishment of routes. The notable work of W1KIK/1, Mt. Wachusett; W1HDQ, Wilbraham Mountain, Mass.; W1KLJ, Fall Mt., Bristol, Conn.; W8CVQ, Kalamazoo, Mich.; W3BZJ, Glenside, Pa., of W3AC/3, High Point Park, N. J., and the stations in the upper half of the score tabulation is due to the earnest efforts of those operators in organizing relay routes plus



W3AC/3, leading station in the Relay operating from his Plymouth coupe at High Point Park, N. J. (alt. 1800 ft.).

their strategic locations in some cases. W8CIR's planning was most noteworthy, since it made the 1000 mile relay success possible.

W8CIR/8 went mobile from Aliquippa to Tuscarora Summit near McConnellsburg in the Southern Central part of Penna. This location was decided upon in an effort to bridge the gap existing in the mountains of Central Penna. W8CIR at Aliquippa, Pa., 20 mi. N.W. of Pgh., Pa. (the home location), was to relay messages to W8SFF in Colver, Pa., near Altoona, an 85-mi. hop thence from Colver to McConnellsburg to mobile W8CIR — 65 mi., and then eastward. W8EEO also went mobile to try and place himself between Colver and McConnellsburg to break the 65-mi. hop between these two points. W8CIR in Aliquippa had no difficulty in giving messages to W8SFF in Colver. However, mobile W8CIR, mobile W8EEO and W8SFF could not hear each other. Mobile W8CIR in McConbrg., however, succeeded in working W3HWN, Harrisburg, Pa., 65 mi., and W3BZJ, Glenside, Pa., 150 mi., and heard W3RL, Herndon, Va., and W3BKB, York, Pa. After three messages for the west were taken from W3HWN conditions became worse with wind and rain. After midnight we decided to pull up stakes and go home, arriving there at 5 A.M. Sunday. Three messages were relayed by "Pony Express" the 150 mi. back to the home station (W8BHY kept vigils there) and then relayed by radio further west!

Equally commendable work was done by many stations. W3BZJ, who sent us 25 message copies,

(Continued on page 96)

### SCORE STANDINGS<sup>1</sup> of Reporting Stations in the U.H.F. Relay and F.D.

W3AC/3.....	308	W3ETA/8.....	48
W1KIK/1.....	146	W3BYF.....	34
W3BZJ.....	135	W2IQQ/2.....	34
W1HDQ.....	118	W2KDV.....	31
W1KLJ.....	111	W1AUN.....	29
W1IJ.....	100	W2ILK.....	27
W3HOH.....	93	W9VHG.....	26
W8CVQ.....	78	W8CIR/8.....	20
W8QDU.....	77	W3EUA.....	19
W3FQS.....	74	W1BDI.....	19
W3CGV.....	64	W8QQS.....	14
W8MDA.....	59	W3FJI.....	13
W8CIR.....	55	W3GGR.....	10
W1CLH.....	52	W1DCH/1.....	8

<sup>1</sup> Each station worked counted 1, 2, 5 or 10 points for distances up to 50, 100, 300 miles and over, respectively. One test message origination counted 10 points with a point for receiving, and 2 points for relaying onward any test message. Stations in the field multiplied the sum of all points by two.

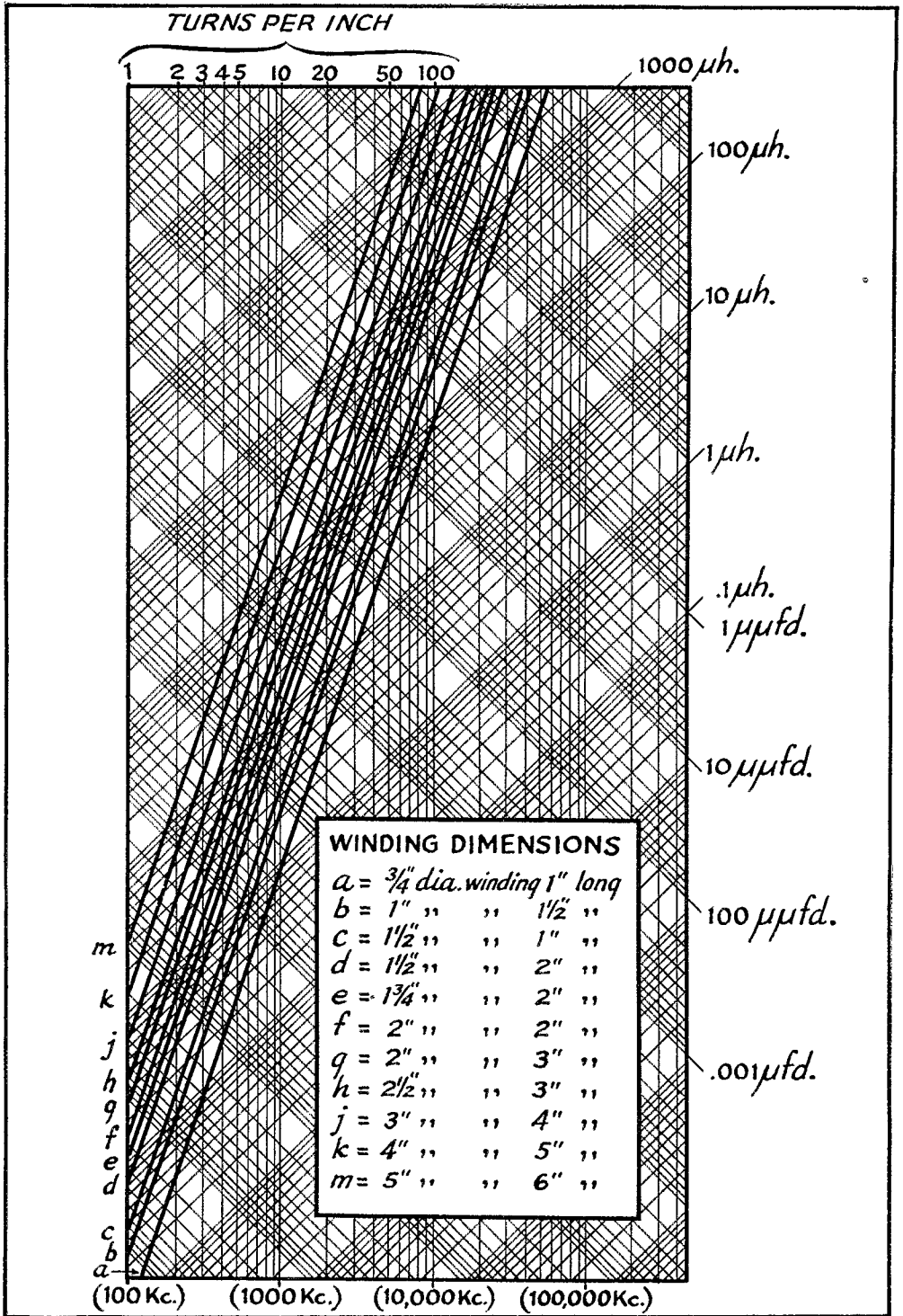

# Coil Chart for Quick Reference

BY L. C. GALLAGHER,\* W5FRE

WHEN new transmitter tank circuits or tuning circuits for receivers are needed, much pad scratching and searching for formulas may be saved by reference to the handy chart shown on the opposite page. In this chart, the 45-degree diagonal lines — inductance and capacity — may be used with the vertical frequency lines to find the amount of inductance needed for tuning over a required range of frequencies with the capacity available. Once the inductance has been determined, the diagonal line corresponding to this value may be followed through its intersections with the lines for coil dimensions. The result of this step is found in the scale of turns per inch at the top of the chart.

As an example of the use of this chart, suppose that a tuned circuit for the 3.5-megacycle band is needed in the output of an r.f. amplifier using single-section condenser and center-tap grounded coil, and operating with 1250 volts at 100 ma. plate current. Reference to a table of capacity values for use with different plate voltage-current ratios<sup>1</sup> gives a requirement of 80 micro-microfarads capacity for 3.5 megacycles under these conditions.

With the capacity value now determined, the chart on the opposite page is used to find the amount of inductance required for resonance. By following the 3500-kc. vertical line upward (actually, no line is shown at this exact frequency, but an imaginary line between the 3- and 4-megacycle lines is used), the point where it crosses the 80-micro-microfarad capacity diagonal is found. The inductance line passing through this point at a right angle to the capacity line indicates a value of approximately 25 microhenries needed for resonance. Suppose a coil of 2-inch diameter and 2-inch winding length is to be used. Following the 25-microhenry inductance line downward, a point is found where it crosses the line "f" (found in the table at lower right corner of chart to be the line for 2-inch coil). The vertical line to the top of the chart from this point gives a turns-per-inch figure of 13 for the 25-microhenry coil, or a total number of 26 turns for the 2-inch winding length. The line for a coil of 3-inch diameter and 4-inch winding length gives a point on the 25-microhenry line from which 6 turns per inch, or 24 turns total, are found to be required.

Other uses of the chart include determination of required capacity for tuning through a selected frequency range when a coil for the purpose is already available.

\*1508 So. Travis St., Sherman, Texas.

<sup>1</sup>Fig. 825, *Radio Amateur's Handbook*, 1939 edition.

## New Transmitting Tube

THE 828 is a beam power tube designed particularly for Class-AB<sub>1</sub> modulator and a.f. power-amplifier service, but is also useful as an r.f. power amplifier, frequency multiplier, oscillator and grid- or plate-modulated amplifier. Two 828's in Class AB<sub>1</sub> service are capable of delivering 300 watts of audio power with only one percent distortion. Maximum plate dissipation of the 828 for this service is 80 watts. Because of its high power sensitivity, the 828 can be operated in r.f. services to give full power output with very little driving power and, consequently, with a minimum number of driver stages.

Ratings and typical operating conditions are as follows:

Filament voltage (a.c. or d.c.)	10
Filament current	3.25 amps.
Transconductance, for plate current of 43 ma.	4500 $\mu$ mhos
Interelectrode capacities:	
Grid-plate (with external shield)	0.05 $\mu$ fd.
Input	13.5 $\mu$ fd.
Output	14.5 $\mu$ fd.

### Push-pull Class-AB<sub>1</sub> Modulator

#### Typical Operation

D.c. plate voltage	1700	2000
D.c. suppressor voltage	60	60
D.c. screen voltage	750	750
D.c. grid voltage	-120	-120
Peak a.f. grid-to-grid voltage	240	240
Zero-sig. d.c. plate current	50 ma.	50 ma.
Max. sig. d.c. plate current	248 ma.	270 ma.
D.c. suppressor current	9 ma.	9 ma.
Zero-sig. screen current	4 ma.	2 ma.
Max.-sig. screen current	43 ma.	60 ma.
Plate to plate load resistance	16,200	18,500 ohms
Max. sig. power output	300	385 watts

### Plate-Modulated Class-C Telephony

#### Typical Operation

D.c. plate voltage	1000	1250
D.c. suppressor voltage	75	75
D.c. screen voltage	400	400
Screen resistor	26,000	30,000 ohms
D.c. grid voltage	-140	-140
Grid leak resistor	14,000	11,700 ohms
Peak r.f. grid voltage	230	250
D.c. plate current	135 ma.	160 ma.
D.c. suppressor current	13 ma.	15 ma.
D.c. screen current	23 ma.	28 ma.
D.c. grid current approx.	10 ma.	12 ma.
Driving power approx.	2.1	2.7 watts
Power output approx.	100	150 watts

### Class-C Telegraphy

#### Typical Operation

D.c. plate voltage	1250	1500
D.c. suppressor voltage	75	75
D.c. screen voltage	400	400
D.c. grid voltage:		
From a fixed supply	-95	-100 volts
From a grid resistor	7900	8300 ohms
From a cathode resistor of	415	430 ohms
Peak r.f. grid voltage	195	205
D.c. plate current	160 ma.	180 ma.
D.c. suppressor current	22 ma.	14 ma.
D.c. screen current	35 ma.	28 ma.
D.c. grid current approx.	12 ma.	12 ma.
Driving power approx.	2.1	2.2 watts
Power output approx.	150	200 watts



## NAVAL COMMUNICATION RESERVE NOTES

### NCR SIXTH NAVAL DISTRICT

**T**HE Naval Communication Reserve of the Sixth Naval District comprises units in Georgia, South Carolina, and North Carolina. Each of these states is represented by a section of the district organization and each state section in turn is made up of the several units of the Naval Communication Reserve in the respective state. The three sections are coordinated under the command of the Naval Communication Reserve, Sixth District Commander in Charlotte, N. C., and here the staff of the Naval Communication Reserve Commander is also located for the administration of the organization of the Sixth District.

All activities are directed from the staff headquarters at the Municipal Armory in Charlotte, and the only dependence placed upon the headquarters of the Sixth Naval District at the Navy Yard, Charleston, S. C., for actual Navy guidance is for instruction supervision and the requisitioning of material. Through such a system of administration, the Commander and his staff, along with the Section Commanders and their assistants, derive great benefit in practical training in administration. All drill schedules, training programs, courses of instruction, and material instruction are instituted by the staff headquarters in Charlotte. Through coordination with the Headquarters, Sixth Naval District, a progressive schedule of training is carried out annually so that at the end of each competitive year there are added a number of well trained operators ready to handle a regular Navy watch if the demands of mobilization should so require.

The Naval Communication Reserve of the Sixth District is fortunate to have as its Commander one of the pioneers in the radio game in the South. W4CQ has been battling with and for the hams in this area for so many years that the Naval Communication Reserve can feel that they are under divine guidance with the original "CQ-er" of this part of the country at their head. Another old-timer who is a regular caller on the ham bands and is still so enthused with the Navy as to give up many a night for the administration of the units in North Carolina is W4BRT. Across the state line to the south is W4CE, another Section Commander who works for another Federal Government agency during the daytime and then spends his evenings in administering to the needs of the Naval Communication Reserve in South Carolina. No less a personage than the Federal Inspector himself looks out for the newest unit in Savannah. Over 30% of the members of

the organization in this district have ham tickets, and the elementary instruction given in the various units has resulted in an increasing number of applications for amateur licenses.

A cursory glance at a call book will show a noticeable scarcity of hams in the Carolinas and Georgia. The recruiting problem, therefore, to fill the Reserve ranks with licensed amateurs has been a difficult one for the past several years. During 1938-39, however, this enlistment situation has been ameliorated by recruiting a number of young men who have utilized the instruction periods during regular Naval Communication Reserve weekly drills as a means toward qualifying for a ham ticket. At the same time such training for Navy operating has progressed from the fundamentals of Navy procedure on up to the point where the men are well qualified as watch standers by the time they obtain their amateur "tickets."

During the past year the Naval Communication Reserve of the Sixth District demonstrated its efficiency in time of local emergencies when a tornado hop-skipped in and about the city of Charleston in September. In addition to demolishing many historic buildings and leaving a heavy death toll in its wake, the "twister" made a complete job of putting down all telegraph and telephone lines connecting Charleston to the outside world. With all local power off for about 12 hours, and not available in some parts of the city for almost a week, Unit Five of Section One in Charleston was on the air to attend the regular Naval Communication Reserve drill ten hours after the tornado struck the city. Prior to checking in on the drill W4DFC had already been on the air for a couple of hours handling distress traffic, and after the drill his rig handled a good-sized load of personal distress messages until the wee small hours of the morning when the telephone and telegraph lines were partially restored. The emergency demonstrated the alertness of the Naval Communication Reserve to function under adverse conditions, and gave ample evidence of the new initiative spirit which promises to put the Naval Communication Reserve of the Sixth District up at the head of the other districts during the competition.

**SWITCH  
TO SAFETY!**





# Don't Miss the Tenth A.R.R.L. Sweepstakes

**Nov. 11th-12th, 18th-19th—Awards to Section<sup>1</sup> Leaders—Also C.W. and 'Phone Certificate in Each Club—Gavel to Winning Club—Use 'Phone or C.W. Any Ham Band(s)**

**F. E. HANDY\* W1BDI**

You can work more than 20 hours on one of the two 33-hour week-ends, but in no case will any entry more than 40 hours' total operating in the two contest periods be accepted. Use any amateur frequency bands you choose. This timing plan permits the average ham to plan for his time for meals, for 8 hours' daily sleep, etc. Cross examination of logs makes it possible to check operating time. Every amateur active in any A.R.R.L. field organization<sup>2</sup> section is cordially invited to take part.

Contest exchanges can be logged directly on the sheet that you send Hq. for a report. Paper work is completed as you go along with nothing to do but total and summarize points and send it in. *Mimeographed contest forms will be sent gratis to anyone who sends a radiogram or drops a card for the same.* Use of our sheets is not required nor is advance entry necessary. The purpose is to help participants keep a uniform log. Follow the arrangement or form shown with this announcement. Draw your own columns on your own paper if you like . . . or ask us for a form.

In the annual "SS" telegraphing operators will contact and compete with other telegraphing operators. 'Phone hams will compete with other 'phone hams.

Many complete their QSL-card records and achieve "WAS" through each year's "SS." This is the best chance of the year to progress toward that objective.

The contest is to work as many stations as possible. The points from such work will be multiplied by the number of *different* A.R.R.L. Sections<sup>2</sup> worked with at least a complete one-way exchange in the contest. All essential contest information is sent in the form of a standard preamble. Exchanges are for the record sent to Hq. New hams may also add to their knowledge of the way preambles to A.R.R.L. messages are sent and acknowledged, and fills requested, accuracy of 'phone communication assured, etc., if they take part and follow the standard practices set forth for these things in *The Radio Amateur's Handbook*. Some emergencies of late years have found amateurs unfamiliar with good operating practices, resulting in delays, garbles, and in-

\* Communications Manager, A.R.R.L.

<sup>1</sup> Including Cuba, Porto Rico, Hawaii, Alaska, P. I., etc.

<sup>2</sup> See the complete list of the 71 Sections in the A.R.R.L. field organization, page 6 of this issue of *QST*.

ability to write or take a message in standard form. The "SS" builds operating keenness at the same time new station records are made. It's operating fun.

The new award for winners this year is a beauty. In addition to its utility (a chromium pin and tie holder) a neat, diamond-shaped charm is attached. On this diamond will be inscribed the personal and individual call designation of each winner. The c.w. winner, and the radiotelephone winner, for each A.R.R.L. Section will receive recognition through this award (see page 10).

## The General Call

"CQ SS CQ SS CQ SS de W . . . W . . . W . . ." is used by stations looking for contacts in the Sweepstakes. A single, snappy CQ SS will bring results!

## THE CONTEST PERIOD

Time	Starts	Ends
A.S.T.	Nov. 11 & 18, 7:00 P.M.	Nov. 13 & 20, 4:01 A.M.
E.S.T.	Nov. 11 & 18, 8:00 P.M.	Nov. 13 & 20, 3:01 A.M.
C.S.T.	Nov. 11 & 18, 5:00 P.M.	Nov. 13 & 20, 2:01 A.M.
M.S.T.	Nov. 11 & 18, 4:00 P.M.	Nov. 13 & 20, 1:01 A.M.
P.S.T.	Nov. 11 & 18, 3:00 P.M.	Nov. 13 & 20, 12:01 A.M.

## Proof or QSO

At least one way complete six part exchange must be completed and acknowledged between two stations as "proof of QSO"<sup>3</sup> before points or Sections can be claimed.

It is not essential that each station worked be taking part in the contest to make your points count. Any operator who needs information can be referred to this announcement. First, ask the operator to take your preamble and come through with like information in preamble form.

## Power Factor and Scores

If the power input to the final stage (plate current times plate voltage —  $E \times I$ ) is:

<sup>3</sup> There is no point in working the same station more than once in the contest period if two points have been earned by an exchange. If but one point is made the first time, you can add a point by working this station again for exchange in the opposite direction. Underline all such exchange entries in your "list," identify them by showing parenthetically the call of the correspondence station. Leave right or left report columns blank so that other pairs of exchanges completed in one contact are side by side.

(a) Up to and including 100 watts — multiply score by 1.25.

(b) Over 100 watts — multiply score by 1.

Operating in both low- and high-power classes at different times is still permitted, but scoring rules do not permit Sections worked on high power to be used in the low-power classification. Points of some kind are credited for every QSO with a *bona fide* exchange, whether the station worked is a leading "SS" man or a ham outside the contest. If one breaks his power class, however, the Total Score is the *sum of scores separately computed* for each power class and added.

Scoring system in brief:

All contacts:

One point for each QSO when "receipt" is completed for an exchange one way.

Two points for each QSO when the required information is exchanged both ways.

For final score:

Multiply totaled points by the number of different A.R.R.L. Sections<sup>2</sup> worked, that is, the number in which at least one *bona fide* S.S. point or exchange has been made.

Multiply this<sup>4</sup> by 1.25 if you used 100 watts or less for transmitter input.

### Additional Rules

1. Information in contest exchanges (six parts) must be sent in the order indicated, that of the A.R.R.L. message preamble. Incomplete exchanges or wrong order of sending justifies disqualification.

2. Entries should be (a) in the low-power class, or (b) high-power class, or submitted as the sum of separately computed work at one station falling in each class. Sections worked on high power do not count in the multiplier for low-power-score and vice versa. Logs must show the power used for each QSO or for groups of QSOs.

<sup>4</sup> If the power was changed between (a) or (b) during the contest, separate scores must be kept for each power class, and the two added together for the total.

STATION W . . . SUMMARY OF EXCHANGES 10TH A.R.R.L. ALL-SECTION SWEEPSTAKES															
Freq. Band (mc.)	Time On or Off Air	NR	SENT (1 point)				RECEIVED (1 point)				Time	Date (Nov.)	Number of each Different New Section as Wk'd	Points	
			Stn.	CK-RST	Place	Time	NR	Stn.	CK-RST	Place					
3.5	On 6:10 P.M.	1	W1AW	579	W. Hartford, Conn.	6:15 P.M.	12	3	W1GME	589	Middlebury, Conn.	6:18 P.M.	12	1	2
"	"	2	"	439	W. Hartford, Conn.	6:25 P.M.	12	7	W1BHM	479	New Haven, Conn.	6:30 P.M.	12	..	2
"	"	3	"	587	W. Hartford, Conn.	6:40 P.M.	12	2	W3BKZ	389	Chevy Chase, M.D., D.C.	6:45 P.M.	12	2	2
7	"	4	"	498	W. Hartford, Conn.	10:18 P.M.	12	3	W8BEN	569	Rochester, W. N. Y.	10:24 P.M.	12	3	2
"	"	5	"	578	W. Hartford, Conn.	1:25 A.M.	12	7	W9TSV	589	Chicago, Ill.	1:15 A.M.	12	4	2
"	Off 3:00 A.M. 8 hours 50 min. On 1:00 P.M.	6	"	549	W. Hartford, Conn.	2:50 A.M.	12	15	W9VKF	479	Minneapolis, So. Minn.	2:55 A.M.	13	5	2
14	"	7	W1AW	479	W. Hartford, Conn.	2:15 P.M.	20	14	W5WG	339	Ruston, La.	1:05 P.M.	20	6	1
7	"	8	"	588	W. Hartford, Conn.	3:00 P.M.	20	17	W5BDI	459	Houston, So. Tex.	2:30 P.M.	20	7	2
"	"	9	"	578	W. Hartford, Conn.	4:06 P.M.	20	11	W1EWD	589	New Britain, Conn.	2:55 P.M.	20	..	2
"	"	10	(W5WG) W1AW	347	W. Hartford, Conn.	4:30 P.M.	20	16	W6MVK	439	Modesto, S. J. V.	4:31 P.M.	20	8	2
"	Off 5:20 P.M.	11	"	479	W. Hartford, Conn.	5:10 P.M.	20	9	W9IPT	579	Wheaton, Ill.	5:15 P.M.	20	..	2
4 h. 20 m. 13 h. 10 m.												8 Sec. 22 pts.			
3.5, 7 and 14 mc. used. 85 watts Input Power															

Number and name of operators having a share in above work .....  
 Claimed score: 22 points × 8 Sections = 176 × 1.25 (85 watts input) = 220.  
 I hereby state that in this contest I have not operated my transmitter outside any of the frequency bands specified on my station license, and also that the score and points set forth in the above summary are correct and true.

Signature .....  
 My Tube Line-up ..... Address .....  
 Number Different Stations Worked .....

## EXPLAINING CONTEST EXCHANGES

<i>Send Like Std. Msg. Preamble</i>	<i>NR</i>	<i>Call</i>	<i>CK</i>	<i>Place</i>	<i>Time</i>	<i>Date</i>
In the "SS" Exchanges.....	Number contest info. sent consecutively, 1, 2, 3, etc., a new nr. for each station worked	Send your own call	CK is RST report <sup>5</sup> of station worked	Your city and section <sup>2, 5</sup>	Send time of transmitting this "NR"	Send date of QSO
Purpose.....	The QSO-nr tells how you are doing; aids Hq. checking	Identification	All stations exchange complete reports	The A.R.R.L. Section is vital contest data	Time and date must check in both logs and fall within the contest period to prove each point claimed	

<sup>5</sup> Send the letters CK and just the three number RST report. In 'phone exchanges only two numerals need be used. Make a habit in all 'phone reports of saying, READABILITY . . . STRENGTH. . . . This avoids confusing abbreviations. It is best radiotelephone practice *always* to avoid use of abbreviations. Instead of just the state (which is the same as the Section in many cases), identify your A.R.R.L. Section as, for example, Salem, Eastern Mass.; Providence, R. I.; Buffalo, W. N. Y.; Omaha, Neb.; Oakland, E. Bay, etc.

3. Reports must show operating time for each period spent on the air in the "SS," and the total of such operating time.

4. Logs must be marked for "phone" or "C.W." entry, grouping all work by either method together as one score.

5. All work must fall in the contest period.

6. Decisions of the award committee of C.D. staff members shall be accepted as final.

7. Reports must be received at A.R.R.L. Hdq. from all stations except those in Alaska, Hawaii, and P. I. on or before noon, Dec. 22, 1939, to be considered for certificate awards. From outlying points, reports must similarly be received on or before Jan. 19, 1940.

List all operators<sup>7</sup> whose work at your station is responsible for any part of the score.

All active ham operators are invited to take part and report. You will work a new bunch of stations, make new records for your station, get QSL cards (be sure to send one for each QSO), have a lot of fun, meet new friends, and perhaps rate an A.R.R.L. award at the conclusion. Do your best operating. Send A.R.R.L. the results for *QST* mention. MAIL YOUR REPORT IMMEDIATELY AT THE END OF THE CONTEST TO AVOID DELAY AND INSURE THAT YOUR RESULTS ARE CREDITED AND KNOWN THROUGH *QST*.

### Club Participation

Certificate awards (besides the 'phone and telegraph Section awards) will be made through each club where three or more individual club members, or new hams invited and reported by such a club, in addition to sending a contest report have their club secretary write Hq. listing their individual calls and scores, and the total of such scores. Only the aggregate of scores confirmed by receipt here of Contest Logs shall count for the club. If there are both club 'phone and c.w. entries, A.R.R.L. will provide two certificate awards for the club to give its leading members. The sum of the scores of all club participants ('phone and c.w.) confirmed by logs will be added by the secretary, to count for the club!

A genuine gavel, with engraved sterling silver band, is offered as an award to that club whose officers or activities' manager submits the greatest collective score from "SS" logs. Club members must send in full reports either direct or through the secretary to substantiate the club's claim on the gavel award! A chance to win honors for your club and a valuable trophy for the club's presiding officer to use at meetings!

Competition comes only from operators in one's immediate Section. Awards are for the operator running up the best communication record for each Section (as indicated by the score). Operators thus have equal DX conditions and operating opportunity. Fullest operating enjoyment is assured. See May *QST* for full details on the last SS or ask any amateur who took part last year!

### Reporting Results

Report<sup>6</sup> to A.R.R.L., West Hartford, Conn., as soon as the contest is over. Use the log form shown in the example.

<sup>6</sup> All hams are requested to submit lists, even if they only show a small score, on a postal. By doing this they help

support claims made in logs from other stations and receive credit in *QST*.

<sup>7</sup> The highest individually-attained score of any one of the operators of amateur stations having more than one operator is the official score for such a station. The summary of score must show all stations worked by all operators however, circling the entries of stations and/or Sections that cannot count in the official total. Awards will be based on the official total and will be made to the individual operator accredited with this total. To show the possible scores that can be built up by several operators at one station, such scores (all Sections listed by all points listed) may be shown parenthetically after the "official" score that counts toward a possible award.

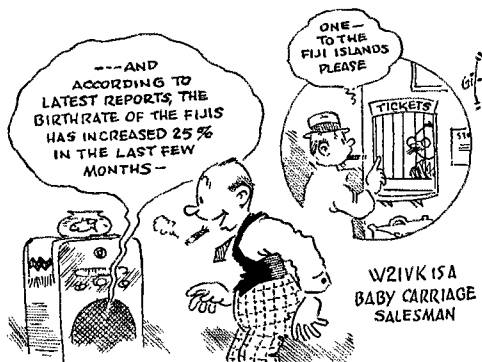

# Pointers on Design and Adjustment of High-Efficiency Grid-Modulated Amplifiers

*Experimental Transmitters Using the Terman-Woodyard System*

BY CHARLEY W. WINKLER,\* W9AKC

THE high-efficiency grid-modulated amplifier<sup>1</sup> realizes the high efficiency of plate modulation while still retaining the chief advantage of grid modulation — low audio power requirements. This type of amplifier can provide a carrier output approaching that obtainable in a Class-C amplifier plate modulated, and the initial cost of the equipment is low compared to the first cost of a plate-modulated transmitter.

The high-efficiency grid-modulated amplifier is similar in some respects to the Doherty high-efficiency linear amplifier;<sup>2</sup> the principal differ-

## The Plate Circuit

The most difficult adjustment to be made is that of the plate phasing network. We can visualize this part of the circuit quite easily, however, since it is similar to the pi-section matching network that amateurs have used for a long time to couple the output of a transmitter to an antenna (Fig. 1). The network is used in this application to provide impedance inversion. Consider a network of  $X$  ohms characteristic impedance, terminated in resistance of  $R$  ohms equal to  $X$ . The sending-end impedance will then be equal to  $R$  ohms. If

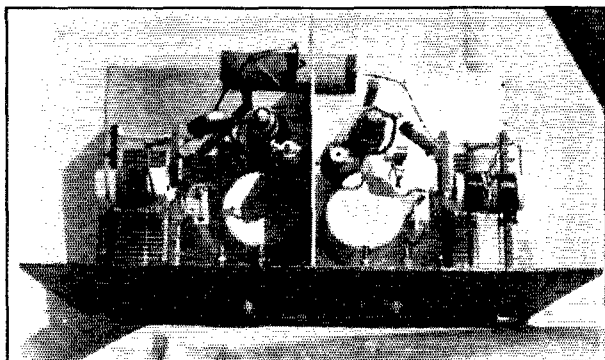

A top view of the experimental amplifier using 6F6-100's. The plate phasing coil projects through the baffle shield between the two stages. Amplifier tank coils are mounted on top of their respective condensers. The shield cans contain the grid coils.

ence is in the way modulation is applied. The Doherty amplifier is driven by a wave already modulated, while the audio signal is applied directly to the amplifier in the grid-modulation system. Another difference exists, however, which makes the high-efficiency grid modulated-amplifier much more practical for the use of the amateur. Terman and Woodyard have developed a tuning method, and have shown the mathematical derivation for it, which greatly simplifies the problem of adjustment. The tuning of the high-efficiency grid-modulated amplifier is done by using only the conventional grid and plate meters to show correct adjustment.

\* Supervisor, KFAB Transmitter; 3811 J Street, Lincoln, Neb.

<sup>1</sup> Terman and Woodyard, "A High-Efficiency Grid-Modulated Amplifier," *Proc. I.R.E.*, August, 1933.

<sup>2</sup> Doherty, "A New High-Efficiency Power Amplifier for Modulated Waves," *Proc. I.R.E.*, September, 1936.

the terminating resistance is changed to  $R/2$  ohms the sending end impedance will be  $2R$  ohms. The phase through the network of Fig. 1-A will be retarded 90 degrees while that of Fig. 1-B will be advanced 90 degrees, and this phase shift will not be dependent upon the value of  $R$ . The sending end impedance is given by the relation

$$Z = \frac{X^2}{R}$$

The inductive reactance of the phasing coil in the elementary circuit, Fig. 2, is made equal to the impedance the tube should look into as a Class-C amplifier when working at peak level (100% modulation conditions). This value is determined from the allowable plate dissipation, filament emission, and permissible direct plate voltage. The value of plate dissipation during

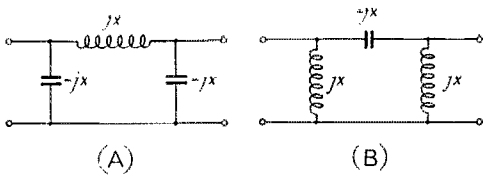

Fig. 1 — Matching sections equivalent to a quarter-wave line. The reactances in each branch are equal.

modulation can be made somewhat higher than for Class-C telegraph conditions because the tube is operating at peak level only a small period of time. The value of direct plate voltage may be made higher than for plate modulation because the tube is not subjected to the voltages, on peaks of modulation, that it would encounter in plate modulation.

### Operating Conditions

The following method can be used to obtain the general operating conditions. Assume that we want a total carrier equal to that which we could have by using two tubes, say, HF-100's, in a plate-modulated Class-C amplifier. The manufacturer's rating for one HF-100 plate modulated is 105 watts output. The c.w. telegraph rating, however, is 170 watts, so by permitting a small overload we may choose a total carrier power of 200 watts as the desired output from a high-efficiency grid-modulated amplifier.<sup>3</sup> This as-

<sup>3</sup> The particular operating conditions discussed here have the tube manufacturer's sanction, since the maximum plate current subsequently found is within the capabilities of the tube, while the average plate dissipation is very little, if any, above normal. The factors to be considered in determining the permissible power output from any of tube are the plate dissipation under modulation conditions, and the total emission of the filament. The peak demand on filament emission will depend upon the operating angle and the grid characteristics. A tube should be capable of a carrier output of twice its normal plate-modulated rating provided the increased output can be obtained without exceeding the maximum permissible plate dissipation. This requires fairly high plate efficiency, depending upon how the tube originally was rated. Demands on filament emission will be lessened by obtaining the increased input largely by an increase of plate voltage, rather than by increased plate current. — EDITOR.

The symmetrical arrangement of the two sections of the amplifier is continued below the chassis. The grid tuning condensers are mounted on the front edge of the chassis (bottom edge in the photograph). The grid phasing condenser is just above the left-hand grid-tuning condenser.

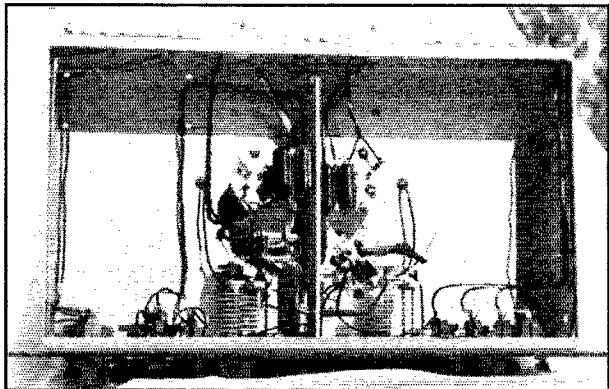

Experience in building and adjusting two 20-meter 'phone transmitters using the high-efficiency grid-modulated amplifier of Terman and Woodyard has given the author a practical background which makes the information contained in this article of real value. A careful reading will help in estimating the relative merits of the system, for particular ham problems, as compared to conventional plate modulation.

sumed value may be slightly high or low, and can be changed if final results indicate that this is necessary.

Since tube No. 2 does not supply power at carrier level, while tube No. 1 supplies all the carrier power, the following computations are directed at tube No. 1. If tube No. 1 is supplying a carrier of 200 watts, then on peaks of modulation it will have to supply an output of 400 watts (tube No. 2 also supplies 400 watts on peaks of modulation to provide the necessary peak power of 800 watts). High efficiencies are readily obtainable so the d.c. power input to tube No. 1 at peak level will be (using an efficiency of 75%) 400/75% or 533 watts. At the plate voltage used for Class-C telegraph service, 1500 volts, the plate current will be 533/1500 = 356 ma. on peaks.

For an approximate value of load impedance into which a Class-C amplifier works, Spitzer<sup>4</sup> gives the relation: plate voltage divided by twice the plate current. The load impedance that tube No. 1 should look into on peaks of modulation is 1500 / (2 × 0.356) = 2100 ohms.<sup>5</sup> The average plate loss with full modulation is<sup>1</sup>

<sup>4</sup> Spitzer, "Grid Losses in Power Amplifiers," *Proc. I.R.E.*, June, 1929.

<sup>5</sup> The method outline by Denton ("High Efficiency Grid Modulation in a Portable 14-Mc. Phone Transmitter," *QST*, July, 1939) may also be used for determining the load impedance. It gives a slightly higher value when the factor 0.9 is used as the ratio of peak r.f. plate voltage to d.c. supply voltage. Either formula can be used as a basis of design, however, since the actual load can be varied considerably in the adjustment process. — EDITOR.

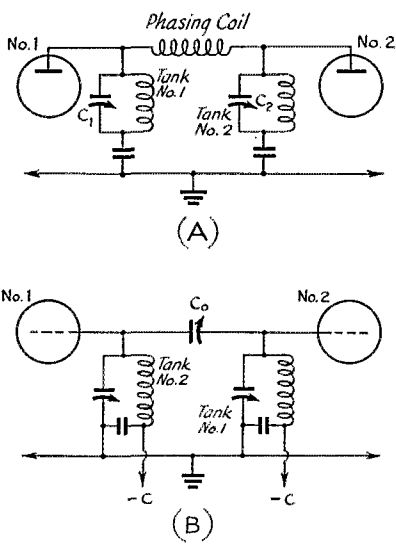

Fig. 2 — Essentials of practical circuits to produce the effect of the quarter-wave matching sections of Fig. 1. The end reactances are secured by detuning the tanks.

$$P_0 \left( \frac{1-s}{S} + \frac{M}{\pi} - \frac{M^2}{4} \right)$$

where  $P_0$  is the carrier output,  $s$  is the efficiency and  $M$  the modulation factor. For 75% efficiency and 100% modulation the plate loss is

$$200 \left( \frac{1-0.75}{0.75} + \frac{1}{\pi} - \frac{1}{4} \right) = 80 \text{ watts}$$

The value of plate current for carrier conditions is half the maximum value of 356, or 178 ma. This value of plate current will give a plate loss at carrier level which is less than rated plate dissipation. The carrier input is  $175 \times 1500$ , or 267 watts, which less the output of 200 watts, gives a plate loss of 67 watts.

If the plate loss were strictly limited to 75 watts and it were necessary to modulate continuously at 100% with a sine wave, the above values would be too high and a new value for carrier output would have to be used which would give a plate loss, under modulation, not exceeding the rating of the tube. It is permissible to use the tube under the conditions given above because average percentage of modulation over a period of time is considerably less than 100%.

**Circuit Operation**

Tank circuits 1 and 2 are detuned from resonance to provide a capacitive reactance equal to the reactance of the phasing coil. This detuning on 14 Mc. is very slight, being only a few  $\mu\text{mfd.}$  for impedances from 2000 to 5000 ohms. The design of these tank circuits should take this into consideration, so that a reasonable variation of the tank condenser capacity can be secured before reaching either the maximum or minimum setting.

The two tank circuits provide the capacitive

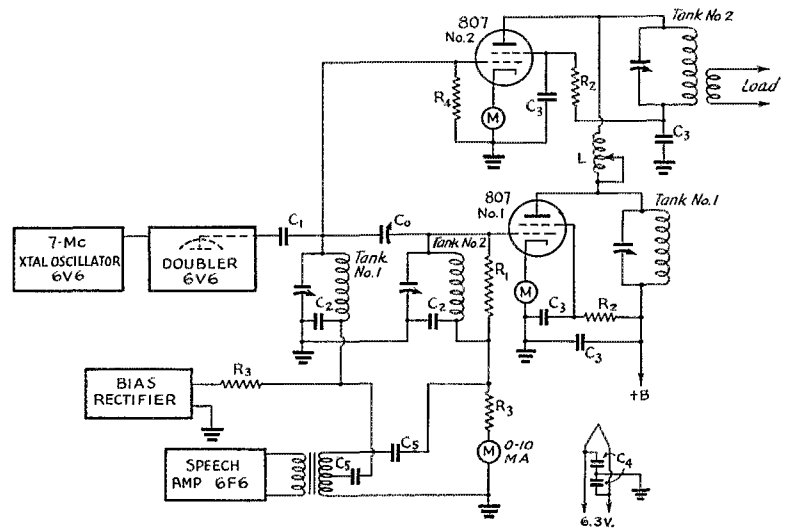

Fig. 3 — Circuit diagram of an experimental transmitter using 807's. The carrier output secured was approximately 50 watts.

- $C_0$  — 3-6  $\mu\text{mfd.}$  midget variable.
- $C_1$  — 0.001- $\mu\text{mfd.}$  mica, 500-volt.
- $C_2$  — 100- $\mu\text{mfd.}$  mica, 500-volt.
- $C_3$  — 0.001- $\mu\text{mfd.}$  mica, 1000-volt.
- $C_4$  — 0.01  $\mu\text{fd.}$
- $C_5$  — 1- $\mu\text{mfd.}$  paper, 500-volt.
- $L$  — 36 turns No. 17 s.c.c. on  $1\frac{1}{2}$ -inch form, close-wound. Conventional tank circuits are used.
- $R_1$  — 3000 ohms, 1-watt.
- $R_2$  — 35,000 ohms, 20-watt.
- $R_3$  — 10,000 ohms, 1-watt.
- $R_4$  — 90,000 ohms, 1-watt.

reactance which with the coil make up the quarter-wave line. Tube No. 1 is located at the sending end of the line and tube No. 2 at the terminating end. The resulting action of the combination is such that under carrier conditions tube No. 1 looks into an impedance of  $2R$  ohms, with the network of characteristic impedance  $X$  (equal to  $R$  ohms) terminated in  $R/2$  ohms. As modulation is applied, tube No. 1 looks into a gradually lowering impedance reaching the value of  $R$  at the up-peak of 100% modulation. The terminating impedance of the network consists of tank No. 2, loaded by the antenna or any useful load, with tube No. 2 in parallel. The effect here is that of a negative resistance shunted across the tank circuit, and as the power delivered by tube No. 2 increases, the terminating resistance also increases, thus causing the sending-end impedance to decrease. Modulating voltages are applied to tube No. 1 to lower its internal resistance so that as its load impedance decreases it can supply additional current to the load. At 100% modulation tube No. 1 is supplying twice carrier level at no increase of r.f. voltage (this was already at maximum under carrier conditions) so the increase in output is effected because of the increase of output current.

### Adjustment

The method of adjusting the plate phasing network as suggested by Terman and Woodyard is to place a load resistance of  $R/2$  ohms across tank No. 2 (with the filament of tube No. 2 disconnected but with this tube in its socket so that its capacitance will be present) with reduced plate voltage, normal excitation and normal bias on tube No. 1. Under these conditions the condenser of tank No. 1 is adjusted for minimum plate current and the condenser of tank No. 2 adjusted for maximum plate current on tube No. 1. The setting for  $C_1$  will be dependent upon the setting of  $C_2$  in much the same manner as the two condensers in a pi matching network are dependent upon each other. The correct conditions are achieved when any further adjustment of  $C_2$  will produce no further rise in plate current and the adjustment of  $C_1$  will produce no further decrease in plate current.

This procedure gives correct adjustment of the network but does not insure that it is of the correct characteristic impedance. To adjust for the correct value of impedance disconnect the phasing coil and place a resistance of  $2R$  across tank No. 1, which is tuned for minimum plate current with

(Continued on page 108)

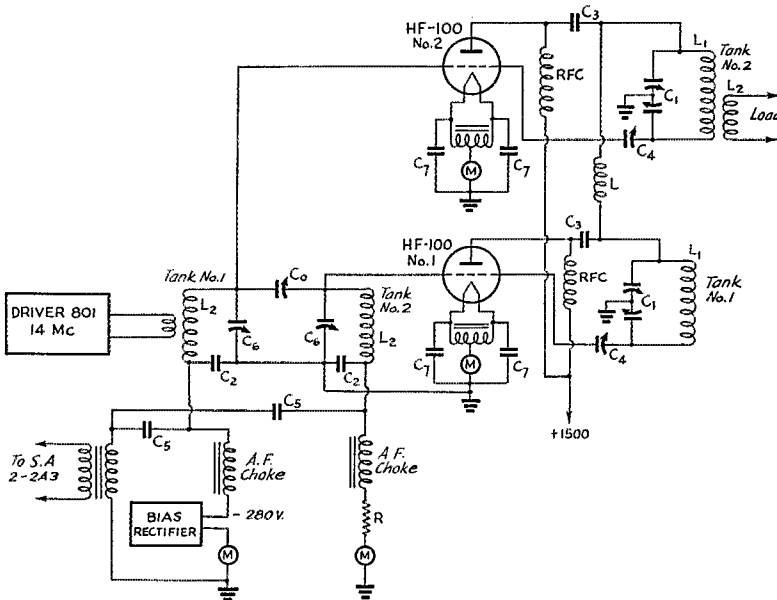
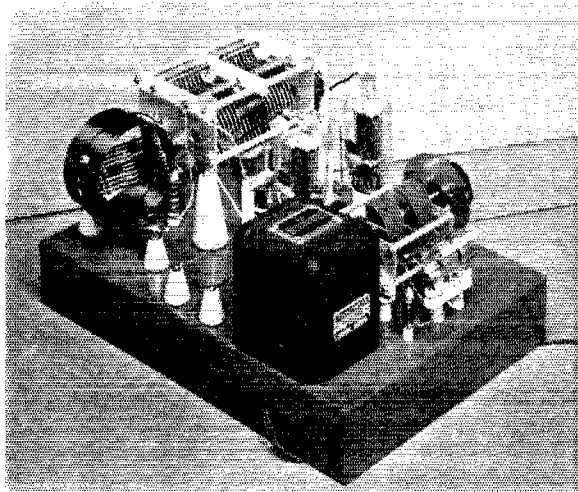

Fig. 4 — Circuit of the transmitter using HF-100's.

- $C_0$  — 3-6  $\mu\text{fd.}$ , midget variable.
- $C_1$  — 50- $\mu\text{fd.}$  (total) split stator, 0.07" air-gap (Cardwell MT-100-Gd).
- $C_2$  — 100- $\mu\text{fd.}$  mica, 1000-volt.
- $C_3$  — 0.001- $\mu\text{fd.}$  mica, 2500-volt.
- $C_4$  — Neutralizing condenser, 10  $\mu\text{fd.}$  max.
- $C_5$  — 1- $\mu\text{fd.}$  paper (audio coupling).
- $C_6$  — 50- $\mu\text{fd.}$  transmitting midget.

- $C_7$  — 0.01  $\mu\text{fd.}$
- $R$  — 10,000 ohms, 10-watt.
- $L_1$  — 30 turns No. 17 s.c.c. close-wound on  $1\frac{1}{2}$ -inch form
- $L_2$  — 12 turns No. 12, diameter  $1\frac{1}{4}$  inches.
- $L_3$  — 8 turns on  $1\frac{1}{2}$ -inch form.

Note: Inductance of tank coils adjusted (by varying turn spacing) to resonate at mid-scale on tank condensers.



While the idea of ganging a variable inductance and variable condenser is not new to the art, nothing much seems to have been done about applying it to ham transmitters. Here's some dope on the performance of an experimental ganged unit which has given a good account of itself.

The variable-inductance coil ganged with the tuning condenser in the plate tank circuit of an experimental amplifier using RK-51's at an input of 450 watts.

**Constant L/C Ratio; Switchless Three-Band Tuning**

## A Single-Control Wide-Range Tank Circuit

BY T. M. FERRILL, JR.\* W1LJ1

**P**LAG-IN coils for transmitter tanks are marked not only by good efficiency and moderate cost, but also the inconvenience of external coils and the bother of getting into various stages of the transmitter to remove and replace them. Also, a full set of plug-in coils sometimes proves to be much more expensive than the associated tuning condenser.

Second in popularity to the plug-in coil tanks are those incorporating front-panel controlled turns-shortening switches. While a marked advance in operating convenience is provided by tanks of this type; efficiency, low stray capacities, circuit balance, and simplicity of loading are likely to be sacrificed.

In the ganged coil-and-condenser tuner shown at the left in the accompanying photograph, the shaft of a split-stator plate tuning condenser is mechanically coupled to the rotor coil of a unit somewhat resembling the old variometers. In contrast to the variometers used for early receiver and transmitter tuning, however, the number of turns on the rotor is less than half that of the stator section. In spite of the small number of rotated turns, an inductance range greater than 4 to 1 is provided by the variable inductance coil, so that with a condenser having an equivalent effective maximum-minimum capacity ratio a four-to-one frequency range can be covered.

In practical operation this combination of coil and condenser on a single tuning shaft has been highly satisfactory. It was expected at first that

\*National Company, Malden, Mass.

the variable inductance would reduce the plate tank efficiency, but actual tests indicated a high order of efficiency throughout the tuning range. Minimum plate current on the 1.75-, 3.5- and 7-Mc. bands with 1200 volts applied to the plates of the push-pull amplifier at constant rated grid excitation gave a minimum (unloaded) plate current of 20 ma. on each of the three bands.

The minimum plate current of an unloaded r.f. stage with fixed excitation, bias, and plate voltage serves as a good practical criterion of comparative tank-circuit efficiency, with high minimum current values usually indicating low tank efficiency, provided the comparisons are made between tanks having the same  $L/C$  ratio.

### Loading

It was anticipated that a link output coil having the correct number of turns for loading on one band, with a fixed non-inductive load, would provide reasonably constant loading throughout the entire tuning range — that is, loading varying perhaps from 200 ma. to 300 ma. in a stage normally designed for 250-ma. plate current. Here again expectations were exceeded and the current values were found to vary only from 240 ma. to 250 ma.

This characteristic is an important one, since a single link coil may be wound on the final-amplifier tank coil to match similar transmission lines used for three antennas, with correct amplifier loading being provided automatically at the frequencies of the three antennas. Further-



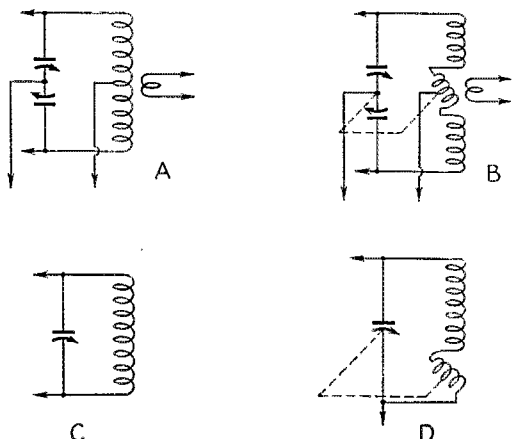

Fig. 1—As these drawings clearly show, the circuit arrangement is perfectly orthodox.

more, with tanks of this type used for grid and plate circuits of link-coupled stages, one adjustment of the coupling turns at the grid and plate coils should serve for proper loading and excitation on three bands.

### Uniform $L/C$ Ratio

The mechanically-coupled coil and condenser system is inherently well suited to design of a tank with fairly constant  $L/C$  ratio. Capacity variation of most transmitter tuning condensers is almost linear with rotation, the greatest departure from linearity occurring at the very minimum-capacity end of the tuning range. Although the inductance variation is not linear, it is sufficiently near a straight line to hold the  $L/C$  ratio within close limits throughout the tuning range. Actually, the coils of the variable inductance could be proportioned for greater variation of inductance than of capacitance, or the reverse. The nearly constant ratio, however, is a very desirable feature. The constants given work out to a tank  $Q$  of 6 for the amplifier with which the tank is used.

Fig. 2—Practical circuit diagram using the ganged tank. The variable tank coil,  $L_2$ , has 21 turns of No. 14 on the outer coil and 9 turns of No. 10 on the inner. Diameter of the outer coil is 4 inches, of the inner,  $3\frac{1}{2}$  inches. Both coils have a length of  $2\frac{1}{2}$  inches. The coil is ganged to a National TMA-200D condenser, which has a maximum capacity of 200  $\mu\text{fd}$ . per section with 0.077-inch spacing. Other circuit values will depend upon the tubes used. For the experimental unit shown:

- $C_1$ —Grid tuning, 356  $\mu\text{fd}$ . per section.
- $C_3, C_4$ —Disc-type neutralizing condensers.
- $C_5$ —0.002- $\mu\text{fd}$ . mica.
- $C_6, C_7$ —0.01  $\mu\text{fd}$ .
- $C_8$ —0.002- $\mu\text{fd}$ . mica fixed, 5000-volt.
- RFC<sub>1</sub>—125-ma. r.f. choke.
- RFC<sub>2</sub>—600-ma. r.f. choke.
- T—Filament transformer.
- $L_1$ —Center link plug-in grid coils (National AR16 series).

### Balanced or Unbalanced

The tank used in the plate circuit of the transmitter in the photograph is well balanced at all settings of the rotating coil. Neutralization remains fixed throughout the entire tuning range. The inductance unit used in this r.f. amplifier is suited also to use in a single-ended or unbalanced tank circuit, such as the usual plate tank arrangement for an r.f. pentode or beam-power tube. In such a single-ended tank, the connection to the center of the rotated coil would of course, be omitted.

### Construction

Outer and inner coils of the variable inductance are "air-wound." Specifications are given in Fig. 2. A  $\frac{1}{4}$ -inch diameter bakelite shaft is passed through small semi-circular bends in the center turns of the coils. The shaft is supported and centered by the turns of the outer coil, and the turns of the inner coil rest on it, giving a pressure bearing for rotation of the inner coil. Connections between the center divided turn of the outer coil and the ends of the rotor are made by means of two pigtail connections running along the condenser end of the bakelite shaft. A third pigtail connection from the center of the rotor is carried through the back of the assembly for d.c. supply. This, of course, is a brief description of a unit built simply for experiments. More rigid and dependable construction for the rotating assembly is considered highly desirable for mechanical permanence, and readily could be devised.

The link coil is wound in usual fashion around the middle of the tank coil. Coupling is tightened or loosened by increasing or decreasing the number of turns in the link winding. For use in unbalanced circuits, with one end of the tank coil operated at ground r.f. potential, the link turns should be wound near the "ground" end of the coil rather than at the center. If a considerable amount of metal is used in the rotating mecha-

(Continued on page 61)

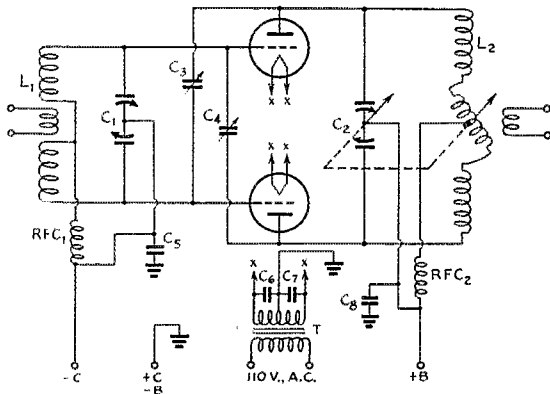

# Scores, VE/W Contact Contest, 1939

BY ROMEO LEONARD,\* VE2HZ

THE 1939 Canada-U.S.A. Contest was very well received and thoroughly enjoyed by the many participants. Scores reached new highs, although the contest duration was of fewer hours than in previous years. There was plenty of activity in the forty-eight hours of the April 14th-16th week-end. Logs were received from 119 VE's and 258 U. S. participants.

Certificates of Merit are being awarded the leader in each A.R.R.L. Section. Additional awards go to the highest scoring of all participants in Canada and in U.S.A. Sections. The fifteen highest scorers among VE's and the fifteen highest W's follow:

<b>CANADA</b>		
1	VE3SF	41067
2	VE2FG	35862
3	VE2EE	35250
4	VE3APD	33035
5	VE5ZM	32971
6	VE3GT	32100
7	VE3ES	30982
8	VE3AJX	30870
9	VE5VO	30378
10	VE4AGA	29751
11	VE4SO	28411
12	VE4ZC	26841
13	VE3KE	25542
14	VE4EO	24604
15	VE3DH	24058

<b>UNITED STATES</b>		
1	W2IOP	30429
2	W8JIN	24759
3	W2JKH	24003
4	W9UTB	23058
5	W1TS	23058
6	W3BES	22491
7	W1EZ	21546
8	W9MLB	21357
9	W8HGW	20412
10	W8CMH	20034
11	W8NTJ	20034
12	W8GJY	19845
13	W9VDY	19467
14	W2EGG	18711
15	W9EYH	18144

### Disqualifications

We have verified carefully the reports of these stations and we have asked confirmation from numerous amateurs shown worked in their reports. Due to the declaration of a sufficient number of such operators certifying "no contact" on the dates in question, it has been deemed necessary to declare the following three stations disqualified, and therefore their scores do not appear: VE2EP, VE3QP, VE3AHV.

### Score Listings

Scores are listed by Divisions and Sections, the winning station being first listed in each case.

\* Director of Survey, 1939 W/VE Contest Committee, Les Amateurs Canadiens-Français de la T.S.F., Lapalestre Nationale, 340 Cherrier Street, Montreal, Quebec.

The following information accompanies the scores: (1) Number of message preambles sent; (2) Number of message preambles received; (3) Number of contacts confirmed by cross-checking all logs received; (4) Number of A.R.R.L. Sections worked. Our hearty congratulations to all winners.

<b>CANADA</b>					
	Score	Message Sent	Preambles Received	Contacts Confirmed	Sections Worked
<b>MARITIME DIVISION:</b>					
VE1EV	16848	159	153	74	36
MK	12528	120	112	59	36
AU	12189	120	119	56	34
EA	11520	162	158	69	36
CU	10834	119	114	53	31
OM	2652	52	52	25	17
ME	2448	49	47	23	17
DB	2214	42	40	19	18
OR	1710	38	38	11	15
HP	1599	41	41	10	13
<b>ONTARIO DIVISION:</b>					
VE3SF	41067	255	252	125	54
APD	33035	238	232	113	47
GT	32100	220	208	108	50
ES	30982	204	201	99	51
AJX	30870	210	210	110	49
KE	25542	195	192	104	44
DH	24058	188	185	106	43
AET	22263	183	179	98	41
ALB	21942	160	158	90	46
AWX	19147	176	169	90	37
XQ	19074	187	187	17	51
JS	18880	154	153	98	41
EK	18774	150	148	76	42
HB	16576	129	128	70	43
AYE	14880	126	122	66	40
ARK	14683	130	121	69	39
AMK	13486	122	121	57	37
AUQ	13221	124	102	65	39
HE	13117	138	127	74	33
BC	11997	131	127	8	31
NA	11781	116	115	65	34
AQG	11616	123	114	72	32
EF	10927	118	117	77	31
AGB	10791	109	109	71	33
AXQ	10626	130	123	76	28
KC	9960	125	124	76	40
AGX	9936	96	88	61	36
AQB	8466	84	82	55	34
AQC	7089	77	62	37	34
YZ	6786	117	117	73	29
IW	6768	71	70	52	32
DU	6579	67	62	41	34
EM	5313	81	80	54	22
ATY	5148	78	78	50	22
ASM	4933	127	126	74	13
ASJ	4320	99	91	54	23
APG	4212	56	52	43	26
ATR	3996	57	54	40	24
VJ	3078	57	57	34	18
PE	2814	67	67	41	21
JP	2677	60	57	37	15
FC	2304	48	48	29	24
ZE	2232	47	46	32	16
ATC	2115	52	42	38	15
RF	1596	30	26	8	19
AMM	1190	43	42	21	14
WH	1152	24	24	16	16
ACQ	1035	23	23	4	15
ACB	690	23	23	17	10
AKW	352	22	22	7	8
KK	320	16	16	13	10
ATF	153	10	7	1	6



# A Safety Kilowatt Transmitter

*Some Ideas in High-Power Transmitter Construction*

BY W. T. BISHOP,\* W9UI

**A**LTHOUGH the transmitter that is absolutely safe in the hands of a careless person has not yet been built, many steps can be taken to improve the present practice in the construction of amateur transmitters. One has only to read the past year's copies of *QST* to prove this point. The transmitter described here has been built with the express idea of seeing just what can be done with available equipment toward building a safe compact kilowatt. There are without doubt other precautions that could be incorporated; however, I believe the most important points have been protected with safety devices.

Of first importance is, of course, the housing of the transmitter in a steel cabinet, and the door to the cabinet must be provided with an interlock switch so that the a.c. line is broken when the cabinet door is opened. A Bud CR1772 cabinet was selected for the job, since it has room built in for door interlock switches. Another potential hazard that exists in the majority of rack-panel transmitters is the plate meters connected in the positive side of the high-voltage line. From the beginning it was decided to place all meters in the negative lead, and surprisingly few complications over the conventional system were encountered in doing so. In the oscillator and buffer-doubler stages the meter was simply placed in the cathode circuit. This has the disadvantage that the meter reads the total plate, screen and control-grid current but it can easily be overlooked, since the control-grid current is small and the screen current is small when the plate current is increased upon loading. Resonance is indicated by a less pronounced dip in the current due to the screen current and control-grid current rising as the plate current dips. In the case of the driver and final stages there were two possible methods that could be used. Fig. 1A shows the method used in the oscillator and buffer-doubler stages. However, this method reads both grid and plate current and was considered a disadvantage in the case of a triode, since the grid current can so easily be separated from the plate current by one change in the connection, as shown in Fig. 1B. This method of metering not only makes the meter safe to the operator<sup>1</sup> but also protects the meters from possi-

ble breakdown to ground. Although only 100 watts is dissipated in the bleeders, 200-watt bleeders were used, with the idea of making them more dependable. Then, too, some allowance must be made for resistors mounted under the chassis, where the air circulation is not quite as good as it is in the open and the resistors cannot be used at full rating.

## *The Push-Pull TW-150 Amplifier*

In keeping with modern practice, the transmitter was designed to work in the amateur bands from 3.5 to 30 Mc. This required careful selection of the tank condensers, since they had to have a low enough minimum capacity to tune to 10 meters and still be high enough on 80 meters. Spacing that would stand 3000 volts and 100% modulation was necessary in the condenser, but its size had to be such that it would fit on a standard chassis pan. The condenser finally selected was the Johnson 100DD90, which has a flashover per section of 9000 volts and is approximately 16½ inches long. This length dictated that the

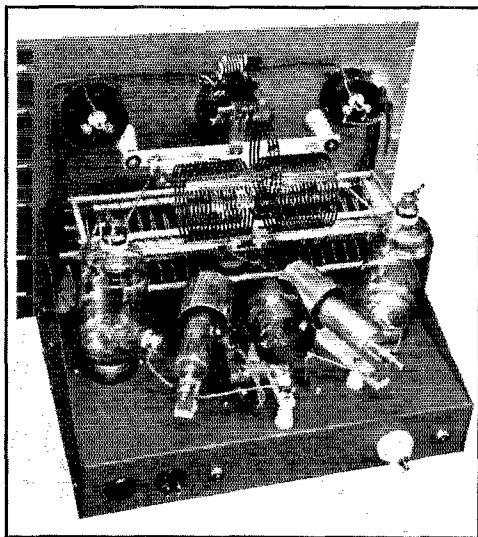

The final amplifier uses a pair of TW-150's and features mounting the tuning condenser parallel to the front panel, the rotor being driven through gears at the center of the rotor shaft. Short leads are obtained by mounting the neutralizing condensers in a horizontal position. The loop hung on the meter at the right is used to pick up r.f. for the monitoring oscilloscope. It is connected to the cable connector at the extreme right on the chassis.

\* Engineering Dept., Taylor Tubes, Inc., Chicago, Ill.

<sup>1</sup> Strictly speaking, this does not comply with the Safety Code principle that one side of all meters must be grounded. However, in this case the grid meter can only be above ground by the drop across the plate meter, which will be small unless the plate meter opens up. A 25-ohm 25-watt resistor across the plate meter would be an additional precaution. — Ed.

condenser be mounted parallel with the panel, since the cabinet is only 16 inches deep. The condenser fitted beautifully along the front of the chassis but this made it difficult to connect a dial to the condenser shaft. However, a bit of thinking revealed that this condenser, like many other makes of split-stator condensers, could be driven from the center by the use of suitable gears. The 100DD90 was partially disassembled and a mitre gear installed between the two rotor sections so that a similar gear would drive the shaft at the center. The operation was not difficult, and it could be done with only a hack saw, drill and a file, if a lathe were not available. The gears used were from the Boston Gear Works, catalog No. G465, and cost about one dollar. A small bracket, to hold the shaft of the driving gear, was fastened

to one of the tie rods, and this bearing along with a standard panel bearing mounted on the front panel made a substantial mechanical assembly.

In order to increase the flashover point of the tank condenser, the d.c. was removed from across the condenser sections as described in the December, 1938, issue of *QST*. This required that the condenser be mounted on good stand-off insulators and that the shaft be well insulated from the panel and dial. One-inch steatite cone insulators were used to mount the condenser, and the tuning shaft was insulated with a Johnson No. 252 rigid ceramic shaft coupling.

The final tank-coil assembly, a B & W HDVL, was mounted directly on the panel so that the coils plug in horizontally. This resulted in a saving of some height and gave short leads to the

◆

The safety kilowatt is completely self-contained in a large metal cabinet. The decks, from top to bottom, contain the push-pull final amplifier, switch panel, exciter unit and low-voltage power supply, modulator and modulation transformer, rectifiers and filter, and power transformers. Note the method of making all connections to power supply leads, which leaves no terminals unexposed. R.f. is carried from one section to another by flexible concentric line.

◆

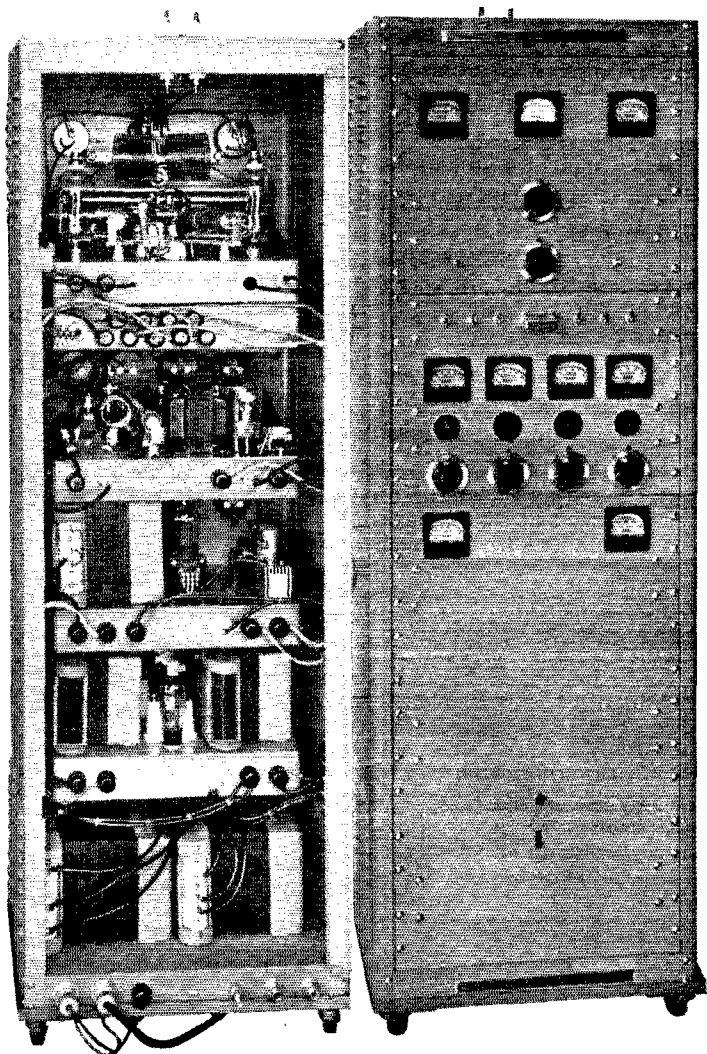

tank condenser. The neutralizing condensers, of the tubular type, were mounted horizontally in order to save lead length and to facilitate adjustment.

Another feature of the final amplifier is the provision for either individual or combined reading of the grid current. This was considered important because, although it is quite easy to have

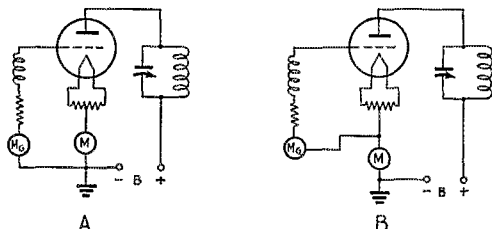

Fig. 1 — With the plate meter in the cathode circuit, it will read total cathode current if connected as at A. However, the grid current can be eliminated from the reading by connecting as at B. The latter method is used in the final amplifier being described.

sufficient total grid current, it is useful to know that the current is dividing equally between the two tubes. To prevent loss of bias during switching, 100-ohm one-watt resistors are connected from each grid return to the positive side of the meter. The resistors are in shunt with the grid-current meter but cause a negligible error because the meter resistance is less than one ohm. The grid circuit consists of a B & W coil assembly tuned by a Johnson 100DD20 condenser. The BVL coils are split in the center which makes it very simple to meter the grid currents individually as mentioned above. The amplifier as shown is extremely stable on all bands. It will not oscillate even when operated with bias low enough to allow considerable plate current to flow.

A one-turn link is very loosely coupled to the plate tank coil and terminates at the base of the cabinet, where it can be connected to an oscilloscope for observation of the wave pattern. One side is grounded, eliminating any danger of the operator coming in contact with the tank coil via the oscilloscope pick up.

### The Exciter Unit

The exciter consists of a T-21 oscillator, T-21 buffer-doubler, and a TZ-40 amplifier, and is band-switching from the front of the panel. Provision has been made for five crystals, one of which may be a variable type and adjustable from the panel. One of the five-prong sockets used for the crystals is connected so that a coil wound on a five-prong coil form with self-contained tuning condenser can be inserted and connected to an electron-coupled oscillator. This coil and condenser combination should be tuned to half the frequency of the crystal it replaces. This makes the oscillator act as a frequency doubler

If you have built or are building a high- or even medium-power job, you have probably run up against a few problems in design. This rig, designed primarily for safety, has some thoughts in it that are well worth passing along and may help you with your own troubles.

and eliminates the self-oscillation that would result from straight-through operation. The connections for this are shown in Fig. 2. All interstage coupling is capacitive, to facilitate band switching. The power supply for the two T-21 tubes is mounted on the same chassis and delivers 400 volts. The TZ-40 amplifier stage is connected as a balanced-output plate-neutralized amplifier and uses a B & W turret assembly in the output circuit. This allows the selection of three bands from the front of the panel. The plate voltage for the TZ-40 is obtained from the 1750-volt power supply primarily intended for the modulator. This voltage is reduced to the proper value by a series resistor and a cathode resistor. When the transmitter is being keyed the resting current of the high- $\mu$  TZ-40, with the bias secured from the cathode resistor, limits the plate dissipation to about 30 watts. This eliminates the need of a well-regulated bias supply in the transmitter, since the bias supply is needed only for the final amplifier. The TZ-40 operates with an r.f. choke in the plate and grid circuits and this caused the usual trouble of low-frequency parasitic oscillations. The plate choke becomes a low-frequency tank circuit and the grid choke allows sufficient

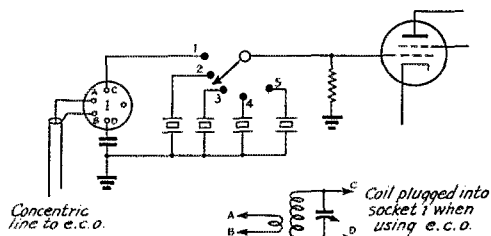
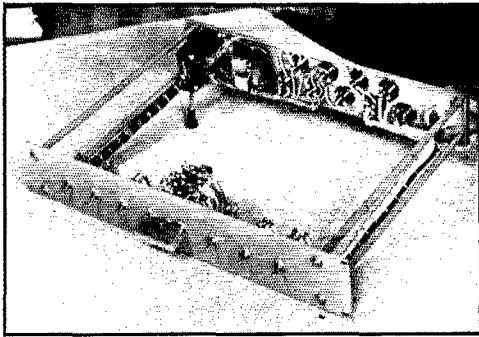

Fig. 2 — Either crystal control or e.c.o. can be used, by connecting one of the crystal sockets as shown. When the switch is in position 1, either a crystal can be used in the socket, or the coil and condenser can be plugged in and the excitation from the e.c.o. fed in through the concentric line. It is only necessary to tune the coil for the center of the band.

excitation voltage to build up and start a weak oscillation. This type of parasitic is only troublesome when the excitation is removed, as when keying, so the proper approach toward elimination was to make the plate choke look like a poor tank circuit and at the same time not effect the operation on the operating frequency. This was done by placing carbon one-watt resistors across



The switch panel unit includes all of the control switches except the high-low power switch for tuning. The metal block at the center of the panel is used to operate two toggle switches in the a.c. line simultaneously, since it was considered that one was not sufficient to handle the load. Three toggle switches handle local keying, 'phone or c.w. and plate on-off, while three others select the various plate supplies for tune-up purposes. A six-volt transformer to furnish current for the meter lights is mounted at the rear corner, next to the plate transformer relay.

the plate choke and gradually reducing the resistance until the oscillation stopped with the key open. 2000 ohms was found to be the proper value in our case. The rig is keyed by breaking both T-21 cathode circuits with a Guardian type K-100 relay. Six volts from the heater circuit is used to work the relay.

### Switch Panel

The switch panel is located between the exciter and the final amplifier. The 110 volts a.c. is brought from the door interlock switch to this unit and is distributed to all chassis in the proper sequence. Two Bud No. 1269 d.p.s.t. 10-ampere toggle switches, which must carry the total 20-ampere load of the transmitter, are located in the center of the panel. These switches are operated in tandem by means of a block of metal machined to join the two handles. Throwing this switch turns on all filaments and the meter lights. The three switches on the right are connected in the individual plate primaries so that any or all may be cut out during adjustment. Three switches on the left are used to change from telephone to telegraph, close the keying relay locally, and to operate the plate primary relay locally. Parallel connections of the latter two appear at the base of the transmitter for remote operation. All wiring in the switching unit terminates in nine four-prong Amphenol bakelite sockets and an Amphenol 92-C<sub>1</sub> receptacle. The plate primary

relay, a Guardian K-100, and the meter light transformer are also located in this unit.

### Modulator

Two 805's are used in the modulator. Experience has proven that they can modulate 1000 watts input very nicely if only voice is used and the plate-to-plate load made slightly lower than normal.<sup>2</sup> It was debated whether to install a bias regulator or use battery bias, and the battery won out because it was simple and only 22½ volts bias was necessary, with 1750 volts on the plates. Input to the modulator is through a 500-ohm line-to-grid transformer. The modulation transformer is connected in the negative lead instead of the conventional positive lead. This was done so that an inexpensive relay could be used to short-circuit the secondary when using c.w. This method requires only 3000-volt insulation instead of 6000. This method does, however, raise

(Continued on page 106)

<sup>2</sup> Anderson, "Speech Versus Sine Waves," *QST*, March, 1938.

Fig. 3 — Wiring diagram of the final amplifier.

- C<sub>1</sub> — 100- $\mu$ fd. per section (Johnson 100DD20).
- C<sub>2</sub> — 100- $\mu$ fd. per section (Johnson 100DD90).
- C<sub>3</sub>, C<sub>6</sub> — 0.002- $\mu$ fd., 1200-volt mica.
- C<sub>4</sub> — 0.002- $\mu$ fd., 12,500-volt mica (C-D 22A-86).
- C<sub>5</sub> — 0.01- $\mu$ fd. 600-volt paper.
- L<sub>1</sub>, L<sub>2</sub> — B & W BVL swinging-link assembly.
- L<sub>3</sub>, L<sub>4</sub> — B & W HDVL swinging-link assembly.
- M<sub>1</sub> — 0-150 ma.
- M<sub>2</sub> — 0-500 ma.
- M<sub>3</sub> — 0-5 ampere (Triplett No. 327A).
- NC — 0.375-inch spacing neutralizing condenser (Johnson N-375).
- R<sub>1</sub>, R<sub>2</sub> — 100-ohm 1-watt carbon.
- RFC — 500-Ma. r.f. choke (Johnson No. 754).
- S<sub>1</sub> — D.p.d.t. toggle switch.
- S<sub>2</sub> — S.p.d.t. toggle switch.
- A, B — Connectors (Amphenol PC1M) A is for excitation; B is for connection to oscilloscope.
- T<sub>1</sub> — 10-volt 8-ampere filament transformer (Stancor P6139).
- T.C. — Thermocouple for use with M<sub>3</sub>.

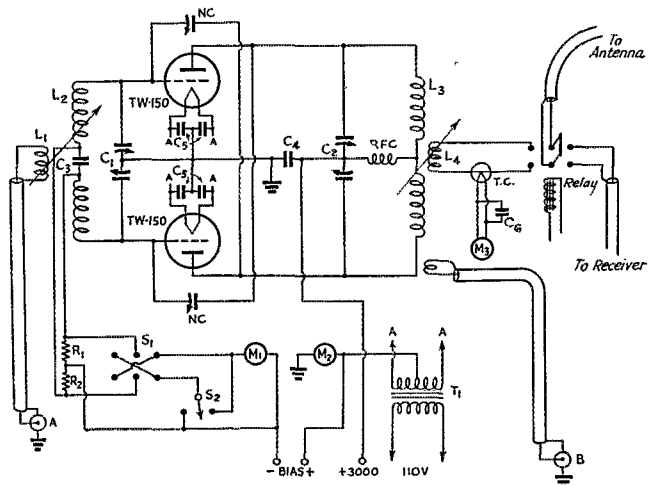

# Link Coupling for the Rotary Antenna

*A Three-Element Beam with Continuous Rotation in Either Direction*

BY J. M. BURKE, JR.,\* W5EME

AFTER discarding several different types of sliding contactors in an effort to make a 3-element rotary beam antenna completely rotatable, a system of link coupling was worked out which is simple to adjust and is giving splendid results.

From the accompanying photographs it can be seen that a tuned tank circuit is mounted just above the rotating mechanism and centered around the rotating shaft. For 20 meters this pancake-type coil, a thought carried over from the old spark days, has four turns of  $\frac{1}{4}$ -inch copper tubing spaced approximately  $\frac{3}{16}$  inch, with a mean diameter of  $10\frac{1}{4}$  inches. The 3-plate tuning condenser has a capacity of about  $15 \mu\text{fd.}$ , with 0.2-inch spacing between plates. This tank is fed with an ordinary 600-ohm untuned open-wire line, using slightly less than one turn of the antenna coil itself as the coupling link. The other end of the 600-ohm line is linked directly to the plate tank by one or two turns placed around it. This keeps the d.c. plate voltage off the transmission line. Tuning these two link-coupled tanks is quite conventional. The one-turn antenna coupling link ( $10\frac{1}{4}$  inches in diameter) is attached to but insulated from the rotator shaft and turns with the beam. As shown in the photograph, this link is spaced approximately  $\frac{3}{8}$  inch from the pancake coil.

A short coaxial cable is used to current feed the driver radiator of the 3-element beam from the one-turn link. The impedance at the center of the radiator element is quite low, amounting to some 10 or 15 ohms. The cable shown in the dia-

gram was constructed from two concentric tubes. The outer tube is  $\frac{3}{4}$ -inch thin-wall electrical conduit, measuring 0.82-inch inside diameter, and the inner tube is  $\frac{1}{2}$ -inch hard-drawn copper water pipe measuring 0.62 inch outside diameter.  $1\frac{1}{2}$  threaded studs are soldered to "center" in the shorter  $\frac{1}{2}$ -inch copper pipe and act as supports for the inner conductor. Johnson No. 45 feed-through insulators were used to insulate and space the tubes, using the short end with the glazed-porcelain cone tip. The gaskets supplied with the

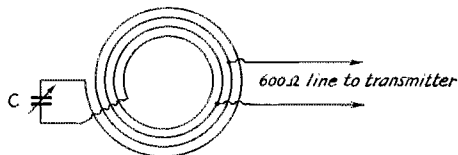
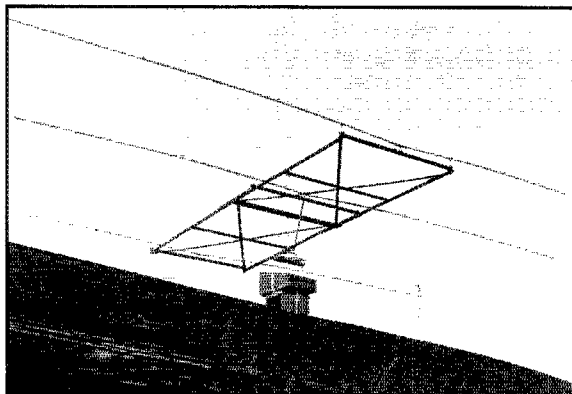

Fig. 1—The 600-ohm line from the transmitter is tapped on to one turn of a 4-turn tank coil which is tuned by condenser C. A one-turn pick-up coil is inductively coupled to the four-turn coil and feeds the antenna through a short section of coaxial line.

insulators were shellacked in place to keep out moisture and to keep the tube spacing correct. This cable has  $1/10$ -inch air spacing and a much longer glazed porcelain insulation path. The energy transfer is good, with no noticeable heating at the 500 watts input used. The impedance figures to be about 16 ohms from the formula, which is a fair match for the low-impedance radiator.

The 3-element beam uses tenth-wavelength spacing for the reflector and 0.15-wavelength spacing for the director, as recommended in the

\* 1315 South College St., Tyler, Texas.



The continuously-rotatable three-element beam mounted on the rooftop, with part of the weatherproof housing removed to show the inductive-coupling system.



Here is a straightforward solution to that bugaboo of rotary antennas: the feed problem. Inductive coupling, a simple reversible drive, and an easy-to-build direction indicator make this a worth-while article for the 99% interested in rotatable antennas. The other 1% can learn something, too.

A close-up of the drive gear reveals the direction-indicator switch under the gear. ➡➡

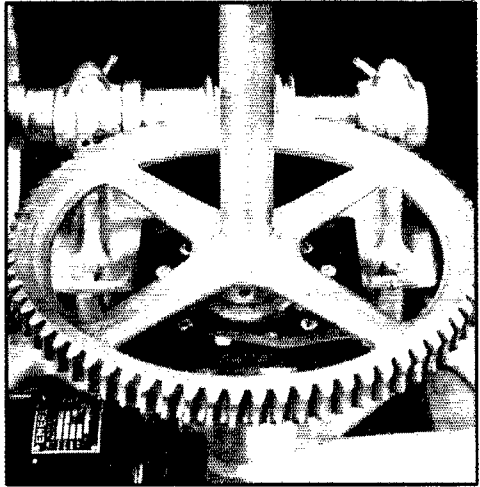

Premax Technical Bulletin H-3. Tuning of such a beam has been thoroughly covered in previous articles, and needs no further comment.

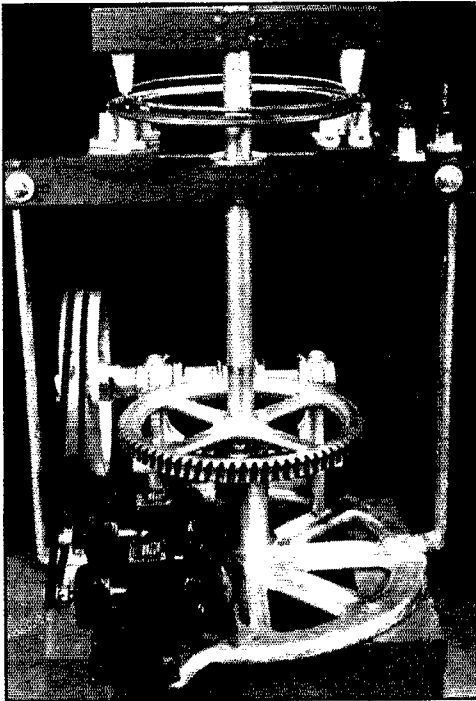

The antenna coil, its tuning condenser, and the one-turn pick-up loop can be seen at the top of the photograph. The gear drive for the shaft is shown at the bottom, belt-driven by two motors which allow rotation in either direction. In use, the whole unit is covered by a weatherproof housing.

### Direction Indicator

The direction indicator uses an A.R.R.L. radio map of the world, mounted on  $\frac{1}{4}$ -inch plywood with picture molding around it. Tyler, Texas, was located on the map, and a pin-hole made through into the plywood. The map was removed and a 16-inch circle drawn with this point as the center. Twelve points were located on the circle corresponding to the hour markings on the face of a clock, with 12 o'clock pointing due north. Holes were drilled at all these points to take 6.3-volt dial lights. The map was remounted and dial lights were inserted from the rear so as just to touch but not break the map paper. Red lines were then drawn on the map from the center (Tyler) through each light to the edge of the map. The lights are connected through a small filament transformer, and a 12-wire cable was run to the contactor on the rotor mechanism. The photograph shows the details of the contactor. The phosphor-bronze contactor bridges between contacts as it passes around, so that either one or two lights are always burning. This gives 12 single direction points on the map, and 12 additional

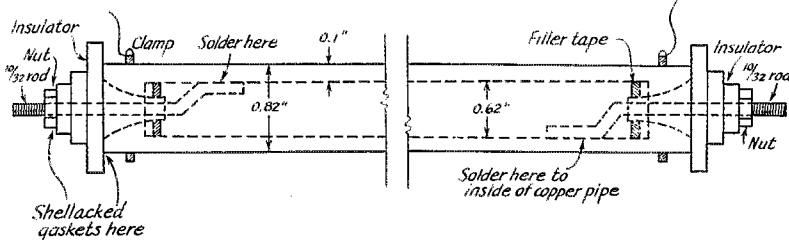

Fig. 2 — The coaxial line from the pick-up coil to the antenna is made of thin-wall electrical conduit with a piece of  $\frac{1}{2}$ -inch copper tubing running through the center. Parts of feed-through insulators support the inner conductor, and the line is made weatherproof by sealing at both ends.

intermediate points when any two lights are burning. The dial lights shining through the map paper give a soft and pleasing effect.

The rotor mechanism uses two  $\frac{1}{2}$ 0-hp. Emerson motors arranged so that the beam is reversible and continuously rotatable from the operating table. A grounded metal cover protects the mechanism from the weather.

#### Adjustment

Standing waves on the 600-ohm line were reduced to a near minimum by adjusting the coupling turns on each end of the line. A few inches of wire and a flashlight bulb were used as an indicator. The coupling was adjusted between the coil and the one-turn link (this link is located above the antenna coil and connects to the coaxial cable) until correct final amplifier loading was obtained. Naturally, there is some interlock, and it is necessary to tune first one and then the other. It is also well to choose a length of line which is not resonant at or near the frequency used.

Results have been very satisfactory both in transmitting and receiving, and many excellent reports have been obtained. Although tuned for the middle of the 14-Mc. 'phone band, it seems to work well from one end of the phone band to the other.

Photographs are by J. Heath Lamb, W5PH.

## New Method of Rating Transmitting Tubes

**E**VERYBODY knows that a tube doesn't immediately blow up when it's pushed a bit beyond the manufacturer's ratings, but the tantalizing question is: Just how far can the pushing be carried on? And, supposing the life is shortened thereby, how much more power can be taken from the tube before it becomes cheaper to buy the next larger tube rather than overload the small one?

A new system of dual ratings introduced by RCA Manufacturing Company, taking into account the difference between the kind of operating done by amateurs and that in commercial work, should help to answer some of these questions. We quote from a statement on the subject:

"Instead of one set of maximum ratings for each tube type, two sets of maximum ratings are given. These ratings are designated 'continuous commercial service' (CCS) and 'intermittent commercial and amateur service' (ICAS). The CCS ratings are essentially the same as the former maximum ratings. The ICAS ratings, however, are considerably higher, permit the use of much greater power input, and provide a relatively

(Continued on page 98)

---

## Clyde Gardner, W6KOT

**C**LYDE GARDNER, owner and operator of amateur radio station W6KOT at 1178 Esperanza Street, Los Angeles, Calif., passed away on Friday, September 22nd, at around midnight. From all indications he did not "Switch to Safety." The facts are obscured due to the fire, but I will try to give all the information available. At about 10:30 p.m. on Friday night, Clyde left the house telling the folks he was going out to the shack to see who he could work on his new rig. He had recently rebuilt it to high power. He was always joking about his going high power. This time, according to all reports, he was running about 27 watts to a 6L6 final on 160 'phone and 40 c.w. He had a typical ham shack in a part of his garage with cement floor, no safety switches, one door with a Yale spring lock, and one window. The door and window were both closed. About midnight, his sister-in-law saw the garage on fire. She rushed out to investigate and found the door locked from the inside by the spring lock. She then called the fire department. They arrived in time to save the surrounding buildings, but when they broke into the ham shack there was Clyde Gardner, lying on his back, his feet pointing toward the transmitter as though he had fallen away from it. There was no indication of electrical shock due to the condition of the body, third degree burns all over it. However, it does not seem possible that Clyde could have died by the fire alone. It is more likely that he received a shock which may have caused him to lose consciousness. Or he could have received a shock strong enough to cause him to fall on his back and strike his head on the cement floor. There he lay, while the fire, which started from an unknown source in the vicinity of the shack, consumed his body. All evidence was destroyed in the flames.

One report claims he was found with the headphones still on his head, but no confirmation of this detail could be had. The highest voltage around was 1000-volt a.c. before it went to the rectifier. Summing it up, everything points to these facts: Clyde received a shock, caused a short circuit in the power lines which resulted in the fire, and fell to the floor unconscious. His sister-in-law was unable to get to him due to the lock on the door and window—so in your "Switch to Safety" campaign add spring locks to the taboo list.

Clyde Gardner was 29 years old and unmarried. He had been active ever since he received his ticket in 1934.

— Ralph Click, W6MQM, S.C.M.

---

# A New Method of Measuring A.C. Voltages

*Applying the Cathode-Ray Oscilloscope to the Slide-Back Voltmeter*

BY GEORGE S. WACHTMAN\*

**T**HIS is an account of a method of measuring a.c. voltages with cathode-ray tubes of the electrostatic-deflection, medium- or short-persistence screen, type, with descriptions of the equipment needed and used in the experiments pertaining to the development of the method.

### Theoretical Considerations

Considering a cathode-ray tube of the type described above, with the various electrode voltages adjusted to give a sharply defined spot on the screen and one vertical and two horizontal deflecting plates grounded; suppose a positive potential of 100 volts with respect to ground is applied to the free vertical deflecting plate as at *A*, Fig. 1. The spot will move up vertically away from its normal position near the center of the screen a distance proportional to the voltage applied to the plate.

Now, if a negative potential with respect to ground of 100 volts is applied in series with the positive potential and ground as at *B*, Fig. 1, so that the two voltages oppose one another, the spot will immediately move back to its exact original position. Therefore, the voltage necessary to deflect the spot back to its original position may be taken as an exact measure of the voltage necessary to move it away. This applies to either set of plates, of course.

It should be possible, theoretically, to measure the spot's distance at any point on the screen from its normal position in terms of the voltage necessary to deflect it back to this position. Practically, this is true except when the spot's position is indistinguishable from its position at any other point on the screen, such as in the case of a solid pattern or when the image or signal is of an irregularly recurrent or transient nature.

In case one or more a.c. voltages may be applied to either or both sets of plates, either separately or simultaneously, the important thing to

\*2737 Boas Street, Penbrook, Harrisburg, Pa.

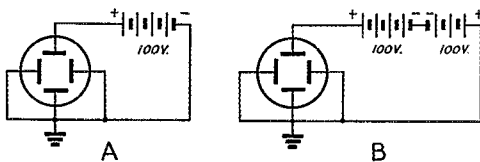

Fig. 1 — Simplified diagram of a cathode-ray oscilloscope tube as used in the slide-back voltmeter.

remember is that any image that appears on the screen is caused by a more or less rapidly moving spot which, because of the persistence of vision of the eye, is caused to appear as a single image instead of a moving spot. Thus any point on any pattern appearing on the screen may be considered as a single spot which may be measured as before stated. If a linear-time base is used to sweep the spot along one axis, the voltage/time relation may be determined.

### Equipment Needed

Three things are apparently necessary to make even the most rudimentary measurements by this method: First, of course, a cathode-ray oscilloscope of some sort or other; second, a source of variable d.c. voltage with which to bias or return



Fig. 2 — The set-up used in making the measurements. The oscilloscope on the left is connected to the d.c. voltmeter at the right by two flexible leads. Reading from left to right on the voltmeter, the controls are: range switch, r.m.s. toggle switch, and the potentiometer which controls the d.c. output.

the spot to normal or some other reference point; and third, a d.c. voltmeter with which to measure the variable d.c. voltage.

The oscilloscope may be of any type employing a cathode-ray tube of the electrostatic type, from the simplest composed of the CR tube and its associated power supply to the most elaborate with its amplifiers and linear sweep, according to the kind of signal to be measured and the amount of information to be gleaned from it. However, there must be some means provided whereby a variable d.c. voltage can be connected in series with the free deflecting plate to which the signal

If you own an oscilloscope and a half-way decent d.c. voltmeter, there's no reason why you can't measure a.c. voltages within normal ranges. The method described here gives you more accuracy than you could normally obtain.

to be measured is applied, usually the vertical one. Also, a transparent screen with at least two lines ruled on it at right angles to each other across the center is essential. This screen is placed in front of the tube's screen and the lines used as reference when biasing the spot during a measurement. It should be mounted so that one of the ruled lines is parallel to the horizontal or "X" axis of the tube, or the line drawn by the spot when it is deflected horizontally. The other line should then be parallel to the vertical or "Y" axis of the tube. Usually it is simply a matter of mounting the screen centrally before the tube and then rotating the tube until its axes and the screen's lines coincide. In some cases it is impossible to place the screen and the tube so that both lines are parallel to the axes of the tube, and in such a case it is best to place them so that the horizontal line and the horizontal axis coincide as most of the voltage measurements are made with the horizontal line as a reference. The vertical line is used in determining the voltage-time relation of a signal.

The source of variable d.c. voltage can be anything that is capable of delivering enough voltage to deflect the spot from one edge to the center (or vice versa) of the tube used, at a current of from 5 to 10 milliamperes and with very little ripple (1% or less). A potentiometer is used to vary the voltage. In some cases the centering controls on the oscillograph will serve as the source of variable d.c., provided there is enough range of voltage. In any case the output should be variable from zero up to as high as necessary.

Almost any good d.c. voltmeter with suitable ranges will serve as the measuring instrument. That is, one that is sensitive enough not to overload the variable attenuating control on the d.c. source.

Various combinations of these three units may be used. They can be combined in one unit or may be separate; other combinations may be used to suit individual needs. Obviously the single unit is to be preferred.

### Equipment Used in Experiments

The equipment used in developing this method of measuring a.c. voltages was all straightforward. Fig. 2 shows the oscillograph and d.c. voltmeter set up to make a measurement.

The CRO is a home-built affair employing a 913 CR tube. It is self-contained, having its

power supply, linear-time base, vertical amplifier, and CR tube contained in one unit. Its unusual feature is the shorting-type 'phone tip jack through which a variable d.c. voltage may be applied in series with the free vertical deflecting plate of the 913 and the vertical centering control. Fig. 3 is a schematic diagram of this feature. This same means of inserting a d.c. voltage may be used with the horizontal plates.

The 1- to 2-megohm resistor,  $R_2$ , connected across the 'phone tip jack, is to keep the circuit

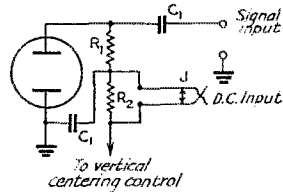

Fig. 3 — Schematic diagram of the input to the CRO.  
 $C_1$  — 0.25  $\mu$ fd., 600-volt paper.  
 $C_2$  — 0.5- $\mu$ fd., 600-volt paper.  
 $R_1$  — 1 megohm,  $\frac{1}{2}$ -watt.  
 $R_2$  — 1 to 2 megohms,  $\frac{1}{2}$ -watt.  
 $J$  — Shorting-type 'phone jack.

continuous from centering control to plate when the jack is opened and in no way affects the accuracy of a measurement. The 0.5- $\mu$ fd. condenser,  $C_2$ , is necessary to by-pass any ripple that may appear in the circuit.

The d.c. measuring equipment is an 0-1-ma. meter. There are five ranges available through a selector switch. The ranges used in conjunction with the CRO and power supply are: (1) 100-volts peak, and through an auxiliary s.p.s.t. toggle switch, 100-volt r.m.s. direct-reading range; and (2) a 250-volt peak indirect reading range; i.e., on range 2 the scale of the milliammeter must be multiplied by 2.5 and the product taken as the voltage indicated by the instrument. This latter range is used only in making peak measurements between 100 and 150 volts.

A 4-prong tube socket is mounted on the back of the instrument case into which the cable outlet from a portable power supply is plugged when measurements are to be made. The output of the power supply is fed from this socket through an attenuating network which includes the potentiometer, the control knob of which may be seen in right center of the panel of the instrument. The variable d.c. output is taken from the negative end and the movable arm of the potentiometer. It is fed directly across these jacks through appropriate series dropping resistors on each of the two ranges by means of the range switch. Fig. 4 is a schematic diagram of the circuit showing the various parts of the instrument used in these two ranges, including the attenuating network and socket.

$Sw_2$  and  $R_4$  are used only when reading r.m.s.

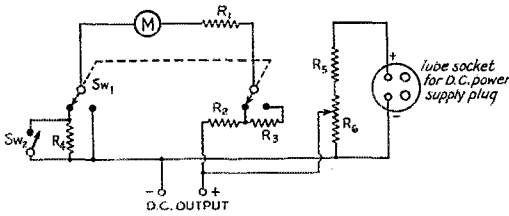

Fig. 4 — Circuit of the d.c. voltmeter.

- R<sub>1</sub> — 267 ohms.
- R<sub>2</sub> — 99,700 ohms.
- R<sub>3</sub> — 1,500,000 ohms.
- R<sub>4</sub> — 41,400 ohms.
- R<sub>5</sub> — 50,000 ohms, 1-watt.
- R<sub>6</sub> — 50,000-ohm potentiometer (CRL, No. 1 taper).
- M — 0-1 milliammeter. Resistance of 33 ohms.
- R<sub>1</sub>, R<sub>2</sub>, R<sub>3</sub> and R<sub>4</sub> are adjusted to 1%.

voltages of signals whose waveforms are sine- or very near sine-wave in character. Referring to Fig. 4, with *Sw*<sub>1</sub> in position 1 and *Sw*<sub>2</sub> closed, the meter is connected through a 99,700-ohm resistor, *R*<sub>2</sub>, to the variable d.c. output jacks and reads directly the d.c. equivalent of the peak voltage of the signal. With *Sw*<sub>2</sub> open, a 41,400-ohm resistor, *R*<sub>4</sub>, is connected in series with the negative lead to the meter, and the meter reads directly the d.c. equivalent of the r.m.s. value of the signal. Because of this resistor the meter actually reads 70.7% of the voltage across the output terminals. For a full-scale deflection of 1 ma., 141.4 volts must be applied to the terminals; i.e., the output voltage is actually 1.414 times that indicated by the voltmeter, or the voltmeter indicates 0.707 of the voltage over the terminals, thus indicating the r.m.s. value directly in volts.

It is readily seen why this is so. Suppose we have a symmetrical sine-wave signal on the screen whose r.m.s. value is known to be 100 volts. Its peak value is, therefore, 1.414 times this value, or 141.4 volts. As it will take 141.4 volts d.c. to bias the upper tip of the image down to the upper edge of the reference line, and the meter reads 0.707 of the variable d.c. output from the d.c. source with *Sw*<sub>2</sub> open, then  $0.707 \times 141.4 = 100$  volts, the d.c. equivalent of the r.m.s. value. Biasing and adjustment of the image is explained later.

The d.c. source or power supply furnishes about 375 volts at 50 ma. Nothing further need be said about it except that it is quite well filtered; in all other respects it is similar to any other a.c. power supply.

### Practical Considerations

We shall now consider the practical aspects of making measurements. After the CRO has been turned on and allowed to warm up for a minute or so, the first adjustment is to focus the spot on the screen. Too much care cannot be exercised in doing this — the spot should have a very definite sharp outline when properly focused. The size of

the spot is immaterial so long as it is properly focused and only peak measurements are being taken. If measurements other than peak (those involving details of a signal) are to be made, the spot should be as small as practical yet bright enough to be seen without too much eye-strain. If a horizontal sweep, either linear or otherwise, is to be used, the sweep should be applied and the line caused by the spot should be adjusted until it is of uniform width, and its upper and lower edges are sharply defined throughout its length.

Since when the spot is deflected horizontally, the spot or line has a finite width, it must be displaced enough to bring one of its edges even with one of the edges of the horizontal reference line on the transparent screen; upper edge even with upper edge, as at *A*, Fig. 5, if measuring the upper half, and lower edge even with lower edge, as at *B*, Fig. 5, if measuring the lower half of a signal as seen on the screen of the CR tube. This adjustment minimizes one of the chief sources of error. The necessary displacement of the spot or line is brought about by varying the vertical centering control by the correct amount.

This brings us to another point in question: whether to measure the positive or negative half of a signal. (The portions of the CR tube's screen in which the positive and negative halves of an image appear may be determined by applying a positive d.c. voltage to the free vertical deflecting plate and noting which half of the screen the spot is deflected into, in which case any portion of any image appearing in that half is positive and any portion appearing in the other is negative. In this case the horizontal reference line is used as the dividing line.) It is immaterial which half of a symmetrical signal is measured — either one will do — but the decision as to which half of an asymmetrical signal should be measured lies entirely with the operator and his judgment and depends on the requirements of the case.

The most important part of all entails the biasing of the spot or image. For example, suppose we want to measure the peak voltage of the upper half of an image or respective half of a signal. This may be done either with or without horizontal deflection of the spot. After the spot has been focused properly and adjusted as described before and the spot or line is adjusted upper edge to upper edge of the reference line,

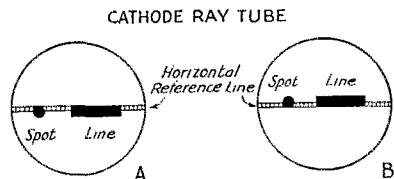

Fig. 5 — Showing how the adjustment of the spot or line depends on whether the voltage is to be measured above or below the reference.

the signal is applied to the vertical plates, the voltmeter connected to the output of the d.c. power supply and the variable d.c. output connected to the shorting type 'phone tip jacks on the CRO. Now all that is necessary is to adjust the bias until the very upper tip of the line or image that appears on the screen is even with the upper edge of the horizontal reference line. This is done by adjusting the potentiometer on the instrument panel of the voltmeter; i.e., by varying the output of the d.c. supply, and then noting the voltage indicated by the voltmeter. This reading is equal to the peak voltage of the upper half of the image or the respective half of the signal. In case the image moves up instead of down when adjusting the potentiometer, reverse the leads connecting the variable d.c. voltage to the CRO.

The same procedure is carried out in reverse when measuring the peak voltage of any part of any image appearing in the lower half of the screen, i.e., the lower edge of the spot or line is adjusted until it is even with the lower edge of the reference line, and the signal is applied and biased until the very lower tip is again even with the lower edge of the reference line. The voltage can then be read from the voltmeter. Fig. 6 illus-

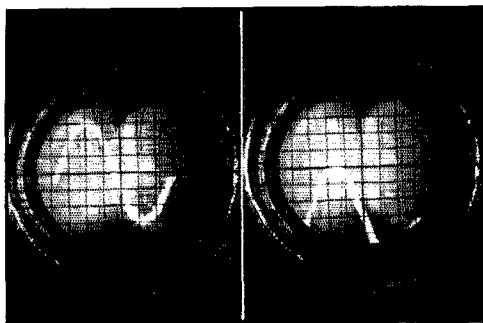

Fig. 6 — Normal position (A) of image just prior to making a measurement, and (B) image adjusted to measure peak voltage of upper half.

trates the various positions of the image, including its normal or unbiased position, when properly biased for peak measurements.

### Time Relations

To locate the spot's relation to time simply means to determine its position with respect to the beginning of a cycle, in electrical-time degrees. This may be done easily if a linear time-base is used to sweep the spot along the horizontal axis, the horizontal and vertical reference lines are parallel to the X and Y axes respectively, and a means is provided whereby a variable d.c. voltage can be applied in series with the plates to which the linear sweep voltage is applied. For example; if the conditions outlined above are

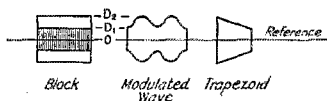

Fig. 7 — Illustrating the points measured for determining the percentage of modulation. The three usual types of images are shown.

met, it is then necessary to apply the linear-sweep voltage to the horizontal plates and make its amplitude as great as is consistent with good linearity. Next, the horizontal line created by the moving spot should be adjusted to the horizontal reference line as in taking a measurement of the peak voltage of a signal. The signal is then applied to the vertical plates and the sweep frequency adjusted until two or three cycles appear on the screen of the tube. After choosing one of the cycles to measure, the point at which it begins (i.e., one of the points at which the spot crosses the zero or horizontal reference line) is adjusted to the junction of the horizontal and vertical reference lines by means of the horizontal centering control and the variable d.c. voltage supply is connected in series with the horizontal deflecting plate and centering control of the CRO.

The tube is then biased until the end of the cycle,  $P_1$ , is at the same position on the screen as the beginning was before. The voltage indicated by the voltmeter,  $V_1$ , is noted. The point on the curve of the cycle whose position in electrical-time degrees is to be found,  $P_2$ , is selected, and the d.c. voltage on the horizontal plate is again varied until this point is even with the vertical reference line. The voltage,  $V_2$ , is read from the voltmeter and noted. The position of  $P_2$  in electrical-time degrees is found by:

$$P_2^\circ = \frac{V_2}{V_1} \times 360$$

To measure a point on the slope of a curve a linear time base should be used, the point adjusted to the vertical reference line, and then biased up or down to obtain the voltage.

### Percentage of Modulation

To measure the percentage of modulation of an r.f. signal it is only necessary to follow the same general procedure for focusing and adjusting the spot or line as before and then measuring the voltages represented by 0 to  $D_1$ , and 0 to  $D_2$ , Fig. 7, by biasing  $D_1$  and  $D_2$  down to the horizontal reference line respectively. The percentage of modulation is then found by substituting in the equation:

$$\% \text{ Mod.} = \frac{D_2 - D_1}{D_2 + D_1} \times 100$$

A word about the accuracy attainable with this method of measurement. The accuracy of adjustment of the spot or line to the reference line may

be held within less than 1/100 inch or 1% of the diameter of the 913's screen. This figure may vary with different persons as it depends somewhat on the operator's eyes. In my own case, I have found my error in adjustment to be approximately 0.008 inch or 0.8% of the diameter of the screen. When measuring a signal of 100 peak volts this would be equal to an error of approximately 1.6%, as the measurement is made from one peak to the reference line at the center of the screen.<sup>1</sup>

This is well within the 2% full-scale error which is the maximum guaranteed for the meter used as the indicating device in this case. The error in adjustment in per cent of signal is approximately inversely proportional to the size of the image or amplitude of the signal; for instance, if there is an initial error of 1.6% at 100 volts, this will rise to 2.5% at 50 volts, 5.25% at 20 volts, and approximately 10% at 10 volts. Therefore, the larger the amplitude of the signal the less the error of the measurement. As for the error due to the meter, this may be minimized by using a more accurate meter or by adding additional low voltage ranges, say 50-volt and 25-volt ranges, or both. On measurements below 10 volts the error of adjustment becomes too great to make such measurements practical.

As the impedance of  $C_1$ , Fig. 3, varies with frequency it will introduce an appreciable error when measurements are made on the lower frequencies. The impedance of this condenser equals 5,400 ohms at 120 cycles, 10,800 ohms at 60 cycles, and 21,600 ohms at 30 cycles, introducing errors of -0.5%, -1.0%, and -2.0%, respectively.

There is one precaution to be observed when setting up the equipment to make a measurement, and that is to make certain that there is no direct connection between the CRO and the d.c. power supply other than the two connections to the 'phone jack in series with the free vertical deflecting plate and the vertical centering control. For instance, if the CRO chassis were directly connected to the negative side of the power supply while the two leads to the 'phone jack were connected, the centering voltage from the vertical centering control would be shorted to ground and the control would cease to function as such. In any case, whether the bias or d.c. source and the CRO are combined in one unit or are separate, they should be isolated from each other *except* for the two leads or connections in series with the free plate of the CR tube.

The voltage limits of the tube, a 913, may be extended by an attenuating network of the parallel element type in case voltages in excess of 150 volts peak are to be measured, and by amplifiers in case voltages lower than 10 volts are to be

measured. When an amplifier is used it is necessary either to calibrate it or use it as a vacuum tube voltmeter. In the latter case the CR tube is used merely to indicate false zero.

Heretofore when measuring voltages with a CR tube it was necessary to know its deflection sensitivity, whereas it has very little effect on the accuracy and need not be known when using the method just described. There are several other advantages to the use of this method, chief among which is the greater accuracy than that obtained by using the older one of calibrating the screen of the CR tube in volts/inch or volts/mm. deflection. Once this system is mastered it is very easy to take measurements of almost any type of signal.

## U.H.F. Contest and Relay— November 4th-5th

**T**HE September relay was acclaimed. The gang asked for another. Here it is. And don't think we're not going on to have more fun. Five-meters, and 2½- are year 'round bands. A surprisingly large number of operators have u.h.f. gear alongside low frequency transmitters and are just looking for chances to test it out. Here's our chance!

**Scoring Contacts:** List all different stations worked in the contest period, which is November 4th (Saturday), 3 P.M. local time, to November 5th (Sunday), 11.59 P.M. local time. Beside the calls show the *location* of these stations, obtained as you work them, for points claimed. For stations

Under 50 miles, score 1 point  
50 up to 100 miles, score 2 points  
100 up to 300 miles, score 5 points  
Over 300 miles, score 10 points

For originating and sending a five-to-ten word test message, specifically addressed to remote sections of the country, as in September (one message only may be started per station) and mailing copy, *with handling data* to Hq., 10 additional points may be credited. Likewise, for relaying such messages away from the starting point and submitting copies, count 3 points each, *1 for receiving by radio, 2 for each relay onward*. Operators subject to the difficulties and inconveniences of working at field locations under portable designation, may multiply the sum of their contact and relaying scores by *two*.

**U.H.F. Certificate Award:** Each participant who sends a "station worked" list, with message copies attached, and a claimed score, will receive a special A.R.R.L. certificate showing his score and how many stations were worked, in this activity. It's a neat certificate that will be valued as

(Continued on page 118)

<sup>1</sup> Since writing this story, Mr. Wachtman has found that the accuracy can be increased by using a larger tube. A 906 with 1000 volts on the number 2 anode gives only one-third the error of the 913. — Ed.

# The Portable at W7AW

*A Complete Low-Power 'Phone and C.W. Rig*

BY I. VEE IVERSEN,\* W7AW

**T**HIS transmitter is the result of several years of operating portable transmitters of various kinds. I have tried to discard all of the undesirable features and retain only the good ones in the rig to be described.

Since I work portable a good portion of the time and have learned about what minimum power I can use and still get satisfactory results, I designed this transmitter by starting with the final stage and working backwards to the oscil-

## The Circuit

An RCA 809 was selected for the output tube and, since this tube is not too easy to drive, I decided to use an 802 as a Tri-tet oscillator-buffer for c.w. operation. Using 7-Mc. crystals and doubling to 14 Mc. in the plate circuit, the 802 Tri-tet drives 20 mils grid current through the 3000-ohm grid leak of the 809.

I wished to have the final tank single-ended, to

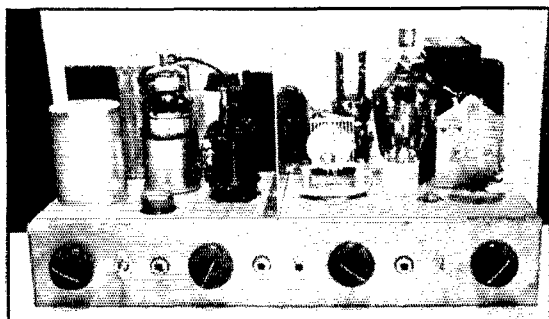

A general view of the r.f. section shows the power supply along the rear of the chassis and the r.f. portion along the front. The r.f. components, from left to right, are cathode coil (under shield), crystal and 802 oscillator, 802 plate tank coil, interstage shield, 809 grid coil and 809 plate coil. The controls and jacks along the front, from left to right, are cathode condenser, line switch, key jack, oscillator tank condenser, oscillator plate-current jack, 809 grid-current jack, 809 grid condenser, 809 plate-current jack, plate-voltage switch and 809 plate tank condenser.

lator. I knew from experience that 14 Mc. was the best band for my operation because of antenna limitations and past experience with the other bands. For an antenna I selected a half-wave center-fed horizontal radiator made of fixture wire (the flexible kind used for wiring home-lighting fixtures), so that it can be put up and taken down with the least trouble. For feed line I use the twisted-pair transmission line sold for use with b.c.l. all-wave antennas and, in spite of its reputation, I have never had any of this line break down from voltage or other causes, and some of it has been used for over two years in all kinds of weather. The antenna and transmission line are coiled up together when not in use.

I found the best dimensions for the "Y" match from the transmission line to the flat top to be 20 inches on each side of the triangle, for 14-Mc. operation. My antenna is seldom over 10 to 15 feet above the ground, but it gets out in good style, if the results obtained in operation are any indication.

\*Office of Chief Engineer, Northern Pacific Railway, St. Paul, Minn.

make it simpler to feed the twisted pair transmission line to the antenna, and this made grid neutralization necessary. I used one mesh of a pi network for combined final tank circuit and antenna feed, the condenser feeding the transmission line to the antenna being a fixed one. As I



A view underneath the chassis of the r.f. unit shows the location of the components. Note the plug-in antenna-coupling condenser,  $C_{25}$ , on the right-hand side just below the plate tank condenser.



It takes more than spending most of his time away from home to reduce an old-timer's interest in amateur radio. This is the story of a portable for the traveler who has 110 volts a.c. available at his stops but not much else.

use the same antenna and run the 809 to full load all the time, the fixed capacity works out nicely and takes up less space than a variable. The harmonics seem to be attenuated greatly with this coupling network. The coupling condenser is mounted on GR banana plugs, so that it may be changed quickly or a variable condenser used. It may be shorted out if a coupling link is used or if some other type of antenna becomes available. In my case, to load the 809 to 100 mills this condenser is made up of five 0.00015  $\mu$ fd. 5000-volt mica condensers in parallel. These condensers are operated in parallel to allow for the heavy circulating current they have to carry.

The grid and plate coils for the 809 are Decker coils that plug into five-prong sockets. The plate coil of the 802 is link-coupled to the grid coil of the 809, using nine turns for link coupling to the 802 and one turn on the grid coil of the 809, to

give the greatest transfer of power. The plate coil of the 802 is a tapped coil wound on a five-prong plug-in coil form, wound ten turns to the inch and wound full. The tuning condenser should be tapped at about the center of the coil, just so the coil can be tuned. This gives the necessary high-impedance load for the 802 and increases the output of the tube considerably over what can be taken from a tank circuit that has the condenser across the whole coil. The cathode tank for a 7-Mc. crystal is 7 turns on a 1½-inch form.

Blocked-grid keying is used, the blocking voltage being taken from the power supply and, with the values of capacity and resistance used, all key clicks are eliminated. With 550 volts on the plate of the 802, a blocking voltage of 250 volts on the grid is necessary to cut off the plate current.

Since it is a high- $\mu$  tube no provision is made for blocking the grid of the 809 and, with excitation removed and full plate voltage applied, it draws only 20 mills, which will not harm the tube during periods of no excitation. All bias for the 809 is from the grid leak.

A switch is placed in the negative lead from the center tap of the power transformer secondary to ground, to cut the plate voltage to the tubes and still allow the filament of the 5Z3 to be heated. This method allows the use of a single-pole

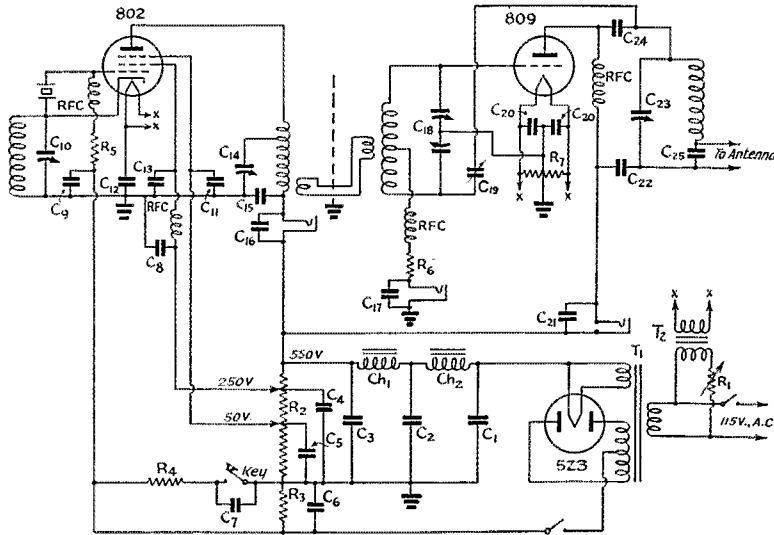

Fig. 1—Circuit diagram of the transmitter as used for c.w.

- C<sub>1</sub>—0.1- $\mu$ fd., 1200-volt.
- C<sub>2</sub>, C<sub>3</sub>—4- $\mu$ fd., 1000-volt.
- C<sub>4</sub>—24- $\mu$ fd. electrolytic, 450-volt.
- C<sub>5</sub>—10- $\mu$ fd. electrolytic, 250-volt.
- C<sub>6</sub>—3- $\mu$ fd., 400-volt.
- C<sub>7</sub>—0.1- $\mu$ fd., 400-volt.
- C<sub>8</sub>, C<sub>9</sub>, C<sub>11</sub>, C<sub>12</sub>, C<sub>13</sub>, C<sub>16</sub>, C<sub>17</sub>, C<sub>21</sub>—0.001- $\mu$ fd. mica.
- C<sub>10</sub>—100- $\mu$ fd. variable.
- C<sub>14</sub>, C<sub>23</sub>—50- $\mu$ fd. variable.
- C<sub>15</sub>—0.002- $\mu$ fd., 1000-volt mica.
- C<sub>18</sub>—50- $\mu$ fd. each section split-

- stator.
- C<sub>19</sub>—10- $\mu$ fd. neutralizing condenser.
- C<sub>20</sub>—0.006- $\mu$ fd., 600-volt.
- C<sub>22</sub>—0.001- $\mu$ fd., 5000-volt.
- C<sub>24</sub>—0.006- $\mu$ fd., 5000-volt.
- C<sub>25</sub>—Five 0.00015- $\mu$ fd., 5000-volt mica in parallel.
- Ch<sub>1</sub>—20-henry choke.
- Ch<sub>2</sub>—5-henry choke.
- R<sub>1</sub>—100-ohm wire-wound filament rheostat.

- R<sub>2</sub>—50,000-ohm, 50-watt voltage divider.
- R<sub>3</sub>—10,000-ohm, 10-watt.
- R<sub>4</sub>—40- to 100-ohm, 5-watt.
- R<sub>5</sub>—20,000-ohm, 2-watt.
- R<sub>6</sub>—3,000-ohm, 10-watt.
- R<sub>7</sub>—60-ohm center-tapped, to carry 100 ma.
- T<sub>1</sub>—Plate transformer, 600-0-600 at 170 ma.
- T<sub>2</sub>—7½-volt filament transformer.

single-throw switch of the small toggle variety to be used to cut plate voltage. I feel it is much safer than using a double-pole switch to break the plate leads to the rectifier tube, as is sometimes done. The latter method puts a high voltage across the switch—in fact, twice that which will appear across the switch insulation as I have used it.

Due to the large variation in line voltage found in various parts of the country, I have used a 7.5-volt filament transformer with a rheostat in the primary, to allow me to have 6.3 volts for the 809 and the 802, even under very low supply-voltage conditions.

I found that by putting 24  $\mu\text{fd.}$  of electrolytic condenser across the supply tap for the screen of the 802 Tri-tet, the output was raised an appreciable amount, and the note was greatly improved. The suppressor is run at 50 volts positive. In this regard, I wish to remind the reader that if cathode bias is used on a tube like the 802, it is sometimes almost impossible to make the tube deliver any load power even with 50 volts on the suppressor grid. The reason, of course, is that the voltage developed across the bias resistor may be of the order of 60 to 75 volts and with only 50 volts positive on the suppressor grid, it is obvious that the suppressor will actually be 10 to 25 volts negative with respect to the cathode. In order to run the suppressor grid positive with respect to the cathode, it is necessary to have it from 100 to 125

or 135 volts above ground, if cathode bias is used. This is a matter that I have found overlooked in a great many transmitters built around these pentodes. Bear it in mind when applying cathode bias to a pentode tube, when the suppressor is operated positive.

Another thing that is very often overlooked is the voltage on the neutralizing condensers, which causes arcing on closely-spaced condensers. You will notice that I have used parallel feed for my 809, and the neutralizing condenser is connected to the ground side of the blocking condenser, thus avoiding the plate voltage appearing across the neutralizing condenser, or on the tank coil or antenna. This will allow a smaller condenser with closer spacing to be used, and it will avoid arcing even under modulation.

Using a 7-Mc. crystal and doubling to drive the 809 on 14 Mc., the 802 as a Tri-tet does not give power enough to drive the grid of the 809 sufficiently for modulation, and I found it necessary to add an oscillator tube when I tried to modulate the 809. If 'phone operation is required, I would suggest using the 802 as a buffer and exciting it from another tube. This is also better practice, as it isolates the oscillator from the modulated tube. It is an easy change to make, for the crystal tube may be put in the socket used for the cathode coil of the Tri-tet and, by using one of the new crystal sockets that mount above the chassis, the added

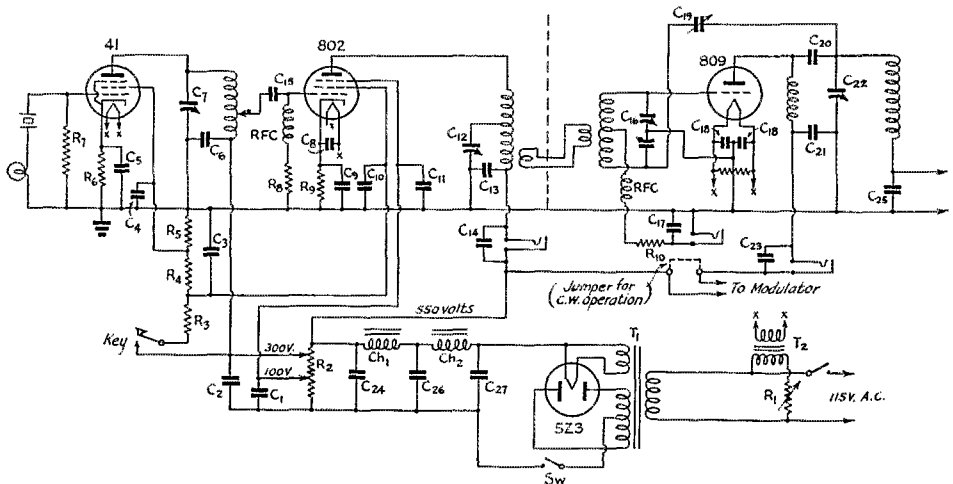

Fig. 2—Wiring of the transmitter when used for 'phone.

- |                                                                |                                                       |                                          |
|----------------------------------------------------------------|-------------------------------------------------------|------------------------------------------|
| $C_1$ —4- $\mu\text{fd.}$ electrolytic.                        | $C_{19}$ —10- $\mu\text{fd.}$ neutralizing con-       | $R_3$ —400-ohm, 2-watt.                  |
| $C_2$ —24- $\mu\text{fd.}$ electrolytic.                       | denser.                                               | $R_4, R_8$ —10,000-ohm, 2-watt.          |
| $C_3$ —2- $\mu\text{fd.}$ paper.                               | $C_{24}, C_{26}$ —4- $\mu\text{fd.}$ , 600-volt elec- | $R_5$ —20,000-ohm, 2-watt.               |
| $C_4, C_{10}, C_{11}, C_{18}$ —0.006- $\mu\text{fd.}$ mica.    | trolytic.                                             | $R_6$ —350-ohm, 1-watt.                  |
| $C_5, C_8, C_9$ —0.01- $\mu\text{fd.}$ paper.                  | $C_{25}$ —Five 0.00015- $\mu\text{fd.}$ mica in       | $R_7$ —20,000-ohm, 1-watt.               |
| $C_6, C_{13}, C_{20}$ —0.001- $\mu\text{fd.}$ mica.            | parallel.                                             | $R_9$ —650-ohm, 10-watt.                 |
| $C_7, C_{12}, C_{22}$ —50- $\mu\text{fd.}$ variable.           | $CH_1$ —20-henry filter choke.                        | $R_{10}$ —1500-ohm, 10-watt.             |
| $C_{14}, C_{15}, C_{17}, C_{21}, C_{23}$ —100- $\mu\text{fd.}$ | $CH_2$ —5-henry filter choke.                         | $R_{11}$ —60-ohm center-tapped, to carry |
| mica.                                                          | $R_1$ —100-ohm primary rheostat.                      | 100 ma.                                  |
| $C_{16}$ —50- $\mu\text{fd.}$ each section split-              | $R_2$ —50,000-ohm, 50-watt voltage                    | $T_1, T_2$ —Same as Fig. 1.              |
| stator.                                                        | divider.                                              |                                          |

tube is an easy thing to achieve. With this tube added, it is easy to get the necessary 32 or 35 mils grid current on the 809.

The modulator used is designed to reduce all frequencies under 200 cycles and above 3000 cycles and, with a pair of 6F6G tubes operating class AB1, gives much more audio power than is necessary to modulate 100 per cent with voice.

### Construction

The power supply and r.f. portion are all on one 10-inch by 17-inch by 3-inch chassis. The power supply is mounted along the back edge of the chassis and the r.f. components on the forward edge, all condensers being mounted under the chassis. This would seem to make for long leads, but the fact is that they are not long but quite direct and short.

The controls are as follows, from left to right: Cathode-tank tuning condenser for the Tri-tet, or crystal-oscillator plate tank when the separate tube for 'phone operation is used; d.c. high-voltage switch, key jack, tuning condenser for the 802 plate circuit, plate-current jack for the 802, grid-current jack for the 809, grid-tank tuning condenser for the 809, plate-current jack for the 809, 110-volt a.c. switch, plate-tank tuning condenser for the 809. Each inductance is mounted directly above its respective condenser.

This transmitter was built up of parts that have been around for years. Anyone building a similar one could save a great deal of space by using the new small oil-filled condensers in the filter. The condensers I used were many years old, and of the old paper overgrown size, as can be seen.

All wiring is conventional. The link between the 802 and the 809 was found to deliver much more power with two spaced wires than with a twisted pair, and it is made of a pair of No. 12 solid wires, spaced  $\frac{1}{8}$  inch.

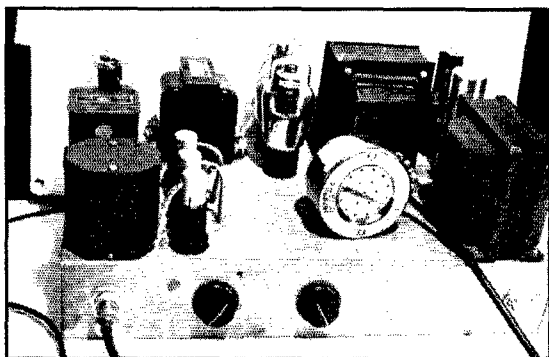

A general view of the speech amplifier, modulator and modulator power supply.

The r.f. choke and blocking condenser for the 809 are mounted directly behind the socket of the 809 plate tank inductance, giving a short, direct lead to the plate cap of the 809 for both d.c. and r.f. All d.c. high-voltage leads were run in shielded wire, to prevent any stray coupling through the supply network. The 809 neutralizes nicely, and has no tendency at all to go off on its own.

For c.w. operation, the 802 Tri-tet is plenty of driver, and the arrangement makes a nice compact two-tube transmitter. For 'phone operation, the addition of the separate driver tube was found necessary. I chose a 41 type tube for crystal oscillator because of its small size and its being a pentode. The plate potential was taken from the tap for the screen grid of the 802 on the bleeder resistor. This gives 300 volts for the plate of the 41, and its screen grid is fed from a divider of 10,000 ohms and 20,000 ohms to ground. It oscillates very nicely and, with a 14- or 7-Mc. crystal, will deliver plenty of power with the drive for the 802 being tapped way down on the plate coil. This allows the oscillator to run lightly loaded and yet drive the 802 to plenty of output.

The number of turns on the tank coils are not given, for the reason that anyone building this transmitter will have to cut and try anyway. Any of the coils given in the *Handbook* will be a good starter. The Decker coils, of course, are pre-wound and will be correct if used.

The grid-tuning condenser for the 809 is the only split-stator one used. All condensers are mounted on the chassis with rotors grounded, with the exception of the neutralizing condenser. Small mica blocking condensers and the series feed tanks are used to accomplish this.

No provision was made to measure the plate current of the 41. The important thing is the r.f. crystal current, and a small pilot lamp is put in series with the crystal to indicate that current. The screen grids of both the 41 and the 802 are keyed. With

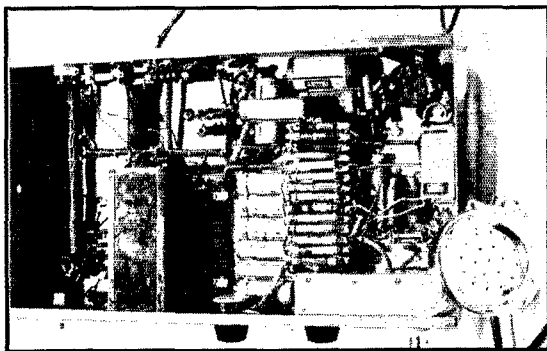

A shot underneath the audio chassis shows the arrangement of the resistors on a single terminal strip and also the shielded-input compartment (upper left-hand corner) for the microphone plug.

this arrangement good keying is obtained, without key clicks.

It might be of interest to mention that I tried a small amount of cathode bias for the 809, but had to remove it because under modulation the increase in plate current raised the bias to such a value that downward modulation resulted. Removal of the cathode bias cleared it up.

### Modulator

The modulator and its power supply are also built up on a 10-inch by 17-inch by 3-inch chassis. About the only thing of special interest in the modulator, which uses conventional AB1 output, is the method of hum and frequency discrimination used.

Since I operate portable most of the time, when often a good ground is almost impossible to obtain, I found that the only microphone I could use with any degree of success was a dynamic one with the low output impedance of 50 ohms. I bought a nationally-known input transformer, which was supposed to have hum-bucking windings and consequently a very low hum output. But the fact was that, regardless of where I mounted that transformer, or in what position, the hum was so bad that it could be heard with ease with a pair of phones across the secondary. I almost gave up trying to use it, and I was going to try using resistance coupling from the microphone to the first grid, but I thought I would play around with inverse feedback and cutting off the low frequency response for the amplifier, to see how far I could go by that method. This was very successful.

It is a practice in ham audio work to use high values of grid resistors, on the order of 500,000 ohms or more. This favors low frequency response. We have to change our habits and go the

other way to get rid of hum. By using 50,000-ohm grid resistors, we can attenuate the low frequency; 100 cycles is cut about 8 db by this low value of resistor. Then, by using 500,000 ohms or more in series with the grid, we can cut the lows some more. By using both, the hum frequency of 120 cycles is almost completely eliminated. Then, too, introducing inverse feedback to the input transformer as shown helped the hum trouble no end. By using coupling condensers of small values between stages, in addition to the above, the problem was solved. It was fun playing with this problem, and anyone interested can spend a pleasant afternoon with a few resistors and condensers.

In the final form, the hum is heard with the volume control full on, but it is not objectionable. With the control operated where it gives plenty of audio to modulate the transmitter, the hum is just visible on the oscilloscope and can be just barely heard.

The circuit is self-explanatory, but it might be a point to mention that I had to use the 200-ohm primary connection on the input transformer for the 50-ohm microphone and thereby was able to ground the center point of the primary and get a balance to ground on that winding. This will also allow the use of a single or double button carbon microphone. Anyone wishing to tackle the hum problem can lick it in this way.

I chose a 6E6 for the driver tube, as it is a low- $\mu$  dual-triode tube and works well enough with transformers designed for 45's. It is not a perfect match but is near enough to work well at voice frequencies. I would rather drive the modulator tubes with a transformer than with a resistance-coupled phase inverter. The 6E6 looked like the answer, since I had the push-pull transformers for 45's. It was. The driver trans-

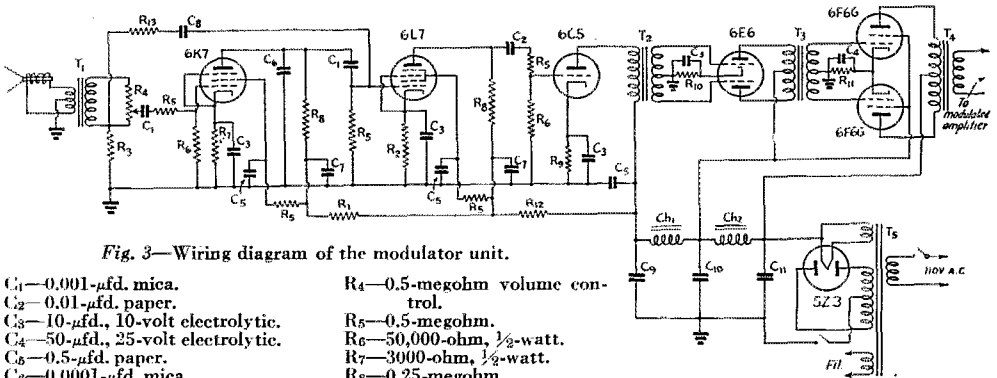

Fig. 3—Wiring diagram of the modulator unit.

- |                                                              |                                                         |
|--------------------------------------------------------------|---------------------------------------------------------|
| C <sub>1</sub> —0.001- $\mu$ fd. mica.                       | R <sub>4</sub> —0.5-megohm volume control.              |
| C <sub>2</sub> —0.01- $\mu$ fd. paper.                       | R <sub>5</sub> —0.5-megohm.                             |
| C <sub>3</sub> —10- $\mu$ fd., 10-volt electrolytic.         | R <sub>6</sub> —50,000-ohm, $\frac{1}{2}$ -watt.        |
| C <sub>4</sub> —50- $\mu$ fd., 25-volt electrolytic.         | R <sub>7</sub> —3000-ohm, $\frac{1}{2}$ -watt.          |
| C <sub>5</sub> —0.5- $\mu$ fd. paper.                        | R <sub>8</sub> —0.25-megohm.                            |
| C <sub>6</sub> —0.0001- $\mu$ fd. mica.                      | R <sub>9</sub> —2000-ohm, $\frac{1}{2}$ -watt.          |
| C <sub>7</sub> , C <sub>11</sub> —8- $\mu$ fd. electrolytic. | R <sub>10</sub> —400-ohm, 2-watt.                       |
| C <sub>8</sub> —0.25- $\mu$ fd. paper.                       | R <sub>11</sub> —200-ohm, 2-watt.                       |
| C <sub>9</sub> —24- $\mu$ fd., 450-volt electrolytic.        | R <sub>12</sub> —50,000-ohm.                            |
| C <sub>10</sub> —16- $\mu$ fd., 450-volt electrolytic.       | R <sub>13</sub> —0.15-megohm, $\frac{1}{2}$ -watt.      |
| Ch <sub>1</sub> , Ch <sub>2</sub> —20-henry filter chokes.   | (Resistors are 1-watt except where otherwise specified) |
| R <sub>1</sub> —50,000-ohm.                                  | T <sub>1</sub> —Microphone input transformer.           |
| R <sub>2</sub> —500-ohm, $\frac{1}{2}$ -watt.                |                                                         |
| R <sub>3</sub> —11,000-ohm.                                  |                                                         |

- T<sub>2</sub>—Push-pull input interstage transformer.  
T<sub>3</sub>—Driver transformer (45's to Class-B 10's).  
T<sub>4</sub>—Modulator output transformer.  
T<sub>5</sub>—Plate supply transformer 350-0-350 volts at 150 ma.

former used was for 45's to class B 10's. Using it for the 6F6G's in class AB1 works nicely, and this saved the cost of a new driver transformer.

By "trying," one finds that the equipment around the shack will sometimes work, but not always. By this time the reader has seen that the transmitter and modulator are in reality junk-box creations in great part. They do the work, however, and for my use this is the best answer to the question of what is the best portable transmitter. As do all hams, I realize that the answer will change as time comes and goes; but for now, at any rate, it is the answer, and I hope it will be for some time to come.

Credit should be given to Les Grube, W9LEX of Saint Paul, Minnesota, for the mechanical work and mounting of equipment in the transmitter and modulator, as well as a good part of the wiring of the modulator. This equipment is the joint brain-child of W9LEX and W7AW.

## Model Three-Element Beam Demonstrated at Pacific-Southwestern Division Convention

ONE of the most interesting talks at the Pacific-Southwestern Divisions A.R.R.L. Convention held at San Francisco was the practical demonstration of a model 3-element rotatable antenna by Clayton Bane, W6WB. The 100-Mc. 3-element beam was supported on the top of a 64½-foot tower and could be rotated in the hori-

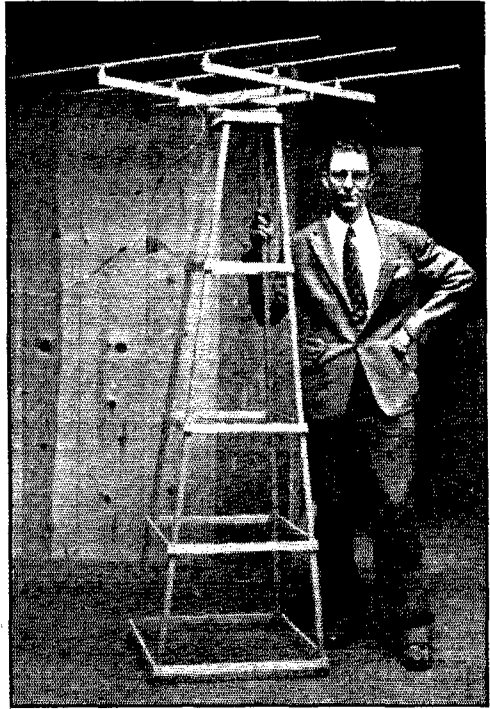

W6WB and the model 3-element beam he demonstrated at the recent Pacific-Southwestern Divisions Convention.

zontal plane and tilted slightly in the vertical plane. The antenna element was fed by a twisted pair, delta-matched at the antenna.

A field-strength meter, designed by Francis Wells, W6QUC, and consisting of a half-wave antenna for pickup and a 30 tube working as a diode rectifier, was used to indicate the signal intensity. It was placed several wavelengths from the transmitting antenna, and a large meter was used so that the audience could easily see the effects of changes in the transmitting antenna.

The power from the transmitter was adjusted so that, with the beam pointed at the field-strength meter, nearly full-scale deflection was obtained on the 0-1 ma. meter used. Rotating the antenna about 30° dropped the meter indication to 0.5 ma., and at 45° rotation the needle was practically at zero. As the antenna was rotated, the needle remained practically at zero until at the back a little radiation showed up, just enough to be readable on the meter. With the beam pointed at the pick-up antenna, a tilt of 20° showed a marked reduction in signal, indicating the sharp vertical pattern of the antenna. Mr. Bane demonstrated the effect of near-by objects by placing his hand near the field of the antenna. The reduction in signal strength showed the im-

(Continued on page 120)

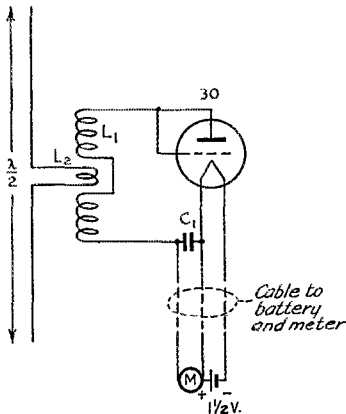

Fig. 1 — Wiring diagram of the simple field-strength indicator.

- C<sub>1</sub> — 0.00025-μfd. midget mica.
- L<sub>1</sub> — 8 turns No. 14 tinned copper, wound self-supporting with diameter of ½ inch and spaced the diameter of the wire. Opened at center to take I<sub>a</sub>.
- L<sub>2</sub> — 1 turn No. 14, ½ inch diameter.
- M — 0-1 ma.

---

# ★ I. A. R. U. NEWS ★

---

Devoted to the interests and activities of the

## INTERNATIONAL AMATEUR RADIO UNION

Headquarters Society: THE AMERICAN RADIO RELAY LEAGUE, West Hartford, Conn.

### MEMBER SOCIETIES

American Radio Relay League  
Asociatia Amatorilor Romani de Unde  
Scurte  
Associazione Radiotecnica Italiana  
Canadian Section A.R.R.L.  
Československí Amatéri Vysílací  
Deutscher Amateur Sende-und-Empfangs  
Dienst  
Estli Raadio Amatooride Uhing  
Experimental Radio Society of Egypt  
Experimenterende Danske Radioamatører  
Federation des Emetteurs Belges  
Irish Radio Transmitters Society

日本アマチュア無線連盟 Japan  
Liga Colombiana de Radio Aficionados  
Liga Mexicana de Radio Experimentadores  
Magyar Rövidhullámú Amatőrök Országos  
Egyesülete  
Nederlandsche Vereeniging voor Internationaal Radioamateurisme  
Nederlandsch-Indische Vereeniging Voor  
Internationaal Radioamateurisme  
Newfoundland Amateur Radio Association  
New Zealand Association of Radio Transmitters  
Norsk Radio Relæ Liga

Polski Związek Krotkofalowców  
Radio Club de Cuba  
Radio Club Venezolano  
Radio Society of Great Britain  
Rede dos Emissores Portugueses  
Reseau des Emetteurs Français  
Reseau Luxembourgais des Amateurs d'Ondes Courtes  
South African Radio Relay League  
Suomen Radioamatöörlitto r.y.  
Sveriges Sändareamatörer  
Unión de Radioemisoras Españolas  
Union Schwela Kurzwellen Amateur  
Wireless Institute of Australia

### WAR

IT WILL be the duty of this department during such period as there exists a state of war in Europe, while remaining completely neutral in all respects, to be as complete and accurate as possible a reporter of international events affecting amateur radio.

In these troubled times, when rumors fly fast and even facts change from day to day, it is not feasible to label any international data as correct or complete. However, we have compiled from a myriad of various sources the information appearing below. We emphasize that these may not be facts, but are merely abstracts of current available data at the time of publication.

The following countries are off the air as belligerents: G, GI, GM, GW, F, SP, VE, VK, YM and ZL. All the innumerable colonial possessions of the British and French empires are also off. Apparently purely as a precautionary measure, ON and PA hams have been closed down; in fact, the Belgians seem to have been the first amateurs to be put off. Portuguese amateurs received orders to close down September 12th, except that the society is authorized to continue radiotelephone operation with the U.S.A. and South America only, which authorization may extend to some of their member-stations. Switzerland and Ireland are off the air. At this writing, it is rumored that OZ was closed October 1st.

The Cuban close-down on September 9th was a permanent one for experimental stations, but was for one month in the case of amateurs, with the possibility of extension another month, while new regulations are being prepared and new licenses issued. The order itself is said to have been a result of the misinterpretation of a humorous remark in a local magazine about spies; according to the order, the shutdown was because amateurs

were generally interfering with broadcast stations and using excessive power, and was represented as not related to the war situation. Haitian amateurs were closed September 13th, "to prevent any possible violation of neutrality." Advices are that the closing is temporary, to provide time to look the licensees over; most of them are expected to reopen soon "under certain restrictions."

South African amateurs remain on the air in full force. They tell us their government has simply taken no action towards them and that they hope and expect to continue in the normal way. With the exception of Cuba and Haiti and possibly colonial possessions of belligerents, all of South and Central America are unaffected. In Canada, amateurs are coöperating with their government in monitoring activities — not the amateur bands alone, but an extensive portion of the spectrum. They are also assisting in the construction and operation of radio stations. Word comes that the Swiss amateurs have been completely mobilized. We assume that amateurs in all belligerent nations are in some manner serving their countries.

We are mildly surprised at the scarcity of news from our members. We had expected some delay in the handling of international mail, but not the complete lack of it. Outside of the item next below, we are appallingly devoid of news on the activities of our European member-societies since the first of September.

### R.S.G.B.

WE WELCOME the news that the Council of the *Radio Society of Great Britain* unanimously voted for continuance of the organization even in the face of present disrupted conditions. It is planned to continue monthly publication of the society's journal on a small scale. The QSL

Bureau will now be handled by Arthur O. Milne, 29 Kechill Gardens, Hayes, Bromley, Kent, to whom all cards confirming past contacts with English amateur stations should be sent. The registered address of the society will continue to be 53 Victoria St., London, S. W. 1, to which address all correspondence should be sent, but actual headquarters operations will be carried on from the private home of the secretary-editor. It is unfortunate that the extended plans for the 1939 convention had to be cancelled.

#### KIEL CONVENTION

THE D.A.S.D. were more fortunate than the British society in that their convention was scheduled in May of this year. The primary purpose was to provide those interested in amateur radio, especially the officers of the various local clubs, with an opportunity to become familiar with recent technical developments and to familiarize anyone who might be interested with the details of naval and marine transmissions. Organizational details, it was pointed out by the president, which had required so much time in the past year, were now completed and members could in the future again devote their time to the technical aspects of short-wave communication — the primary purpose of the society. Encouragement was given to all those interested in ultra-short-wave transmission to carry on experimental work. A committee was organized to aid all amateurs interested in television.

#### NEW GUINEA

IN THIS "world's largest island" is a little group of amateurs who formed the *New Guinea Amateur Radio League* as an affiliate of the W.I.A. From an interesting letter, we learn that the country is very volcanic and mountainous; rainfall is quite heavy and in some districts reaches as high as 200 inches annually. This makes road construction difficult and landslides make it expensive, so that most of the transport about the interior is by air. The fact that the amateurs are so scattered and that normal communications services between districts are scarce — no roads, telephones or telegraph — makes amateur radio extremely valuable. The 40-meter band is the only one useful to them for local work, as 20 is out on account of skip usually and 80 and 160 mostly unworkable on their low power owing to QRN. Says President Williams, "There are only a few of us, we are widely scattered about the countryside, and when the 'wind' is with us we go over your way. In addition, we QSL 100%." Too bad that all this now has to be written in the past tense.

#### W.A.S.

THE W.A.S. award is no easy accomplishment for American amateurs, and it becomes a mark of special distinction when a foreign station



VK9WL, Salamanau, New Guinea. Owner L. I. Williams is president-secretary of the New Guinea Amateur Radio League.

achieves it. We publish below a list of stations, excluding those on the North American continent, who have received the award. Italics indicate all contacts made by radiotelephone:

OA4J, K6CGK, *K6MVV*, VK6SA, K6JPD, OE3AH, ZL1GX, VK5KO, LU7AZ, J5CC, ZL4AC, VK2DG, VK2HP, G5BJ, VK4CG, G6QS, VK3CX, ZL2QM, K6HZI, G6NF, G6WY, VK2ADE, VK2RA, ZS6DW, *GM6RG*, *G6BW*, OZ4H, K6OQV, J2JJ, VK5FM, ZS6DY, K6OQM, *G6WT*, ZS6CZ, PY2AC, ZL1HY, ES5C, GI6TK, G2ZQ, G6CL, K6LKN, G2MI, ZL2MM, K6PGQ, VK2QL.

#### SWL BUREAU

THE territory announced in our last issue as being covered by Mr. Mayes is now being handled by Edwin Goodbout, 503 N. Genessee St., Waukegan, Illinois.

### Wide-Range Tank Circuit

(Continued from page 39)

nism, the latter also should be located near the low-potential end of the coil.

This general type of inductance-and-capacitance variable tank may be used for crystal oscillator plate circuits, grid and plate tuning of the r.f. amplifiers and frequency multipliers, and for some types of antenna tuning as well. It need not be limited to the three bands mentioned above, but no doubt could be adapted to any three consecutive bands except possibly in the u.h.f. range.

### Strays

Grooved forms for space-wound high-frequency chokes can be easily made by running a half-inch die or threader over half-inch hard-rubber tubing.

— WSPUY



# HINTS AND KINKS FOR THE EXPERIMENTER



## DIRECTION FINDING WITH B.C. PORTABLES

HERE is an idea that I think might be of interest to those amateurs who also enjoy boating.

The recent trend toward the carry-about radio has produced a receiver having characteristics desirable for a direction finder on board small water craft. Any of the several makes of these self-contained receivers may be used to take bearings on broadcast stations to determine position while at sea. To do the job, the receiver is mounted on a rotatable platform up above any surrounding metal objects. On top of the receiver is mounted a good compass the case of which is fastened so as to rotate with the receiver. Watch out for the speaker field.

To calibrate first the apparatus it will be necessary to determine accurately the directions from your port to two or three local broadcast station antennas. After doing this, tune in one of those stations and rotate the receiver until the signal is absolutely the weakest and set the compass case to read in the same direction as the known direction. Check two or more stations in other directions and make corrections if necessary.

These receivers are bi-directional and sometimes will not work the same off both sides so always remember to use the same side of the receiver when taking bearings as used when calibrating the compass. Don't try to navigate by dx stations because their signal paths often are not in the true direction of the antenna. With accurate bearings it is possible to determine your position within 1/4 mile from signals 70 to 100 miles away.

— Francis L. Sherwood, W8NCM

## ROTATABLE ANTENNA SUPPORT FROM AUTOMOBILE PARTS

IN MARCH QST, W5EOW described a bamboo fishpole rotating antenna for 20 and 10 meters. One was constructed and found to perform admirably as far as contacts were concerned, but it did not stand up in heavy northern weather as well as it might have. After considerable experimental changing, a welded steel channel support was developed to hold the bamboo poles instead of the original wooden platform; also a short center pole was added. Both of these changes effectively increased the rigidity and strength of the unit without exceeding by more than \$5.00 the original cost or impairing the performance in any way.

A Model-A Ford front wheel brake drum (welded steel, not cast-iron type) with associate roller bearings, races and spindle was selected for the foundation. Thus, with one trip to the junk yard, half the work in the antenna is completed and you have no worries about this strong, easily rotated assembly when the winds blow. All that remains are the four bamboo poles (18-ft. poles are used instead of the 22-ft. length), a bamboo pole 9 ft. in length for the center support, four steel channels 1 1/2" by 1 1/2" by 1/8", each 2 ft. long; about 6 feet of 1/8" by 1" steel band for braces; two pieces of wood 1" by 2" 4 ft. long for the center pole, miscellaneous bolts and nuts, rope, antenna wire and insulators. The channel size is correct for bamboo poles up to 1 1/2" diameter. The poles are lashed with wire to the channels in two places. Strap bolts can be used but are not necessary. When purchasing the brake drum and spindle, be sure to include the spindle nut and the dust cover for the drum housing.

The big job and the heart of the antenna is the brake drum. The sketches of Fig. 1, A and B show how the channels and associated parts are orien-

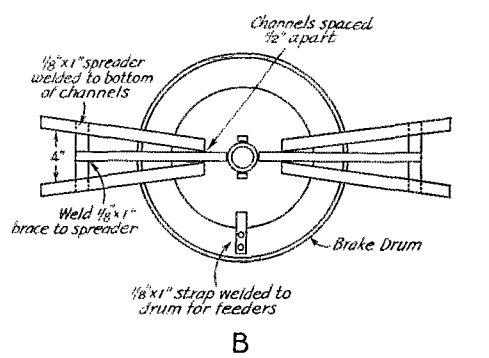
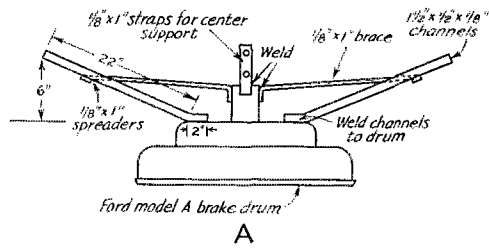

Fig. 1 — Top and side elevations of rotating head.



tated, braced and welded. Cut the channels to a length of 2 ft., weld the 4" separators, then weld to the brake drum. After welding, bend the channel about 3 inches away from the drum with an acetylene torch. Raise the channel to the proper angle by holding a wood block 6 inches long under the ends of the channel and at the same height as the top of the drum. This method enables you to gauge the bend of the channel while heating, and is simpler than bending all four channels before welding to the drum. The rise of the channels given is the best for holding the bamboo poles in position and should not be raised or lowered without changing the height of the center pole. Measure, cut and weld the long  $\frac{1}{8}$ " by 1" steel braces after the channels are bent into position. Electric weld all parts to the hub if possible, otherwise use an acetylene torch. The channels are bent with the acetylene torch. While at the welders, have the lugs burned off the spindle. This sounds like a lot, but your bill should not run over \$3.00 for welding. Also include the two 6" pieces that hold the center pole. Drill the holes before welding. A third piece, same size, is welded to the drum. The piece is used to hold a short length of 1" by 2" that keeps the feeders away from the drum. If you prefer, slip rings could be mounted under the protection of the drum, but since this antenna is bi-directional, the feeders will swing 180 degrees if you allow a loop near the antenna and use several extra spreaders to keep the feed line from crossing at the maximum positions.

After the lugs have been burned off the spindle, let this part cool slowly. Do not cool in water or oil as this will make the spindle brittle. With lugs removed, the spindle can be bolted to a tower or pole with bolts or lag screws through the four holes in the bottom plate.

The center pole is made with the two 1" by 2" pieces cut 4 ft. long. The tops are bolted together and the bottoms spread and bolted to the brackets welded on the hub of the drum. It is a good idea to use a dirt cover (hub cap) over the spindle. The cover keeps out rain and snow. Pack with grease and trouble-free rotation is insured for 10,000 miles. Two angle brackets are fastened to the tops of the 1" by 2" pieces and to them is lashed the 9-ft. bamboo center support. Most rug dealers will give you a 9-ft. pole if you haven't one handy.

The wire length and spacing is conventional. Assemble the center pole and support first. Attach all insulators and wire, cut to length before fastening the bamboo poles in place. An insulator with antenna wire attached is wire lashed to the end of each bamboo pole. Then the bamboo poles are raised and laid in the channels. They can be moved up or down the channels or rotated to get all uniform and can then be lashed securely to the channel with wire.

The antenna can be rotated by means of a turn

of rope around the drum or by two ropes attached to the ends of the channels. The choice depends on the location and to what extent you wish to go with the controlling mechanism. Only 180-degree rotation is required.

Two coats of paint are recommended for the steel drum and other parts. The bamboo poles should last several years if kept varnished each year, or you won't have to worry about them if you don't care about a 25-cent replacement once in a while. All changes can be made at the center of the antenna so if your mast is sturdy enough to climb, a new bamboo section can be wired in place in a few minutes.

— Edward E. Schultz, Jr., W9UHA

### MEASURING RADIO-FREQUENCY POWER OUTPUT

OF THE several available methods for measuring power output from a radio transmitter, only one has received any considerable attention in the literature of amateur radio. Most "hams" are familiar with the use of incandescent light bulbs, in conjunction with a calibrated photometer or a visual estimation of "normal brilliance," for the approximate determination of power output. Our experience with the difficulty of getting an impedance match between the output of the transmitter and the lamp bank load, with the inaccuracy of visual estimation of brilliance, and with the expense of photometric indicators, led us to try an alternative method for measuring the power output from our transmitter.

The theory of the method is based on the fact that there are quantitative relations (1) between the power output of the transmitter and the rate at which it produces heat in a resistive load, and (2) between the rate of heat production in the load and the rate of temperature rise of the load. The first of these relations is expressed by the formula,  $W = 4.18 C_s$ , where  $W$  is the power output in watts, and  $C_s$  is the rate of heat production in calories per second. The second relation is expressed by the formula,  $C_s = \frac{M_s T_c}{60}$ , where  $C_s$

is as above,  $M_s$  is the equivalent mass of the heat absorbing system in grams, and  $T_c$  is the rate of temperature rise in degrees centigrade per minute. The equivalent mass of the heat absorbing system is found by multiplying the mass of each component of the system which absorbs heat by its specific heat, and adding the separate products. The two formulas may be combined into the

following,  $W = \frac{4.18 M_s T_c}{60}$ . The application of

this formula will become clearer when we trace its use in a specific problem.

The apparatus used for making the power measurements is shown in the photograph. The calorimeter cell on the left is a pint fruit jar. It is

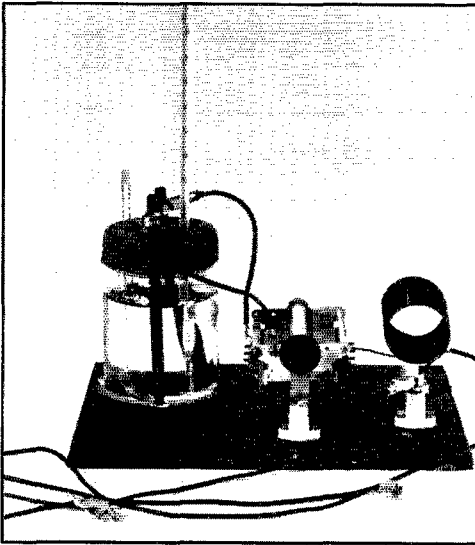

The set-up used in making r.f. power output measurements.

covered with a rubber cap, which is sold in dime stores for opening fruit jars. Holes drilled through the cap fit snugly about the thermometer and electrodes, holding them in position. The stirrer, of course, moves freely. A dime store Fahrenheit thermometer may be used, provided that the temperature changes indicated on it are multiplied by  $\frac{5}{9}$  to convert them to centigrade changes. Arc carbon electrodes are preferable to metallic electrodes because of their freedom from electrolytic attack. A second rubber cap, cut in quarters, tacked to the baseboard, and bound at the circumference with friction tape, forms the support of the jar.

The fluid in the jar is water. Its impedance is varied to match the loading of the antenna by varying the amount of dissolved salt or mineral matter it contains. Our first thought was to match the impedance by raising or lowering the electrodes, but we found that the variation obtainable by that method was very slight. Since our transmitter works into a voltage-fed antenna, the impedance of the cell had to be kept rather high. For measurements on 20 meters, we found that city water, plus a little salt, would do the job nicely. On 40 meters it was necessary to add some distilled water to the tap water, and on 80 meters, almost pure distilled water was necessary.

The cell as constructed has a capacity of about 50  $\mu\text{mfd}$ . In order to make it present a purely resistive load to the transmitter it was necessary to connect a parallel resonant circuit across it. The circuit is adjusted by tuning the condenser for minimum plate current. If you have a suitable condenser in the junk box, the entire apparatus can be constructed for less than one dollar.

In order to understand the use of this apparatus let us follow through an actual case of power measurement on 20 meters. The grocer's scale tells us that the jar, stirrer and electrodes weigh about 12.8 ounces. (We let the exposed portions of the stirrer and electrodes make up for the immersed part of the thermometer, in figuring the weight of the heat absorbing materials.) Since one ounce equals about 28.3 grams, we figure the weight of the jar and accessories to be 362 grams. Taking 0.16 for the specific heat of the jar and accessories, we get approximately 58 grams ( $362 \times 0.16$ ) for the equivalent weight of the jar, stirrer and electrodes.

A convenient volume of water to use in a pint fruit jar is 12 ounces. (The XYL's kitchen equipment comes in handy for measuring this.) One ounce of water weighs about 29.6 grams. This gives us 355 grams for the weight of the water. Since the specific heat of water is 1, its equivalent weight remains 355 grams. Adding this to the 58 grams previously obtained, we have 413 grams for the equivalent mass ( $M_e$ ) of the heat absorbing system.

When this value is substituted in the formula

$$W = \frac{4.18 M_e T_e}{60}$$

and the expression simplified,

we get  $W = 28.8 T_e$ . This formula can now be used for each measurement made, without repeating the preceding calculations.

We are now ready to make the actual measurements. By adding salt to the tap water, the resistance of the cell is adjusted so that the plate current in the final with the watt meter connected is the same as when the antenna is connected. The cell is then cooled in running water or in the refrigerator until it is five or ten degrees cooler than room temperature. By continuing the measurement until the temperature in the cell is five or ten degrees warmer than room temperature, we balance out the effect of loss or gain of heat from the surrounding air.

With the cooled cell back in place, the transmitter is turned on and the initial readings of time, temperature and plate current are taken. When the temperature has risen to about five degrees above room temperature, we take the final reading of temperature, time and plate current. Here are the results:

	<i>Initial</i>	<i>Final</i>
Time . . . . .	8:47	8:52
Temperature . . . . .	19.0	31.7
Plate Current . . . . .	147	155

Since the temperature changed 12.7 degrees in five minutes,  $T_e$  equals 2.54. Placing this in the formula  $W = 28.8 T_e$  we obtain 73.2 watts for the apparent power output. One correction needs to be applied to this value to get the true power output. Not all of the power output has gone into

(Continued on page 108)



# CORRESPONDENCE FROM MEMBERS

The Publishers of *QST* assume no responsibility for statements made herein by correspondents

## IT REALLY WORKS:

Editor, *QST*:

Ruthilda, Sask.

It may interest you to know that, through extensive experiments carried on in our laboratory, we have finally developed an entirely new system of radio transmission, one that is notable because of its simplicity and economy.

Briefly, the system requires but a few parts to put into operation, as follows: (A) one tomat, (B) one neon bulb, (C) a system of exciting tomat. Procedure is as follows: Stroke tomat at a steady rate of fifteen strokes per minute, and apply neon light to tomat's nose. Considerable r.f. will be obtained. Connect resonant antenna to cat's tail, with key in series. If cat is properly excited resulting note will be quite similar to some heard on the amateur bands. Two tomat's in pushpull would be more desirable, but perfect match must be had. Power output goes up as speed of stroking increases, but excitation must be controlled.

Room lighting effects may also be obtained through this same system of applied neon light. A very peaceable cat must be obtained, however, otherwise results may be varied.

— H. A. Walker, VE4BN, and W. N. Veale, VE4OQ

## CUT-THROAT COMPETITION

920 Eighth Ave., Brooklyn, N. Y.

Editor, *QST*:

During recent years which have brought great developments and technical advances in radio, and at the same time the most severe depression in American history, I have regretfully watched the art being exploited by a few to the detriment of all. Cut-throat competition is the most common way of referring to the practices I mean, though I feel that the expression does not begin to paint a full picture of such practices, or their far-reaching consequences.

One manufacturer will bring out a piece of equipment, a receiver, for example, which will do something that no other receiver has ever done; it has wider frequency response, it tunes with a single control, it receives short waves, or perhaps it is merely so conservatively built that it will stand up indefinitely. Mr. Fly-by-Night Manufacturer will promptly go to work and turn out a Chinese copy of the instrument, which little theft isn't so bad in itself. But instead of making some little improvement in his instrument, or least trying to equal the quality of the original, he will cut every available corner, using lower voltage condensers, lower wattage resistors, a tin speaker, and a veneer cabinet, in order to be able to sell the receiver for 40 per cent of the price a quality receiver in the same class should cost. But Mr. Fly-by-Night Manufacturer doesn't get rich because there is always some other manufacturer who pops up and gets just a little bit cheaper.

This sort of thing happens in all but a lucky few industries as well as in practically every branch of the radio industry, so little wonder that it is an old story to all of us.

Looking back through these past few years, it might look as if the radio world could have escaped the effects of massacring quality for the sake of price-cutting, since those who did the real development work are those with high standards who would be the last to sacrifice quality or workmanship. But apparently, as in most other fields, things have got out of control, and the evil can only be fought at the consumer end.

The consumer end, generally speaking, is a poor place to combat junk manufacturing because it is usually difficult to convince a consumer that he should spend more money.

Fortunately, in radio it is a minority which willingly and foolishly resorts to poor workmanship and low price to sell its product or service. Of course, even among the larger companies those who have never sacrificed quality for price can be counted upon the fingers of one hand, but

no reputable manufacturer or service organization does an inferior job willingly; when forced to put out a competitive line he does not discontinue his quality line in which he takes pride and hopes he can sell.

We amateurs, sprinkled throughout the country, are in a position to know good and bad apparatus in the radio line, and we are also in a position to see and feel the effect upon the art in general, of the latter. . . .

We amateurs can exert influence against cheap, inferior equipment and we should do so whenever we get the chance.

Sometimes it is difficult to resist a bargain, but almost every amateur who has been in the game for a few years has learned from unhappy experience that it pays to buy good merchandise from a reputable manufacturer. In the amateur world it only remains for us to convince newcomers of this great truth before they have contributed too much to the upkeep of the down-with-quality, down-with-price, manufacturer or dealer. In the lay world we are often consulted by our friends as being, comparatively speaking, radio experts. In recommending a radio receiver or other apparatus to friends, remember that chickens come home to roost. A single purchase of junky merchandise lowers the standards of an entire industry by a small amount. This is felt by all of us; doubly, if, in addition to being amateurs, we work in the industry.

— Robert A. Kirkman, W2DSY

## WHO HAS THE DOPE?

Editor, *QST*:

Bruni, Texas

How many of us have at one time or another thumbed through our lengthy files of *QST* in search of a remedy for either transmitter or receiver trouble? I should judge a great many more than there are members of the League.

I am eighteen miles from any commercially-available a.c. My power supply consists of a 5-kw. single-cylinder engine coupled to a 3-kw. a.c. generator with several V8 fan belts. The voltage stays on the mark, and an electric clock keeps time.

But someday my 110-volt a.c. will fail. Someday I'm going to need help when the exciter or the generator "goes soft." No doubt I will again resort to my old thumb-worn copies of *QST* for a cure.

Surely some ham knows how to re-wind generators, or what to do when brushes start cutting the collector rings. Or has found that taking the end play out of the shaft will cure QRN.

And you fellows in the A.R.R.L. Emergency Corps — if the armature gets soaked, just how long will you have to bake it, and how hot do you dare get it? Let's not keep such an art a secret. If the solutions to my problems can't be found in *QST*, I'm sunk. I can't run and ask Charlie; I've had only one personal QSO with a ham in five years, and he didn't understand generators.

Let's have some dope.

— D. A. Nightingale, W5EGV — ex-W6ETH

## PRIDE

Bethany, W. Va.

Editor, *QST*:

Enclosed find check for membership in A.R.R.L. I am a new ham and hope that I may uphold the traditions and practices of the League. I happen to be a college professor and mayor of the city, but I am more proud of my ham ticket than any honor I have ever received. Guess I appreciate it because it really took hard work to get it. (Teaching college biology does not help one much with code and radio theory.) Well, I now have the old ticket and hope that I can take my place among the fine bunch of fellows on the air.

— W. J. Sumpstine, W8TID



# OPERATING NEWS



**Current Activities.** Operating features arranged by A.R.R.L. are open to every licensed amateur. The opportunity offered in the 2ND U.H.F. CONTEST, November 4th and 5th, is given full announcement elsewhere in this issue. S.C.M.'s are taking steps to have u.h.f. stations on the air these dates in every part of the country . . . a chance for everybody to make new contacts, which in turn gives everybody a score. THE 10TH A.R.R.L. SWEEPSTAKES (November 11th-12th and 18th-19th) also announced in this issue, needs no introduction! Long a major activity, the all-Section opportunities create unparalleled W.A.S. opportunity. Many who find the DX bands less intriguing, with amateurs of so many countries off the air due to the war, will find a new high in operating success and fraternalism through the "SS."

THE NAVY DAY RECEIVING COMPETITION will be well worth the attention of every real amateur, too. Announcement was on page 20 of last QST. Be at your receiver on the early evening of October 27th. We'll look for your reports on all the above.

**Neutrality Responsibilities of Radio Amateurs.** The subject that transcends all others to us amateurs in importance is that of our special responsibilities not alone in keeping neutrality in operating, but also in conducting our radio operating so it is constantly above suspicion, requires no investigating of visitor-talk or other activity, and is completely in accord with F.C.C. regs. The President has proclaimed a limited national emergency with life-and-death powers (almost) over many things that are important to the whole country, and this power, if necessary, may touch us. The President said to Congress, however, that there was no need for further executive action at this time. Only if and when conditions justify and force such government steps, we are told, will the government feel obliged to adopt special restrictions on communications. The League must warn amateurs, however, that the full continuance of our amateur radio depends on our perfection in adhering to our regulations, at the same time we are watchful of the neutrality content of our communications.

**F.C.C. Warning.** The Federal Communications Commission has announced the suspension of two amateur operator licenses (Bruce A. Koppenhaver, W3FSU, Pottstown, Pa., and Albert E. Chatel, W1DIF, Wales, Mass.) and with these suspensions for COMMUNICATING WITH AN UNLICENSED STATION in one case, and for PERMITTING UNLICENSED OPERATORS to use equipment in another, the F.C.C. issued a

warning to this effect: *That any further unauthorized activities by amateur stations during the period of the European war may tend to bring about the curtailment of amateur operation generally, that the Commission now regards it doubly necessary that United States amateurs observe their regulations closely, and the Commission urged all amateurs to take steps at once to prevent any new deviations from regulations.* We might add that the F.C.C. imposed heavier than usual penalties in these cases.

The continuance of amateur radio in the United States apparently depends on perfect observance of all F.C.C. regulations and strict observance of neutrality. Our A.R.R.L.-amateur neutrality code has been published. All amateurs must make it their personal business to notify and warn any operator mentioning matters related to war, or engaging in any improper or irresponsible radio work or action. A neutrality code is not alone enough assurance that restrictions will not be invited by amateur stations. There must be perfect compliance with every F.C.C. regulation. Each licensee must show himself truly a highly responsible operator and citizen. The F.C.C. stated that in one case of suspension the licensee "willingly and knowingly allowed an unlicensed operator the use of his station." In the other case the amateur "communicated with an unlicensed station" (not permitted under Sec. 152. 14, F.C.C. regulations). Why are these examples emphasized by the F.C.C.'s warning? What practices might be especially dangerous while we maintain our war neutrality?

As we see it, our government knows that we have passed tests of citizenship and technical qualifications. But if, contrary to our regulations, we work "uncertified" people who may not be citizens or persons whose responsibility has been certified by a government, the responsible agencies may feel obliged to check into what is going on. Radio communication, remember, jumps over county, state, national, and continental boundaries. It is *international* in its potential effects.

**There is surveillance.** Every communication we make, every station we contact, is subject to surveillance by designated agencies. At all times when operating we should bear this in mind. Common sense requires that no amateur shall allow anybody without proper license to use his set. No sensible amateur wants to personally receive heavy penalties, or be responsible for a government order that injures all of amateur radio.

*It is recommended that two-way work with European, and especially belligerent nations' amateurs (in any continent) be avoided.* We urge that amateurs not quibble over technicalities to

justify border line work. We should avoid provocation of suspicion by refraining from even harmless work with unauthorized or un-neutral stations. It is best *not* to work any D's, F's etc. heard intermittently on the air. We recommend that you do not. The steps to adopt a neutrality code have already paid dividends in "safety" and it seems to me that as the situation worsens in continued months of war increasing the strains on neutrality, we must sensibly follow additional reasonable precautions as above recommended.

The international situation changes rapidly from day to day. Sinkings, propaganda scares, military reports follow one another. Reports will yet concern illicit radio activity, and we amateurs do not wish to be even remotely mixed up with such. We have had our warning. Let us remember there is surveillance, be watchful, and be completely law abiding amateurs.

It is also especially important to limit anything unlicensed persons may say over one's mike! Keeping strictest neutrality is of vital importance to our country and our own future. These are in reality war times. If any actions of any amateur are of a type indicating *potential* danger to our security as a people, or positive un-neutrality, the government may be expected to live up to its advance warning, to prevent repetition of such incidents. See that your contacts are *not* with questionable stations, or provocative of suspicion or investigations, but that in every operating word and act, your hamming does comply to the letter with regulations, and will bear closest scrutiny or surveillance.

The other day an S.C.M. wrote us that an amateur in his jurisdiction allowed a stranger with a foreign tongue, which he admitted he could not understand, to work direct by voice with a foreign country (South America) for some time. This fellow sincerely regretted his action, when the possible criticism of his individual operator's judgment was pointed out to him, and he of course promised full cooperation with the S.C.M. (W2GVZ). There is a job to be done in properly advising *every* operator who has not yet got the entire concept of his responsibilities in these times.

— F. E. H.

— . . . —  
**BRIEF**

One F-station heard in the amateur band was reported as a propaganda-giving station. Just as we go to press it becomes apparent that two legitimate-sounding D-stations that have been working two-way with U.S.A. in our band are apparently stations of government agencies. They ask those they work about the war, pump for information on public reactions, feelings, etc. In other words they are *asking us to violate our neutrality code*. We must watch and have *nil* to do with any such. We must not give information to a belligerent, directly or otherwise, and had best keep entirely clear of 'em!

**PRIZES FOR BEST ARTICLE**

The article by Mr. Carl C. Drumeller, W9EHC \* wins the C.D. article contest prize this month.

Each month we print the most interesting and valuable article received marked "for the C.D. contest." Contributions may be on any phase of amateur operating or communication activity (DX, 'phone, traffic, rag-chewing, clubs, fraternalism, etc.) which adds constructively to amateur organization work. Prize winners may select a 1939 bound *Handbook, QST*, Binder and League Emblem, six logs, eight pads radiogram blanks, DX Map and three pads or any other combination of A.R.R.L. supplies of equivalent value. Try your luck. Send your contribution to-day.

**How to Operate Well**

**BY CARL C. DRUMELLER,  
W9EHC \***

1. Before the call:
  - Listen over the band, especially in the half (low-frequency or high-frequency) of the band in which your transmitter is located. Your chances of making a contact are better if you answer someone's CQ than if you send out a CQ yourself. If you have a low-powered transmitter and a good receiver, do not waste your time and cause interference by calling weak stations. Make sure that you will not interfere with any local station that is already operating; be courteous.
2. The call:
  - A. In answering a CQ, time the length of your call by these factors:
    - a. The number of stations that can be heard in your end of the band; the more stations, the longer your call should be so that the station will have time to tune you in.
    - b. The nearness of your frequency to the edge of the band. The other operator will start tuning from the edge of the band nearest his frequency; therefore if his frequency is near the high-frequency edge of the band and yours is very near the high-frequency edge, a very short call should be all that is necessary. If the station does not reply to you or *any one else* immediately, call again with a short call. Remember that farther your frequency is from an edge of the band, the longer a call you have to make. Do not make your calls too long, for the other operator will get disgusted and tune away.
  - B. In making a CQ, I recommend a form rather than haphazard calling; it is this:

CQ CQ CQ CQ CQ DE W9EHC  
CQ CQ CQ CQ CQ DE W9EHC W9EHC  
CQ CQ CQ CQ CQ DE W9EHC W9EHC W9EHC K

I personally use ditdit ditdit between the sections of the call. Most stations merely *pause* before a repetition of a call sequence. It is *not* proper to use the "fractional bar," the "break," or the "understand" signal or SN between the identifying call sign and the next CQ group. Note that only the "go ahead" (K) signal follows the call; *do not* use the "end of message" (AR) signal here; nor should one be guilty of the hiddism of sending "HW?" However, it is very good form to end up something like this: . . . W9EHC ORS COLO QHM K — meaning that the station is an Official Relay Station located in Colorado and that the operator will tune from the high-frequency end of the band to the middle of the band. These signals give the listening operators some definite information that aids in making a reply. The "ORS" means that the

\*SCM Colorado, 819 East Dale St., Colorado Springs, Colo.

station is reliable and will handle traffic; the "COLO" means that the station will handle traffic for that state with a minimum loss of time; the QHM means that if the other operator's frequency is in the low-frequency end of the band, he need not waste time calling. Send your CQ at a speed no faster than you can copy solid, for the answering operator will reply at the same speed you use, unless he is otherwise instructed. The A.R.R.L. operating booklet reads (on the subject of calls) as follows: "The general inquiry call (CQ) should be sent not more than five times without interspersing one's station identification, and the length of repeated calls carefully limited in intelligent amateur operating."

### 3. The contact:

After you have contacted the other station by answering its CQ, having your CQ answered, or by scheduled calls; it is not necessary to make a long call; each station has its receiver tuned to the other's frequency, and calls can be very short — W9FXQ DE W9EHC — or else omitted. Just remember that you must sign your call at least once every ten minutes or at the end of every transmission (after the SK).

In the context of the first transmission after contact is effected, there is considerable variation. However, there are a few fundamentals to be observed. The call should be separated from the context by a "break" signal (BT): W9FXQ DE W9EHC BT R TNX FER THE CALL OM RST 579X QTH COLORADO SPRINGS COLO BT QRK? QTH? QRU? AR W9EHC K or: W9FXQ DE W9EHC BT R GLAD TO MEET U OM RST 579X HR IN COLORADO SPRINGS COLO BT QTH? QRU? AR W9EHC K. One can separate his thoughts into paragraphs by insertion of BT at appropriate intervals. Note that it is not at all necessary (nor is it good form) to send "UR SIGS" before the RST report. It is a matter of politeness to give the other operator a conversational lead during your transmission — an inquiry about his rig, location, occupation, weather, etc. Do not make your transmissions too cut-and-dried — try to be original, but do not violate good taste while doing so. If you run out of something to say, don't send a series of BT's; send a wait signal (AS), or conclude your transmission.

### 4 The sign-off:

Make this snappy, crisp, and positive. Don't fool around and let the sign-off take up several exchanges. After you send SK, don't come back to the other station with anything more than a "ditdit" to let him know that you heard his sign-off. Here's a sample sign-off: . . . WL OM I HV TO QRT AND GET OFF TO WRK TNX FER THE PLEASANT CHAT AND LOOK FER ME AGN TMW AM AT ABT THIS TIME CUL 73 SK W9EHC.

### 5. Message handling:

This is one of the most important phases of amateur activity and also one of the most neglected. Few operators use correct procedure in dispatching traffic. Here are a few pointers:

- A. Accept only messages having complete addresses.
- B. Limit messages to reasonable length.
- C. Use the standard ARRL-AARS message form: Number, Station of Origin, Word Check, City and State of Origin, Hour of Filing, Date, Name and Address, BT, Text, BT, Signature, AR. This may be followed by QSL? especially if the recipient is slow in making proper acknowledgment of receipt. Do not use BT in any place in the radiogram other than the two spots indicated. Do not use any abbreviations or punctuation marks in the text of the message. Spell out all numerals.
- D. Do not send each word twice unless requested.
- E. Send "?" after difficult or unusual words and repeat the word. Send "?" after one-letter words (L, A) and repeat the word.
- F. Use ?AB, ?AA, ?WA, ?WB, ?BN, ?PBL, ?ADR, ?TXT, ?SIG to get fills.
- G. Never send "R" unless you have received the message absolutely perfectly and completely.

H. Send slowly enough so that the receiving operator can copy you solid and not have to waste time getting fills. Get your high-speed code practice at some other time.

### 6. General:

- A. Strive to send smoothly, even if it means slowly. Make your dots heavy. If you use a "bug" key, set the dot speed so that they are sent in the correct proportion — a dot should be  $\frac{1}{2}$  the length of a dash, not  $\frac{1}{6}$ , as some lads think. Adjust your dot contact so that your plate milliammeter reads one-half its key-down reading when you send a "5."
- B. Do not use
  - QSL for QSL
  - QRA for QTH
  - 73's for 73
  - Best 73 for Vy 73
  - 88's for 88
  - BT for AS or II
 Use all abbreviations only for the meanings for which they are intended.
- C. Never omit the prefix or numeral of a call. It is illegal as well as silly. (Radiotelephone operators especially should be careful to identify their stations by stating each call letter separately. Not W NINE TRIPLE X but W NINE X X X. It is unlawful and the subject of F.C.C. citations to not give each call letter properly.)
- D. Never send faster than you can receive.
- E. Unless you are a member of the AARS or the NCR, do not use "V" as an intermediate.
- F. When you make a mistake, send the erasure signal (eight dots) and repeat the last word sent correctly and then proceed at the same (or a slower) speed.

— . . . —

## Section Nets Urged to Use "160"

It has been the practice of A.R.R.L. for some years to "register" the frequencies of all operating amateur nets, inviting inquiries from Route Managers, Phone Activities Managers and others, and advising all concerned promptly by advice on frequencies in use, so that all conflicts between Trunk Lines, and A.A.R.S. and N.C.R. or other group frequencies might be avoided in advance choices insofar as possible, and by time-of-operation changes, to avoid mutual QRM. There may be room for one or two spot-net operations, at unusual hours on the 3500-4000 kc. band, in addition to existing nets, but from a practical standpoint, the c.w. sectors of the band at least at "full up."

Therefore *this is to recommend* that new Section Nets and those contemplating moving net operation, for QRM or other reason, should consider selection of a suitable 1715-2000 kc. band frequency for spot-frequency work. The band is ideal for consistent local coverage. As one man reports, "Any 3.5-Mc. antenna, a single 6L6, and crystals ground to a 1.8-Mc. frequency will enable our netters to put a good strong signal into any part of our state." A.R.R.L. will continue to record the frequencies of all operative nets and give such advice as possible to those planning traffic and net operations.

— . . . —

The Kentucky Section is first to set the example by a move to the 160-band. It's from practical Kentucky operations that we are advised, as above, that a 6L6 and a new rock will do the job. W9BAZ adds this interesting comment: We call ours the Rebel Net, first because of the historical significance, we chose 1776 kc. for our frequency, and second because it's a revolutionary (albeit sensible and much-needed) move, going from the 80- to the 160-band.

— . . . —

WOWO Cottage, Lake George, Indiana, was the convention center, Sept. 4th and 5th, for the Coca Cola Net members who operate on 3928 kc. Among those present were W8CVZ, W8IP, W8GPS, W9AAI, W9HLO, W9EEV, W9BJE and W9SLW. Many YL's and XYL's were also with the crowd for this gala occasion.

# WIAW Operating Schedule

## OPERATING-VISITING HOURS

3:00 P.M.—3:00 A.M. E.S.T. daily, except Saturday-Sunday.

Saturday — 8:30 P.M.—2:30 A.M. E.S.T.

Sunday — 7:00 P.M.—1:00 A.M. E.S.T.

OFFICIAL BROADCAST SCHEDULE (for sending addressed information to all radio amateurs).

## Frequencies

C.W.: 1762.5—3825—7280—14,254—28,600 kcs. (simultaneously)

Starting Times (P.M.)		Speeds (W.P.M.)								
E.S.T.	C.S.T.	M.S.T.	P.S.T.	M	T	W	Th	F	Sat	Sun
8:30	7:30	6:30	5:30	20	15	25	15	20	—	20
Midnight	11:00	10:00	9:00	15	25	15	20	15	15	—

PHONE: 1806, 3950.5, 14,237, 28,600 kcs.

Each code transmission will be followed in turn by voice transmission on each of the above frequencies.

## GENERAL OPERATION:

Besides specific schedules in different bands, WIAW devotes the following periods, except Saturdays and Sundays, to GENERAL work in the following bands:

Time, E.S.T.	Frequency
4:30 P.M.—5:00 P.M.	28,600 kc. Fone/CW
6:00 P.M.—6:30 P.M.	14,237 kc. Fone
6:30 P.M.—7:00 P.M.	14,254 kc. CW
8:00 P.M.—8:30 P.M.	14,254 kc. CW
9:30 P.M.—10:00 P.M.	3950 kc. Fone
10:00 P.M.—10:30 P.M.	14,237 kc. Fone
11:30 P.M.—12:00 A.M.	1762/1806 kc. CW/Fone
1:00 A.M.—2:00 A.M.	3825 kc. CW
2:00 A.M.—3:00 A.M.	7280 kc. CW

7:00 P.M.—8:00 P.M. Skeds on 80 meters.

10:30 P.M.—11:30 P.M. Nat'l Trunk NCS 3670 kc.

Effective Nov. 1, 1939

At other times, and on Saturdays and Sundays, operation is devoted to the most profitable use of bands for general contacts and to participation in special week-end operating activities. The station is not operated on legal national holidays.

Give WIAW a call for an accurate frequency measurement, to communicate with any department of A.R.R.L., to rag-chew when time permits, or to pass a message to ham friends in other places or on other bands.

WIAW is installing what may be amateur radio's largest oven for temperature control of crystals, preparatory to starting a schedule of Marker Frequency Transmissions near amateur-band edges. Three of the eight special Bliley BC10 units are shown in front of the thick balsa wood oven to which the General Radio temperature-control equipment will be attached. The control oscillator is in the 1/8" aluminum double-box.

This control unit will be located in one of the completely enclosed racks, near the G.R. 100-ke. standard. From this box a "battery" of 807 frequency doublers feeds the control and exciting r.f. voltage, through links to each of the 1000-watt transmitters. The Headquarters station schedule of Marker Frequency Transmissions will be announced as soon as adjustments of the frequencies are completed for all bands.

# Brass Pounders' League

(August 16th—September 15th)

Call	Orig.	Del.	Rel.	Extra Del. Credit	Total
W3EML	114	290	1174	273	1851
W4PI	15	110	1608	99	1832
W7EBQ	0	0	1701	0	1701
W6IOX	41	109	1258	104	1512
W5FDR	36	144	1058	136	1374
W9QIL	129	194	798	182	1303
W6PCP	107	347	407	308	1169
W5MNN	32	120	494	119	765
W6IMI	24	165	261	163	613
W3CIZ	52	138	222	136	548
W6LLW	26	45	428	20	519
W4FDT	24	33	419	33	509
W3BWT	35	44	388	36	503

## MORE-THAN-ONE-OPERATOR STATIONS

Call	Orig.	Del.	Rel.	Extra Del. Credit	Total
KA1HR	585	539	400	0	1524
W8JUQ	355	355	0	335	1045
KA1HQ	206	136	562	104	1008
K5AA	334	123	40	110	607
W2SC	22	107	292	103	524

These stations "make" the B.P.L. with total of 500 or over. One hundred deliveries + Ex. Del. Credits also rate B.P.L. standing. The following one-operator stations make the B.P.L. on deliveries. Deliveries count.

W6NLL, 390	W2HMJ, 131	More-than-one-opr.
W7APS, 291	W6BIP, 130	W5OW, 137
W6LUJ, 273	W4ADB, 113	WIAW, 129
W3QP, 254	W9ZFC, 111	
W1KH, 132	W9QXO, 106	

A total of 500 or more or 100 deliveries Ex. D. Cr. will put you in line for a place in the B.P.L.

## Puerto Rican Certificate Available!

The Puerto Rico Amateur Radio Club will issue a CERTIFICATE to every amateur having worked twenty-five (25) K4's.

Send complete sets of 25 K4's verification cards with only enough return postage and this certificate will be yours by return mail. Address all communications as follows:

Puerto Rico Amateur Radio Club,  
P. O. Box 15,  
HATO REY, Puerto Rico

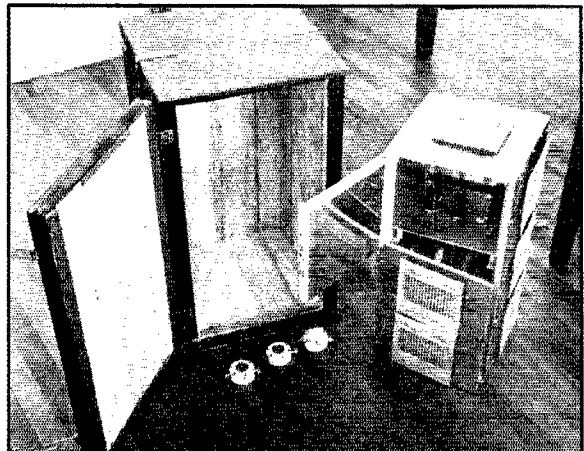



# How's DX?



## HOW:

**T**HAT crack we made last month about changing the name to "Where's DX?" isn't very funny about this time, what with the pickings getting slimmer every day and the answer coming back "What DX?" But carry on, ladies, and we'll tell you what the gang has been doing, if at all.

First, though, let's take a look-see at the set-up across the drink and elsewhere. The OZ's were closed down on October 1st, and HH has been off since September 13th. CO-CM, reported off last month, are expected back on shortly — their absence is explained by the fact that the regulations are being revised down there and new licenses will be issued. We have heard a rumor that all HB's have been called into service. W1EH worked D4BVJ the second week in September and was told that not all D's had had their licenses "taken in" but that it was expected — more surprising was the information that ex-OE and ex-OK amateurs were being issued D calls, but in Slovakia OK calls still stand.

One PJ, writing to explain why he is off the air, says, "Transmitting is not allowed in time of peace, but now I want to obey the laws of my country." That's not a bad thought, you know. We W's have to do just the same thing, particularly in observing this neutrality stuff. As Jeeves and I see it — and we've just had a long talk — as hams all we have to do to remain neutral is to keep our noses out of other peoples' business. For those that don't know how to do that, it simply means that, over the air, we don't ask and we don't tell. In other words, we become perfect DX men, in a routine sort of way, and ask only for reports, QSL's, dope on rigs, and give out only the same. Also, because we have a hunch that there are a lot more ears on the air now, we are more careful than ever about observing all of the laws. If no one is impressed by our fine conduct on the air it isn't because we haven't tried, is it?

## WHERE:

**C**REDIT for the *coup DX* of the month goes to W2BHW and W2GVZ for knocking off AC4JS (14,400 T9), right under CE3AG, one evening around 7 P.M. The fellow is sure enough in Tibet and is even DX for W6GRL. First thing you know, the TWA (Tibet Workers of America) will need a bigger club room. While we're on the subject, W9HLF, prey of the TWA, tells us the society is branching out to include chapters in Guam (TWG), China (TWC), KA (TWP), etc. . . . . HX2GK was in Switzerland . . . . . KB6RWZ (14,385 T9) is taking over KB6ILT, according to W1WV, but W9HLF tells us that ILT, RWZ and KB6RSJ (14,385 T9) take turns using RWZ' new receiver, and that ILT is going on 'phone soon . . . . . W7AYO gives the address of MX3H (14,300 T9) as Sakae Taboga, P. O. Box 30, Shinkyoo, Manchukuo. Incidentally, all MX cards can go there for QSP . . . . . ZL2JQ

fooled us again, this time with ZX1A off South America . . . . . W1IBF tells us that, until further notice, all HK's must conduct all QSO's in Spanish. We don't know if this carries over to c.w. and the RST/Q-code type of conversation, but you'd better brush up on your *habla*, just in case . . . . . This YI6ZC (14,390 T7c) has been giving the boys a time. No, we don't know either . . . . . W2IYO will be glad to QSP your cards to TF3MX (14,350 T6) who QSL's . . . . . W2AV heard AR8MO (14,315 T9) working J2GX the other morning, but couldn't raise the guy when he finished. Did anyone ever get a card from AR8MO? . . . . . W1RY worked a TAIAR (14,320), who said he was in Smyrna, QSL via SV1RX. Another "wonder" boy, if you ask us.

## WHEN:

**T**HE 7-Mc. band still gives them up to those who dig, W6OAN working LU1EP (7200 T8x) and LU9AX (7210 T8x), and hearing LU9VA (7005 T8x), CE3EE (7300 T9x), YVIAD (7190 T9x) and HK2BL (7200 T8). LU1EP was also worked on 3500 kc., on sited . . . . . W3ATR adds HCIAZ (7120), HKIAP (7145) and PY6AG (7140) . . . . . KA1HQ reports KF6QMQ (7095), HK5ED (7085), PY4DL (7090), W5HLK (7130) and lots of J8's and XU's.

On 20, W1KHE starts things with OQ5AU (14,400 T9), OX7ZL? (14,310 T6) and CR6AI (14,380 T5) . . . . . W8RTU has a few, including TF5M (14,320), OA4J (14,400), SV1RX (14,400), U4AM (14,330), UIAD (14,400) and IIR (14,400). W6RWX (14,320) is a new one on in Nevada . . . . . W8QQE, summering at a lake instead of simmering in town, scared up a few with a hay-wire antenna which include KAIHR (14,275 T8c), KA7EC (14,350 T9), XU8MI (14,360 T9), CRTAL (14,260 T9), KAILZ (14,255 T9), PK4FS (14,340 T9), KF60WR (14,390 T9), KAIWW (14,350 T9), XU8WS (14,375 T9), KAISP (14,395 T9), KAIFG (14,360 T9) and KAIER (14,340 T9) . . . . . W9NTA contributes J8CA (14,400 T9), CR7BN (14,320 T9), YN9G (14,400 T7) and J2KN (14,400 T9) . . . . . W2GVX/1 adds ES2C (14,300 T9), EN5D? (14,345 T9) QSL via W3EDP, HCLAR (14,320 T4), U8IB (14,400 T9) and PK3ST (14,320 T9) . . . . . W5HQN has LAIRA (14,350 T9), UK3AH (14,400 T9), USBM (14,400 T6) and IIMQ (14,320 T9) . . . . . W2BHW just doesn't believe DX can ever be scarce, and proves his contention with a mile-long list which includes such notables as MX1A (14,400 T9), XU6AC (14,380 T8), XU5HR (14,320 T7c), XU6UK (14,300 T8), J8CL (14,370 T9), TC9BA (14,280 T9), KAIPO (14,360 T9), J2PK (14,345 T7), PKIXZ (14,260 T9) and J6DN (14,290 T8c). Heard but not hooked were PK5AB (14,310 T8), J8PG (14,350 T7c), XU6W (14,335 T7), PK1XB (14,255 T9), and XU8A (14,360 T8) . . . . . W3DPA has ZP2AC (14,400), K7GOR (14,300) and PKITM (14,400), while W2AV adds UK6WA (14,400 T7).



The rig at VU7BR is a 6L6-807 job running at 28 watts input. The 807 acts as a doubler on either 20 or 10 and, through a matching network, feeds a Zepp with a 206-foot top. The receiver is an HRO.



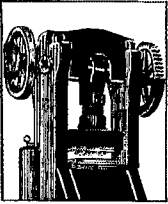

DANA BACON's article in last month's *QST* on his noise limiter has caused a lot of interest, judging from our mail. One amateur reported that he had installed the limiter in his receiver, and it worked FB. He must have stayed up nights doing it, for his letter was postmarked only a few days after *QST* appeared.

However, installing a limiter is not a task to be undertaken lightly, and we do not recommend that you attempt it unless you have excellent laboratory equipment and plenty of experience. The difficulties are not just with the noise limiter itself. The performance of the receiver is apt to suffer in other respects when the changes are made unless care and skill are used.

All new receivers of the NC-100 series will be equipped with the new noise limiter. We will install it in older receivers of this series at the factory for a nominal price. Just when this can be done, and what the price will be, we cannot say at this time. We will let you know shortly.

What with the World's Fair and all, we have had a lot of visitors at our plant this Summer. They are always very welcome, and we hope that any amateurs who find themselves near our plant will drop in to see us. As a matter of fact, you can get a pretty good bird's eye view of radio manufacturing within our plant, because we make many of the parts we use. This includes almost everything except tubes, resistors and bypass condensers.

If you have any curiosity as to how bakelite moldings are made, or how a high speed winding machine puts the coils on an R-100 choke, this is a golden opportunity to find out. If you want to see a power press blank out the chassis of an NC-100 at a single blow, there it is. If you have wondered what we meant when we said every receiver had laboratory test and alignment, you can see for yourself. You can see the whole works, from research laboratory to shipping room.

You have probably gathered by this time that we are rather proud of our plant. Sure we are. We remember when it was one room about 20 by 20 feet. That was twenty-five years ago (October was our 25th Anniversary). We did not make radio equipment at first, but we were in it among the first. Remember the old Velvet Vernier dial (still going strong) and the DX condenser? Since then, steady growth has brought many changes, and we would like to show you what we have. One reason is that we are proud of it. The other is that we think it will give you a new respect for National Products to see how they are put together.

W. A. READY



# For the Finest in Switches it's MALLORY-YAXLEY

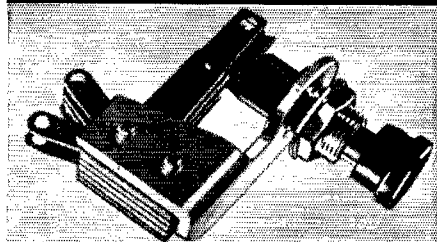

Yaxley Push Button switches are ideal for meter shunt service, as well as for set analyzers, tube checkers and other test equipment.

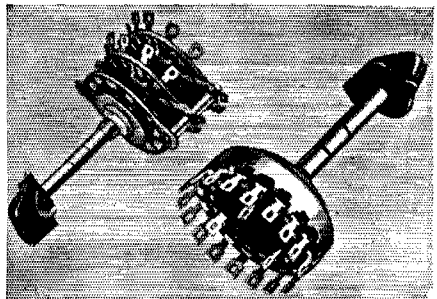

Here are just two of the many types of switches perfected by Mallory-Yaxley. Each type offers outstanding advantages for circuit application.

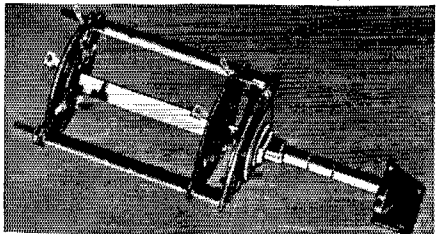

This Mallory-Yaxley Hamswitch No. 151L permits the use of a single meter to measure currents or voltages on up to and including five circuits in an amateur transmitter.

**P. R. MALLORY & CO., Inc.**  
INDIANAPOLIS INDIANA  
Cable Address—PELMALLO

Use

P. R. MALLORY & CO. INC.

**MALLORY**  
APPROVED RADIO  
PRECISION PRODUCTS

Use

**YAXLEY**  
APPROVED RADIO  
PRECISION PRODUCTS

## WHAT:

ONE has to be very careful these days before accepting an idea. For example, W3DPA suggests something that, at first glance, looks like a swell thought. Jack thinks it would be a fine thing if we all got together on a "National Non-CQ Week" in the DX bands. This would mean that no W would call CQ on 10 or 20 (we couldn't hope for such a thing on 40!) during that week. Lots of talk has been made about the folly of calling CQ DX, but this would bring it home to those fellows who have been guilty of the waste of time, since they'd have to listen for a change and then they'd begin to work the stuff.

We're against it! Why should we cut our own throats? If the poor guys want to pass up the DX by calling CQ all day long, let them do it. It would just make it tougher for the rest of us if some of those CQ-hounds ever got wise to the fact that they could work ten times as much stuff if they'd listen and call instead of call and listen. If they're too dumb to realize it, we aren't going to tell them. As a matter of fact, Jeeves and I call CQ DX every once in a while, just to throw the others off the track. Say — maybe that's the way. Let all the DXCC gang keep the air filled with "CQ DX" — then the others will think that's the way it's worked and they'll never listen, leaving all the choice stuff to us old smarties who have been sneaking a listen all the time.

## 'PHONE:

WILIG reports K6ACG (3988) coming through consistently around 6 a.m., and XE2FC (3004) around midnight, for those who hunt it on 75 . . . . 10 is picking up, and first evidence for the defense is submitted by W6PQW and his QSO with J2KN (28,760). Further evidence is presented by W1WV, who reports K4AOP, K4FOW, ZS5CD and ZS4AA. W1EH also reports South Africans coming through very well on 28 Mc.

W8LFE has some swell dope on 20, with stuff like C1BA (14,035), OQ5AA (14,080), Z55O (14,050), ZS6DY (14,080), YR5VV (14,400), EA7BB (14,140) CR6AF (14,210), YU7BJ (14,400), ZS6AD (14,070), J2KN (14,080) and J5CW (14,075) all tucked away. Heard but not glommed on to were IIMZ (14,080), KA7EF (14,095), PK4KS (14,035), PK1RI (14,020), IIPB (14,100) and K7HCX (14,210) . . . . W2IEV says that the F8GO you heard on, after all the F stations had quit, was really quite OK, having been given special permission by the government to police the band over there. Lew says there is a n.g. FN1C on the air . . . . W1AKY has been knocking it over, too, with ES4C (14,080), OQ5RT (14,035), CX2BK (14,115), HA3B (14,100), IITKM (14,015) and others in the bag. Ed would like to see more dope on 'phone in this pillar, duplicating our sentiments exactly, only we have to depend on others sending in the stuff and, no sendee — no seehee . . . . W1ADM was in the other day, and tells of ES5D, ZS6AJ and YR5PB being worked and J5CW and PK1OG heard. Speaking of firsts, which we are now, Carl has a card from CT2BP that was sent air mail on the first mail-carrying flight of the American Clipper.

## WHO:

W6QD plans to go through with the November DX Contest in spite of some of the countries being inactive. It should be an interesting contest, since this is the first time that a major one has come around at this time of the year. The dates, you know, are November 25th-27th and December 2nd-4th, starting and ending at 02 GT. But don't send your logs to us — send them to Herb and make sure they are postmarked not later than December 15th. Good luck men . . . . In case you didn't get a card from HR4AF and want HR credit for the DXCC, we have his logs. He's through down there . . . . W5KC ran up a 38-minute WAC, working OZ2AU, ZS1Z, J6CD, W7FMP/7, KA1FG and PY1FM in that time one morning around 2 . . . . K4FCV is up to 104 countries, U9AW giving him his latest . . . . HP1X tells us he's through down there, but the lads will all get cards in time — if they have patience. He's shutting down because of conditions, and he doesn't mean weather! . . . . XU8MI, via W1AB and W1APA, says to please ask the gang to lay off breaking up his QSO's with the e.c.o.'s. He tries to work as many as possible, but the silly calling on top of a station he's working just slows up everyone. 8MI has lost several important messages because he hasn't been allowed to finish. We could put in our two cents' worth regarding what we think of monkeys that bust

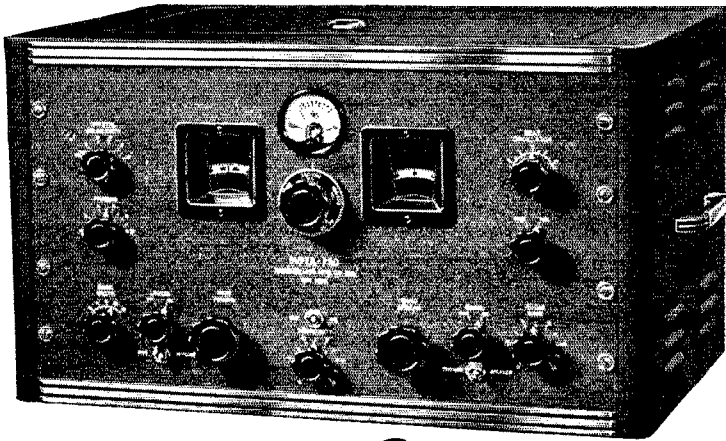

# NEW SUPER PRO

**FULL RANGE** *"Selectivity"*  
*Single signal to* **HIGH FIDELITY**

**H**IGH SENSITIVITY in a communications receiver is only usable when the proper degree of selectivity is also available. If selectivity is not sufficient, no amount of sensitivity will permit satisfactory reception. Here, the new Series 200 "Super-Pro" stands supreme. The extremely high sensitivity available in the "Super-Pro" is always usable because of the continuously variable selectivity characteristics. The I.F. band width control varies the selectivity from approximately 3 kc. to 16 kc.; in addition to this feature, the variable selectivity crystal filter permits the selectivity to be varied from  $2\frac{1}{2}$  kc. down to better than 100 cycles. The operator can adjust the selectivity of the new "Super-Pro" to a point where interference is reduced sufficiently to permit reception of the desired signal. This optimum point of selectivity permits the greatest possible fidelity without interference. The selectivity of the I.F. amplifier in the new "Super-Pro" is varied by mechanically changing the coupling between the primary and secondary of the I.F. transformers. This method provides a smooth control of selectivity.

In addition to the above features, the operator of a "Super-Pro" has available such other refinements as: noise limiter; continuous band spread; an AVC system designed for greatest effectiveness; a new adjustable "S-Meter"; two stages of tuned radio frequency amplification which practically eliminate images, and many others. If you want the best, get a "Super-Pro".

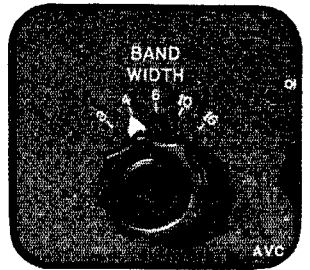
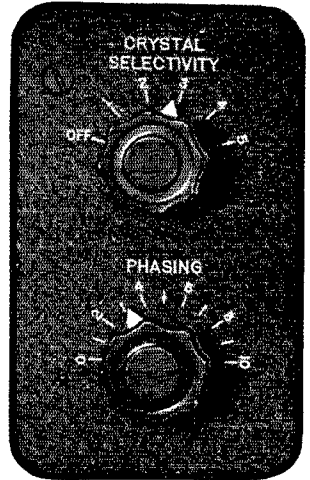

Above: Three important selectivity controls. The use of these controls permits the operator to adjust the band width of the receiver to conform with receiving conditions.

MAIL COUPON TODAY →

HAMMARLUND MFG. CO., INC.  
424-438 W. 33rd St., N. Y. City  
Please send New "Super-Pro" Data.

Q-11-39

Name.....  
Address.....  
City.....State.....

Canadian Office: 41 West Ave.  
No., Hamilton, Ont.



# HAMMARLUND



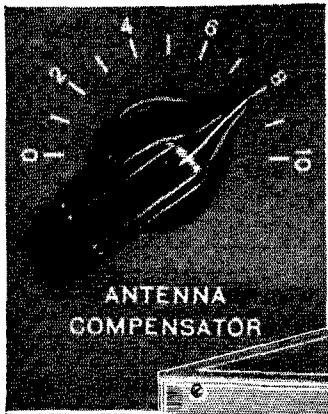

ANTENNA  
COMPENSATOR

*You're always* **"IN TUNE"**  
*with an*  
**HQ-120-X**



9.7-555 METERS

THERE'S a good reason for the high signal-to-noise ratio in the "HQ-120-X". The first tuned circuit of any receiver controls the signal-to-noise ratio. When an antenna is coupled to this very important circuit, there is usually a detuning effect. This detuning effect lowers the signal-to-noise ratio. The antenna compensator on the "HQ-120-X" provides a control for restoring resonance, regardless of the effects of the antenna system. In high gain, highly selective circuits this control becomes a necessity if peak performance is to be had. Try an "HQ-120-X" and note its superior signal-to-noise ratio.

An improved highly efficient noise limiter; accurately calibrated main dial; band spread dial calibrated for 80, 40, and 20 meter amateur bands; sensitive "S-Meter" and variable selectivity crystal filter are a few of the other features which have made the "HQ-120-X" one of amateur radio's most popular receivers.

WRITE FOR BOOKLET

HAMMARLUND MFG. CO., INC.  
424-438 W. 33rd Street, New York City

Q-11-39

Please send 16-page booklet

Name .....

Address .....

City.....State.....



Canadian Office: 41 West Ave.  
No., Hamilton, Ont.

**HAMMARLUND**

# Europe "Clears thru" CENTRALAB

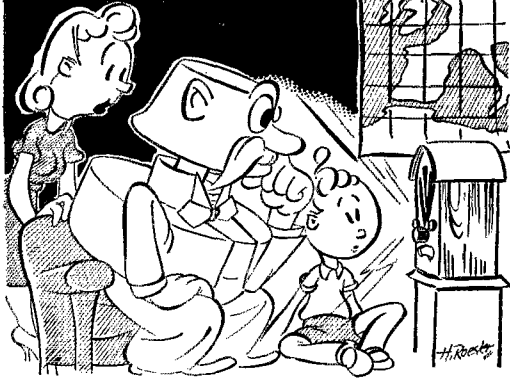

● Short wave reception really means something these days . . . and when it is a bit "frazzly" on the higher frequencies the Radio Serviceman comes into his own. The wise brothers carry Centralab "spares" for satisfactory replacement service, and please the most critical cash customers. So, if you would glean the golden harvest these days . . . see your jobber for sufficient Centralab replacement parts.



## CERAMIC CAPACITORS

Where permanence of temperature compensation insure and retain stability of frequency in oscillator circuits.

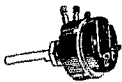

## VOLUME CONTROLS

In standard or midset . . . a low noise level and smooth attenuation insure reception of faint signals.

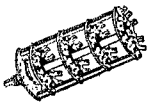

## WAVE CHANGE SWITCHES

Multi-point switching for wave change or tone control . . . with positive low resistance contact.

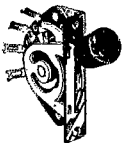

## TOGGLE SWITCHES

In communication receivers . . . with crystal filters and wherever delicate supplemental tuning is involved.

# Centralab

DIVISION OF GLOBE UNION, INC.  
MILWAUKEE, WISC.

put the signals over. W9WYX made two three-element Yagi beams for Don and Al that could be set up in two minutes' work. Then after building a 6-element Yagi (five minutes to set this up), he built a new 112-Mc. rig like that described by W5CSU in July *QST*.

At 5 A.M., August 19th, the HK24's were on the road to Genoa with the XYL, while W9VTK and his XYL started for Mt. Evans, 14,460 feet high. A series of schedules were to be kept, and Don of W9CKO (on a trip to South Dakota) was also to participate at 250 miles, if possible. Through the courtesy of Mr. C. W. Gregory of Genoa, who is most glad to cooperate with radio amateurs in permitting use of his excellent 60-foot tower, W9WYX set up the Yagi, running feeders from the antenna to the truck on the ground, getting on just in time for number one sked at 8.30 A.M. A call — a minute of suspense — and the answer from W9VTK.<sup>1</sup> S3 sigs became S9 with a slight adjustment! A "solid" QSO for two hours followed over the 120 miles, Al with his mobile rigs retransmitting to W9VCC and VGC in Denver. "We're all set to try 1¼ meters from the same spot soon," says W9WYX.

<sup>1</sup> W9VTK's rig is registered in the A.R.R.L. Emergency Corps. Power is from Vibrapacks to 42-0V6G-307 for frequencies below 112 Mc. W9WYX's lineup is powered from a gas-driven generator mounted permanently in a Chevlie truck, 6L6-807-809-809's, substituting HK24's P.P. on 2¼ and 1¼ meters. "Bob" is an A.R.R.L. Official Phone Station appointee and a credit to the A.E.C. Mr. Gregory's tower, according to Ripley, can be used for spotting points in five states. There's power up in the tower, too, and Mr. Gregory extends invitation to other u.h.f. experimenter-hams to set up there for test schedules, from Genoa, Colo.

## A.R.R.L. HEADQUARTERS OPERATORS

Hal Bubb, "Hal," Stn. Eng. and Chief Opr. W1AW  
George Hart, "Geo," 2nd Opr.

The following calls and personal signs belong to members of the A.R.R.L. Headquarters gang:

- W1AW, A.R.R.L. Headquarters
- W1BAW, R. T. Beaudin, "rb"
- W1BDI, F. E. Handy, "fh"
- W1CBD, C. B. de Soto, "de"
- W1DF, George Grammer, "gg"
- W1EH, K. B. Warner, "ken"
- W1ES, A. A. Hebert, "ah"
- W1GS, F. C. Beekley, "beek"
- W1INE, A.R.R.L. Headquarters Operators Club
- W1JEQ, Vernon Chambers, "vo"
- W1JFN, A. L. Budlong, "bud"
- W1JMY, Joseph A. Moskey, "joe"
- W1JPE, Byron Goodman, "by"
- W1JTD, Hal Bubb, "hal"
- W1LJI, Thomas M. Ferrill, Jr., "tom"
- W1LVQ, L. John Huntoon, "jh"
- W1MEC, W. J. Fricke, Jr., "bill"
- W1MFA, Harold K. Isham, "hi"
- W1SZ, C. C. Rodimon, "rod"
- W1TS, Don Mix, "don"
- W1UE, E. L. Battey, "ev"
- W3AMR, George Hart, "geo"

## O.B.S.

The following is a supplement to the list of A.R.R.L. Official Broadcasting Stations in October *QST* (page 76): W1EAW, W1LMB, W2EKU, W2JLQ, W3BIW, W3FMR, W3GNM, W3HFD, W3HWJ, W4AXP, W4BJF, W4CUE, W6AM, W6BBR, W6ITH, W6KKL, W6KNZ, W6KYO, W6RIU, W6Tt, W7AYO, W7CZY, W7GNJ, W9TBF, W9ZIZ.

At a recent radio club meeting Emil Felber, W9RH, and Doc Meeker, W8ADV, both letter carriers for Uncle Sam, discussed the fact that they had each worked other hams who were letter carriers. They would like to have a line from as many mail-carrier radio amateurs as possible, giving frequencies and operating hours, so radio skeds for all perhaps can be passed around to the whole group.

(Continued on page 80)

# new "HFB" condenser with INSULATED ROTOR

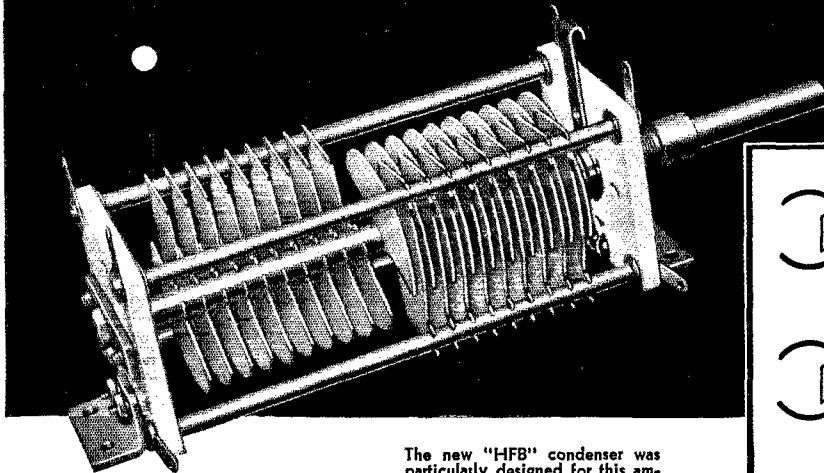

The new "HFB" condenser was particularly designed for this amplifier circuit. The "HFB" in this circuit permits the use of higher plate voltages for a given condenser plate spacing.

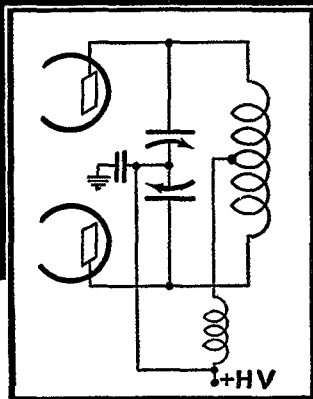

THE new Hammarlund "HFB" condenser offers the amateur a solution to many difficult problems. The "HFB" is radically different in design from the usual transmitting condenser. The use of Isolantite end plates and an insulated control shaft provides greater personal safety to the operator and permits the use of higher circuit voltages for a given plate spacing. This new condenser was especially designed for the circuit shown in the illustration. This circuit was introduced by Ferrill in December 1938 "QST".

All superfluous metal framework has been eliminated in the new "HFB" making it ideal for high frequency operation. Losses are reduced to a minimum through the use of soldered brass plates, cadmium plated. There is no staking, riveting, or clamping to introduce the

danger of high resistance contacts . . . every joint is securely soldered. The compactness of the "HFB" is another of its many desirable features. The "HFBD-65-D," illustrated, is only 5" long x  $1\frac{13}{16}$ " square, and is suitable for use in circuits with 3,000 volts applied to the tubes.

See page 38 of October "QST" for an amplifier using the new "HFB". Our 1940 catalog describes a complete line of these new condensers.

## MAIL COUPON TODAY!

HAMMARLUND MFG. CO., INC.  
424-438 W. 33 St., N. Y. City

Q-11-39

Please send "1940" Catalog

Name.....

Address.....

City.....State.....



Canadian Office: 41 West Ave.  
No., Hamilton, Ont.

# HAMMARLUND





40 EDITION OF THE

AMATEUR'S

BOOK

IS READY!

\$1 POSTPAID  
\$1.25 OUTSIDE OF  
CONTINENTAL U.S.A.

# CATHODE MODULATION

KENYON takes pleasure in offering a series of three low price CATH-ODRIVE modulation transformers. These new and extremely flexible units are designed to match 6V6's, 2A3's, 6L6's, etc. to various class "C" loads between 40 and 3,000 ohms. Impedance matching is not critical and a rather wide variation from the above values will give satisfactory results. This new method of economical modulation was described in the October issue of Radio and should be attractive to those amateurs who have long wished to operate on phone but who have been held back because of the high cost of plate modulation.

Type	Max. Sec. D. C.	Audio Tubes	Amateur Net Price
<b>T-471</b>	200 M.A.	Single 6F6	<b>\$2.40</b>
<b>T-472</b>	300 M.A.	PP 6V6 or 2A3	<b>3.00</b>
<b>T-473</b>	450 M.A.	PP 6L6's — AB <sub>1</sub> or AB <sub>2</sub>	<b>3.60</b>

Send today for complete sheet showing various combinations possible and complete technical information. Catalog free upon request



**KENYON**  
 TRANSFORMER CO., INC.  
 340 BARRY STREET - NEW YORK, N. Y.  
 Export Department: 25 Warren St., New York, N. Y.

(Continued from page 76)

## MEMBERS, DX CENTURY CLUB

W6GRL.... 145	W1HX.... 115	W2BMX.... 104
G6WY.... 144	G5BD.... 115	G6KP.... 103
W8CRA.... 143	W9KA.... 114	W8KKG.... 103
W2GT.... 143	W2DC.... 114	J2JJ.... 103
W1TW.... 140	G5RV.... 114	W5CUJ.... 103
W2GTZ.... 140	W1AXA.... 114	VE3QD.... 103
W8DFH.... 139	W5KC.... 113	W9CWW.... 103
W6KIP.... 139	G2DH.... 113	W9NNZ.... 103
W9TJ.... 138	W8MTY.... 113	W4IO.... 103
W1SZ.... 137	G6CL.... 112	W3FQP.... 103
ON4AU.... 137	W6GAL.... 112	W4CBY.... 102
G2ZQ.... 136	W3EVT.... 112	W8AU.... 102
W2GW.... 135	W4CTU.... 112	W8OXO.... 102
W3EMM.... 135	W3FRY.... 112	W1FTR.... 102
W6CXW.... 134	W3GAU.... 112	W2BXA.... 102
W1TS.... 132	W2AAL.... 111	W1GDY.... 102
W8BTI.... 132	W1ADM.... 111	W1GNE.... 102
W4BPD.... 132	G5BY.... 111	W2AV.... 102
W1LZ.... 131	ON4UU.... 110	W3ZX.... 102
G6RH.... 131	PA0XF.... 110	F8RJ.... 101
W3VV.... 130	W2CJM.... 110	VK3KX.... 101
W8DHC.... 129	W6FZL.... 110	W4AJX.... 101
W2BHW.... 129	W2DSB.... 110	W6DOB.... 101
HB9J.... 128	W9UM.... 110	SUIWM.... 101
W5BB.... 128	W5QL.... 110	W8EUY.... 101
W8OSL.... 127	W3DDM.... 109	W1CC.... 101
W2CMY.... 127	VE2AX.... 109	SUISG.... 101
W8ADG.... 126	W2BYP.... 109	W6AHZ.... 101
W3CHE.... 126	W2GRG.... 109	W3KT.... 101
W9ARL.... 125	W6HX.... 108	W4MR.... 101
W2HHF.... 125	W8BKP.... 108	W6GHU.... 101
W1FH.... 125	W3BES.... 108	W2GNQ.... 101
W1DF.... 124	ZS2X.... 108	W9RBI.... 101
W2UK.... 124	W8IWI.... 108	G6NF.... 100
W3EPV.... 124	W1WV.... 107	W2AER.... 100
W9KC.... 123	W1DUK.... 107	W6KRI.... 100
W8LEC.... 123	W2CBO.... 107	W9UQT.... 100
W4CEN.... 123	G5BJ.... 107	G6MK.... 100
D4AFF.... 123	VK2DG.... 107	VE2EE.... 100
W8D WV.... 122	W7DL.... 107	W3BEN.... 100
W8OQF.... 122	W6MVK.... 107	VK2ADE.... 100
W2JT.... 122	G2TR.... 106	W8QXT.... 100
W8JMP.... 120	W1CH.... 106	ZL1GX.... 100
J5CC.... 120	W3AG.... 106	HB9X.... 100
W2GVZ.... 120	HB9BG.... 106	W9RCQ.... 100
W9GDH.... 119	HB9CE.... 106	W1ICA.... 100
W1BUK.... 118	W2OA.... 105	W1ZI.... 100
W3EDP.... 118	W4DRD.... 105	W8DOD.... 100
ZL1HY.... 118	G5QY.... 105	W6BAM.... 100
W9ADN.... 118	VK3CX.... 105	ZL1MR.... 100
W1JPE.... 118	G2ML.... 105	PA0QF.... 100
W9FS.... 118	W2IOP.... 105	W8BSF.... 100
W2ZA.... 118	VK3QK.... 105	D5BMP.... 100
W9PST.... 117	W4TO.... 105	W3AGV.... 100
W9TB.... 117	W1BXC.... 105	W8JTW.... 100
W7AMX.... 116	E1SF.... 104	W8HW.... 100
W3EVW.... 116	W1ZB.... 104	W4BYD.... 100
W6ADP.... 115	F8RR.... 104	W6KWA.... 100
W9EF.... 115	W6TJ.... 104	W8JAH.... 100
VK5WR.... 115	W6FZY.... 104	W1RY.... 100
W2CYS.... 115	W1BGY.... 104	Radiotelephone
W8NJP.... 115	W1GCX.... 104	W2AZ.... 102

The following have submitted proof of contact with 75-or-more countries: W4EQK, W8AAJ, W8LFE, W9AJA 99; VK6SA, W2ALO, W4CCH, W8QDU 98; G6GH, W2BJ, W2JME, W8LZK 97; W3GEH, W5ASQ, W8BOX 96; FELX, F8SAB, G6XL, W3EMA 95; W2CTO, W3AIU, W3A00, W8CJJ, W9BEZ 94; ON4CH, PA0QZ, W2WC, W6K7Z 93; SP1P, W3GHD, W4DMB 92; G8ZO, W3PLH, W3OP, W6TT 91; D2CSC, G6YR, LUTAZ, ON4FE, SP1AR, W1IOZ, W8KTV, W8PQQ, W9JDP 90; W8IQB 89; G2DZ, W3JM, W0PQS 88; G8IG, W9AEH 87; W1AVE, W1BGC, W4TZ, W9FLH, W9GJ 86; W1DOY, W4CFD, W6GK, W8LAV, W0VKT 85; SM6VL, W1BFT, W2CUQ, W6AM, W8BWB, W8DAE, W9OVU 84; OZ7CC, VE2GA, VK3HG, W2AWF, W2BZB, W2FLG, W6DTB, W6GPB, W6KUT, W8BFG 83; E14J, W1EWD, W3AYS, W8OUK 82; W9GY 81; BVK2T, W2ENX, W8BYN, W3EES, W6LDD, W8AAT, W8BWC, W8DGE, W9DIR, W9GMV 80; PY2DN, W2HTV, W3EUI, W8JFC, W9MRW 79; W1BPN, W3DRD, W8FIN 78; G3BD, LAZX, W4EPY 77; PA0JMW, W3BSB, W8ITK, W9GKS, W9HUV, ZE1J 76; W4AHF, W4OG, W8CED 75. Radiotelephone: W6OCH 94; G5RV, W2IXY, W4CYU 89; W2IKV 80; W1AKY, W8LFE 78; W1ADM 75.

## Oahu Outing

On Sunday July 23rd, the Oahu Amateur Radio Club held an outing at the home of Paul McGauley, K6DTT, in

# LOW! INCREASED RATINGS on RCA TRANSMITTING TUBES

The successful use of RCA Transmitting Tubes at far above their specified ratings is an old story to hundreds of experienced amateurs. Such "overloading" has been readily possible because RCA ratings were based, *not* on intermittent use, but on hard, constant operation in the world's most exacting commercial applications.

Now, thanks to the new "Dual Rating" system for many of the most popular RCA Air-Cooled Transmitting Tubes, you can take complete, fully-informed advantage of the big, extra measure of quality for which these tubes have long been famous. No guesswork. You simply choose the rating most closely approximating your own individual operating conditions and benefit accordingly.

This new RCA System recognizes that amateurs and many other users seldom operate power amplifier tubes under anything like the constant "key-down" conditions on which RCA Class C Telegraphy ratings have been based.

Two sets of maximum ratings are given for each tube, one designated as "Continuous Commercial Service" (CCS) and the other, much higher ratings, as "Intermittent Commercial and Amateur Service" (ICAS).

The CCS (continuous) ratings are essentially the same as the old maximum ratings. They are based on continuous, 18-hour-a-day-or-better service. The ICAS ratings permit much greater power input and a relatively large increase in useful power output for intermittent services. They take full account of the rapid progress in tube and transmitter design, and in tube manufacture and operating technique. ICAS ratings are suitable, for example, for use by the average amateur, who has his transmitter on the air not more than 300 hours a year.

Careful investigation of tube life under these higher ICAS ratings shows decidedly satisfactory results. A tube lasting several thousand hours at the CCS ratings may reasonably be expected to give in amateur service at least several years of trouble-free operation at ICAS ratings.

Thus, the new RCA Dual Rating System represents a big forward step. The new ratings pave the way for the finest tube buys on the market today. They are your keynote to low initial cost with maximum power output PLUS the utmost in real dependability.

## POWER TO FIT YOUR NEEDS . . . at Prices to Fit your Rig Budget !

These typical examples indicate the money-saving opportunities in the new ICAS (Intermittent) Class C Telegraph Ratings on popular RCA Tube types:



**802**—R-f amplifier pentode.  
Max. plate voltage, 600 V.  
Max. d-c plate input, 33 W.  
Grid driving power, 0.3 W.  
\$3.50 Amateur Net

**807**—Beam power tetrode.  
Max. plate voltage, 750 V.  
Max. d-c plate input, 75 W.  
Grid driving power, 0.22 W.  
\$3.50 Amateur Net

**804**—R-f amplifier pentode.  
Max. plate voltage, 1500 V.  
Max. d-c plate input, 150 W.  
Grid driving power, 2.2 W.  
\$15.00 Amateur Net

**810**—High-mu triode.  
Max. plate voltage, 2250 V.  
Max. d-c plate input, 620 W.  
Grid driving power, 12 W.  
\$13.50 Amateur Net

**806**—Tantalum-plate triode.  
Max. plate voltage, 3300 V.  
Max. d-c plate input, 1000 W.  
Grid driving power, 53 W.  
\$22.00 Amateur Net

**814**—Beam power tetrode.  
Max. plate voltage, 1500 V.  
Max. d-c plate input, 225 W.  
Grid driving power, 1.5 W.  
\$17.50 Amateur Net

**RCA 811 and RCA 812**—For details on these amazing new triodes see the RCA announcement on the back cover of this issue.

**809**  
**INTERMITTENT COMMERCIAL AND AMATEUR SERVICE — RCA-809**  
(Class C Telegraphy)  
High-mu Triode.  
Max. plate voltage, 1000 V.  
Max. d-c plate input, 100 W.  
Grid driving power, 3.8 W.  
\$2.50 Amateur Net.

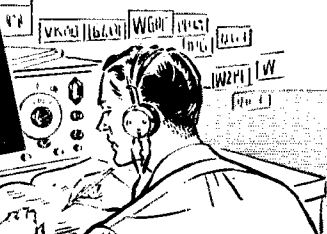

# Radio Tubes

MANUFACTURING CO., INC.,  
CAMDEN, N. J.

Part of The Radio Corporation of America

FIRST IN METAL — FOREMOST IN GLASS — FINEST IN PERFORMANCE

# OHMITE PARTS MEAN *Plus* PERFORMANCE



Write today  
for Free  
Catalog 17

It's to your advantage to get the plus performance and extra value of Ohmite Parts for your rig. They do the job right, even under severest operating conditions. That's why they're so widely used in amateur, commercial and broadcast transmitters and receivers the world over.

**NEW TAP SWITCHES** — For high-current circuit switching. Compact, all-enclosed ceramic construction. 4 sizes from 10 to 75 amperes — 240 V.A.C. ★ **POPULAR "BROWN DEVIL" RESISTORS** — For voltage dropping, bias units, bleeders, etc. ★ **DIVIDOHM ADJUSTABLE RESISTORS** — Easily adjustable to resistance you want — or tapped where needed. Ideal voltage dividers. ★ And, of course, there's the Ohmite Dummy Antenna, Parasitic Suppressor, Band Switch, R.F. Plate and Power Line Chokes, etc.

Available at Your Ohmite Jobber

**OHMITE Manufacturing Co.**  
4855 Flournoy Street, Chicago, U. S. A.

# OHMITE

RHEOSTATS RESISTORS TAP SWITCHES

Kaneohe, Oahu, on a point projecting out into Kaneohe Bay.

It was attended by members of the club, hams, hams to be, and hams that would never be. The field day started late Sunday morning, and by one o'clock all were hungry. K6ICL, the treasurer, brought a truck, with the barbecue steaks, and the rest of the equipment including his mobile transmitter. K6NYD, K8DTT, K6ETF and K6LMP went to work on the ten meter transmitter. Contests started about three o'clock, the first a coconut husking contest. Only feet, hands, and teeth could be used. K6LMP won.

There was Chinese checkers for the ladies, a code contest for 'phone men (K6PWC won), and an antenna stringing contest, a highlight won by K6NYD.

All had a swell time, until "Aloha" and 73.

## "Contender" Uses Amateur Frequency in Gale

**LEAVING** Saturday, September 23rd, forty-three men, whose interest is in radio, chartered the Yacht *Contender* (first in the Honolulu race) for a weekend trip to Catalina Island. Three licensed amateurs were aboard, W6ZAA, Garrett Arnold; W6DEP, Larry Lynde, and W6AM, Don Wallace. There was also Dean Hoffman, to go up for license soon, and ten with previous amateur experience. The transmitter aboard the *Contender*, KLRR, W6XEJ, was intact from the race, and F.C.C. had been notified of portable locations for use of W6AM for the weekend, with September 25th indicated for good measure (a fortunate hunch). On the trip to Catalina the gang had a wonderful time, and successful 10-meter communication. The 350-watt transmitter also worked on the harbor 'phone frequency of 2738 kc., connected with shore on 2176 kc., and was open to public service on 8300 kc., mobile marine c.w.

From our fixed location, amateurs in all districts but two were worked on 10 and 20 meters, including K7PQ (Alaska) on 10. Beams, an Alford array staked to 100 feet above the water line, eleven antennas in all, were available.

Sunday we noticed storm warnings over the weather services just before the scheduled leaving. Captain Dick Loynes, careful skipper that he is, decided to wait for further bulletins. When the gale came from 200 miles at sea there was a battle to save the 75 or more small boats in the harbor. Heavy winds and seas reached tremendous proportions; anchors dragged. When the harbor 'phone and Coast Guard stations could not be heard from it seemed best to look for amateurs to assist us.

We raised W6NCR, 15 miles from L. A., and kept a 160-meter schedule thereafter. His telephone was out of service together with some 35,000 others in southern California. He helped us get W6NZZ (Long Beach) and W6SAL (Compton), who worked Pasadena, so our crew could send messages ashore. Twenty hours of tremendous wind and storm resulted in dozens of missing craft, many dead and unreported, and an estimated million loss due to property damage. Our crowd went from breakfast to breakfast without a meal, and few had any sleep during that 24 hours. The Navy in such times of trouble renders greatest assistance to those who may need it. Our first mate asked us to get hold of the destroyer anchored nearby to see if it was advisable for us to return.

W6NZZ (1950-kc. 'phone) got in touch with San Pedro, and the destroyers were asked to guard 8300 kc. for us. NISX, the U.S.S. *Argonne*, and NATF, the U.S.S. *Wilson*, answered our call. Every time we touched the key plenty of answers were forthcoming, as they zealously guarded our frequency. The channel was reported open for large craft such as the *Contender*, but smaller ships were advised to stay under cover. KLRR sent some paid traffic through KPH, the RCA station in S. F., using all forms of radio possible from the yacht. Many other yachts, nearby, got radio weather information from us, and copies were even posted on the bulletin boards ashore.

— W6AM

## A.E.C. Hams Fight Forest Fire in Black Hills

The sheer indispensability of training in a communications emergency was sharply underscored during July, when, faced by the most devastating forest fire in the history

# NATIONAL DIALS

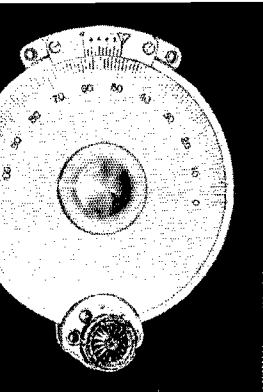

**NW DIAL.** The six-inch NW Dial has an engine divided scale and vernier of solid nickel silver. The vernier is flush with the scale. The variable ratio drive is unusually powerful at all settings. No. 2, 3, 4 or 5 scale.

**Type NW.** List Price, \$15.00

## DIAL SCALES

Scale	Divisions	Rotation	Direction of Condenser Rotation for increase of dial reading
1	0-100-0	180°	Either Counter Clockwise Clockwise Clockwise Clockwise Counter Clockwise
2	0-100	180°	
3	100-0	180°	
4	150-0	270°	
5	200-0	360°	
6	0-150	270°	

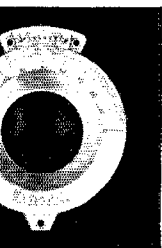

**N DIAL.** The four-inch N dial has an engine divided scale and vernier of solid nickel silver. The vernier is flush with the scale. The planetary drive has a ratio of 5 to 1. No. 2, 3, 4 or 5 scale.

**Type N.** List Price, \$6.75

**A DIAL.** The original "Velvet Vernier" Dial, Type A, still is an unchallenged favorite for general purpose use. It is exceptionally smooth and entirely free from backlash. The mechanism is contained within the bakelite knob and shell. Ratio 5 to 1. No. 2, 4 or 5 scale in 4" diameter. No. 2 scale in 3 3/8" diameter.

**Type A.** List Price, \$3.00

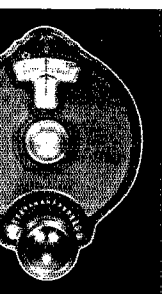
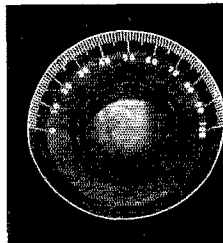

**B Dial.** "Velvet Vernier" Dial, Type B, provides a compact variable-ratio drive that is smooth and trouble free. The mechanism is enclosed in a black bakelite case, the scale being read through a window. No. 1 or 5 scales.

**Type B.** List Price, \$2.75

Illuminator. List Price, \$.50 additional.

**BM DIAL.** The BM Dial is a smaller version of the B Dial (described in the opposite column) for use where space is limited. The drive ratio is fixed. Available with No. 1 or 5 scales.

**Type BM.** List Price, \$2.50

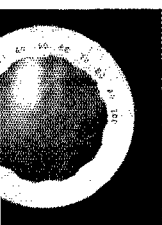
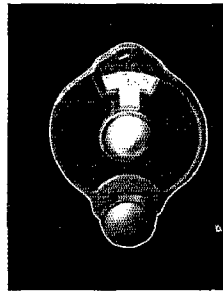

**O DIAL.** The Type O Dial is 3 1/2" in diameter and mounts directly on 1/4" shafts. The scale is solid nickel silver, and is heavily insulated from the hub. A metal brush for grounding the dial is supplied. No. 2 scale.

**Type O Dial.** List Price, \$1.50

**HRO DIAL.** The HRO Dial is 1 5/8" in diameter and fits 1/4" shafts. The etched nickel silver dial is numbered from 0 to 10 over 180°. The dial is not insulated from the shaft on which it mounts.

**Type HRO Dial.** List Price, \$.75

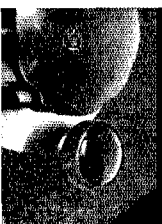
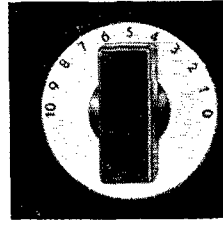

**O DIAL LOCK.** The Type ODL locking device has a thumbscrew control for clamping the Type O Dial. It is ideal for transmitter applications. Not illustrated.

**Type ODL.** List Price, \$.50

**O DIAL DRIVE.** The O Dial Drive device, illustrated at the left, is a useful accessory where fixed tuning is desired.

**Type ODD.** List Price, \$.60

**HRP KNOB.** The HRP Knob is similar to that used on the HRO Dial above. It is 1 1/4" long and 1/2" wide.

**Type HRP.** Less pointer. List Price, \$.25

**Type HRP-P.** With pointer. List Price, \$.35

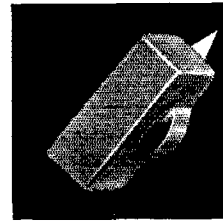

**HRK KNOB.** The HRK Knob is used on the O Dial, the PW condenser and on various receivers. Its comfortable grip and handsome appearance has made it popular on fine instruments. Fits 1/4" shafts.

**Type HRK.** List Price, \$.85

**SHAFT BUSHING.** The use of this bushing is recommended wherever long shafts require an extra bearing. It is particularly suitable for use in panels. Fits 1/4" shafts.

**Type SB.** List Price, \$.25

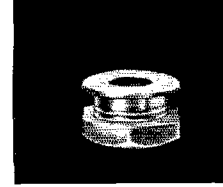

# POCKET SIZE A.C. and D.C. VOLT-OHM-MILLIAMMETER

## MODEL 666-H

Size:  
3 1/16"  
x 5 7/8"  
x 2 1/8"

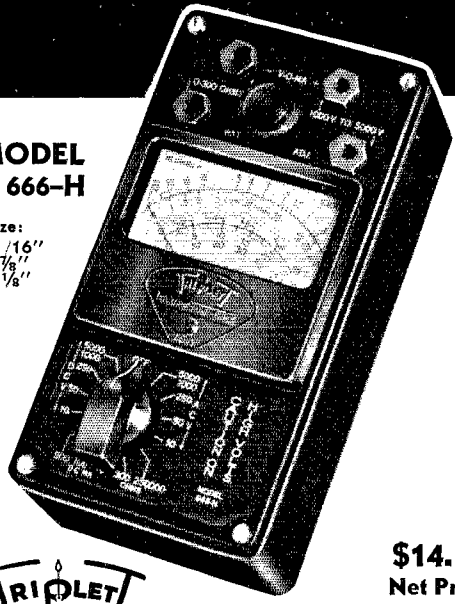

**\$14.50**  
Net Price



## 5000 VOLTS SELF-CONTAINED

● With RED ● DOT Lifetime Guaranteed Measuring Instrument. Ranges: AC-DC Voltage at 1000 ohms per volt 0-10-50-250-1000-5000; DC Milliamperes 0-10-100-500; Resistance 0-300 ohms shunt type, 10 ohm reading at center scale; 0-250,000 ohms, series type, 3700 ohms at center scale. Higher resistance measurements by using external batteries. Complete in Bakelite case. Exclusive Triplet

Low Loss Selector Switch. Handiest and most compact tester built expressly for the Amateur trade. Indispensable for setting up a new circuit or peaking up the old one. Also the "best friend" when something goes wrong.  
Net Price..... \$14.50

Model 666 — same case as above — reads to 1000 volts AC and DC. Net Price.. \$14.00

Triplet Manufactures a Complete Line of Precision Panel Instruments in 21 Styles — 2" to 7" Round, Square, Fan and Twin Cases

## INVESTIGATE THESE AND OTHER OUTSTANDING VALUES

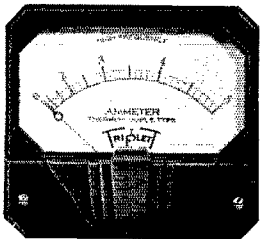

## THERMO AMMETERS

● Model 446 with Front Illumination. Four-inch square modernistic instrument featuring extra long scale. Same case style available for ammeters, milliammeters, microammeters, voltmeters, millivoltmeters, etc., AC and DC.

WRITE FOR CATALOG

SECTION 2511 HARMON AVE.

THE TRIPLET ELECTRICAL INSTRUMENT CO.  
Bluffton, Ohio

of the South Dakota Black Hills, forestry service officials turned for the first time to A.R.R.L. Emergency Corps hams for auxiliary radio operators in the fire area — and were "entirely satisfied with results."

The fire, well away from the Mt. Rushmore memorial, broke out late on the afternoon of July 10th. Fanned by a 50-mile wind the blaze quickly developed into a "crown" fire, the type most dreaded by foresters, racing from treetop to treetop, and overnight threatening several mining towns in the area.

As soon as the seriousness of the blaze was apparent, Emergency Coördinator Wallace Koppmann, W9YOB, telephoned Forestry Service Headquarters and offered the services of the Rapid City A.R.R.L. Emergency Corps. Within a matter of minutes Peyton Nelson, W9YJX, and Glen Coates, W9APT, were on their way to the fire lines, to be joined later by Jesse White, W9KNV, Richard Prohs, W9CVR, and Victor Fite, W9SWV.

The forestry service furnished the rigs. Fortified by monthly emergency drills (every licensed member of the Rapid City club is a member of the A.E.C.) the boys were equal to every demand. In previous fires intrained operators had been sent to the lines with simple 'phone rigs and brief instructions, and results had been haphazard and unsatisfactory.

Efficient communications were a major factor in the low loss of life during the fire. There were only two casualties; one C.C.C. enrollee was killed by lightning while on fire duty, and a salesman was killed in an auto crash attributed to traffic congestion in the fire area. Fifty children were safely evacuated from Camp Wanzer, state tuberculosis camp, and citizens of Hill City and Mystic were warned to be ready to leave those towns on short notice. With the shifting wind, the direction of fire progress was uncertain from hour to hour, and without efficient communication the danger of a shift trapping a section of the fighters would have been grave. Telephone communication in the area was completely paralyzed. Approximately 1100 messages were handled during the fire and the "mopping-up" period afterward.

The boys operated on 3155-kc., using as calls the serial numbers of the rigs they were using. W9YJX operated SPF 404 from July 11th through July 17th, W9APT SP 234, SPF 402 and SP 232 from the 11th through the 18th, W9KNV SPF 402 from the 14th through the 17th, and W9CVR SP 402 through the 18th. W9SWV acted as relief operator for Ralph Muncy, chief forester operator, during the entire period. Most of the work was done on 'phone.

Both the SP and SPF outfits are run from dry cells, with an input of about four watts. The SPF rig (described in QST for April, 1938) utilizes a type 19 tube as crystal oscillator-buffer, driving a parallel-connected 19 in the final, modulated by a Class B 19 driven by a 1F4. The receiver is a four-tube super using a 1A6 as frequency converter, two 1A4's as i.f.'s, and a 1B5 as diode detector, a.v.c., and audio amplifier. Depending upon the battery used the rig weighs 22 or 36 pounds.

The SP is an older rig, using a 49 as crystal oscillator driving parallel-connected 49's in the final. The speech channel uses the same tube types — a 49 as speech amplifier, driving 49's in push-pull as Class A modulator. The receiver is a type 30 regenerative detector transformer-coupled to a type 30 audio amplifier.

While the fire was at its height the stations operated at hot spots in the lines, handling all traffic concerning the fire, orders for the movement of men and civilians, orders for the movement of equipment, and reports from field foremen and superintendents to their superiors. After the fire was brought under control, the stations were moved to mountain peaks where large areas could be surveyed, and from which points new "smokes" or points where the fire threatened to get out of control could be reported to headquarters.

And so, a new rôle for the A.R.R.L. Emergency Corps, and proof that times of peace bring sudden demands for trained operators just as do times of war. Had it not been for the personnel — and emergency training — of the Rapid City Emergency Corps, the Mt. Rushmore area and the rest of South Dakota's vacationland might conceivably be a smoldering, blackened ruin. "It can't happen here?" That's what the boys in Rapid City thought, too — but when it did happen, they were ready. 'Nuff sed!

— A. L. Russell, W9YOD, S.C.M. South Dakota.

# RESULTS OF THE 1939 INTERNATIONAL DX CONTESTS ESTABLISH THESE SIX IMPORTANT FACTS

**47%**  
 1. of all the DX phone (VE & W) winning contestants use Eimac tubes.

2. Two of the three highest scores in the CW Contest and all three highest scores in the Phone Contest use Eimac tubes. As listed in Oct. QST.

**42%**  
 3. of all the DX c. w. (VE & W) winning contestants use Eimac tubes.

4. Tubes with tantalum plates are far superior when it comes to actual performance. First, second and third winners and four out of seven of the entire list of winners used tubes with tantalum plates.

5. Eimac tubes are first choice by the majority of the leading amateurs. Five of the first six winners and five out of every eleven of the winning (VE & W) list use Eimac tubes.

6. Six out of every ten of the (W) sectional winners, as listed in October QST, used tantalum plate tubes and Eimac tubes lead the field in this group five to one.

The fact that 44% of all the winning amateurs in the phone and CW contests use Eimac Tubes should indicate to you that . . . where performance and dependability are a factor . . . Eimac Tubes are first choice. (See lists in your October QST.)



Eitel-McCullough, Inc.  
 San Bruno, California

# JUST OUT . . . SYLVANIA'S BIGGER AND BETTER

## TECHNICAL MANUAL

( 1940  
EDITION )

Send for your  
copy of this big  
"tube fact" book  
today



● The 1940 Sylvania Technical Manual is bigger and better than ever with a new easy-to-use arrangement. It has 264 pages packed with vital tube information for servicemen, radio technicians, engineers and amateurs.

It gives you complete data and tube diagrams for 344 types of tubes all now listed in numerical-alphabetical order for quicker reference. Operating conditions, characteristics and circuit applications for standard glass tubes, "G" types, "GT" types, Loktal, Metal, Majestic and special types. Full information, too, on Sylvania's complete line of panel lamps.

The new Manual also includes data on special tubes for particular applications in television amplifiers, cathode-ray tubes, etc., with new circuit information and diagrams covering the latest type tubes.

Send the coupon below for your copy! This new edition is a bargain at only 35c.

# SYLVANIA

Set-Tested Radio Tubes

HYGRADE SYLVANIA CORP. Q 119  
Emporium, Pa.

Here is 35c. Please send me a copy of the bigger and better Sylvania Technical Manual.

Name.....

Address.....

City..... State.....

Serviceman  Experimenter  Dealer  Amateur

## W-VE Contest Scores

(Continued from page 41)

	Message Score	Preambles Sent	Contacts Received	Confirmed	Sectors Worked
DAE	1800	20	20	16	5
ROX	700	14	12	11	2
QKQ	594	11	11	9	3
BMX	270	5	5	2	3
<i>Wisconsin</i>					
W9VDY	19467	103	103	63	7
EYH	18144	96	96	58	7
RBI	13135	70	69	41	7
RQM	9450	50	50	34	7
MBX	7812	62	62	38	7
YMG	3780	30	30	20	7
KXK	1530	17	17	14	5
<b>DAKOTA DIVISION:</b>					
<i>North Dakota</i>					
W9VJH	3726	23	23	15	6
<i>South Dakota</i>					
W9MRS	3847	29	29	21	5
YOB	3321	21	21	12	6
WUU	810	10	10	8	3
<i>Northern Minnesota</i>					
W9YCR	15876	84	84	54	7
DNY	1890	14	14	6	5
WUQ	729	9	9	7	3
<i>Southern Minnesota</i>					
W9YXO	12946	71	67	45	7
VIP	5184	32	32	20	6
TYE	1440	20	20	12	4
KUI	769	9	9	7	3
<b>DELTA DIVISION:</b>					
<i>Louisiana</i>					
W5KC	9639	51	51	39	7
EUK/5	2592	16	16	11	6
HGT	2565	19	19	12	5
<i>Mississippi</i>					
W5FIT	2916	18	18	14	6
<i>Tennessee</i>					
W4FDT	1620	12	12	10	5
<b>HUDSON DIVISION:</b>					
<i>Eastern New York</i>					
W2JRG	11056	59	58	35	7
EWO	6723	42	41	20	6
<i>New York City and Long Island</i>					
W2IOP	30429	161	161	92	7
EGG	18711	99	99	60	7
IRV	14553	77	77	52	7
KKU	13419	71	71	50	7
HUG	11529	63	59	50	7
KYV	6966	44	42	27	6
CKQ	3717	30	29	23	7
AOD	2700	25	25	19	6
AQQ	918	17	17	13	2
LQP	854	11	10	7	3
LPZ	216	4	4	3	2
KWB	27	1	1	0	1
<i>Northern New Jersey</i>					
W2JKH	24003	127	127	71	7
WC	16159	86	85	58	7
GSA	13041	69	69	60	7
IGT	7749	42	40	16	7
LMM	7560	40	40	26	7
DBY	7308	58	58	34	7
HZN	4788	38	38	17	7
LXI	3996	37	37	27	6
LUE	3560	22	22	15	6
JJE	2673	34	33	20	3
CW	2349	29	29	17	3
CAY	2187	14	13	8	6
DZA	1836	17	17	10	6
JSX	1512	14	14	9	4
LPJ	1080	10	10	4	4
KBQ	540	10	10	5	2
JRU	270	5	5	4	3
HRN	216	4	4	3	2
<b>MIDWEST DIVISION:</b>					
<i>Iowa</i>					
W9CFB	11340	60	60	35	7
LDH	9072	48	48	29	7
YQY	4536	28	28	21	6



# Designed for Application

**T**HE experienced amateur will see quickly enough what we mean by our slogan, "Designed for Application" when he studies the many new and different parts illustrated and listed in our new catalog. If you don't have a copy yet, be sure and get one from your dealer while his supply lasts. In it you will find new types of sockets that can't flash over between contacts, that are easy to mount, and that have contacts that will really stand up in hard service! You will also find new types of dials, midget condensers, radically different designs of transmitting condensers, safety terminals, A.C. terminal blocks, Isolantite rectifier tube plate caps, Isolantite bushings, flexible couplings, transmission line spreaders, and a host of other novel, better performing and easier to use component parts.



This remarkable material has made possible, in our No. 15001 neutralizing condenser, a design that is within reason relative to the size of the tube with which it is to be used as well as much less expensive to manufacture and sell.

For instance, the little No. 15001 condenser is ideal for use with such low capacity tubes as the 35T, the HK24, the HK54, the 807, the T55, the T40, the T20, the HY40 and the HY25. For the higher-capacity tubes the No. 15002 takes care of about everything. It actually has a low enough minimum (0.5  $\mu\text{mf}$ ) to neutralize 6L6s and a maximum of 13.5  $\mu\text{mf}$  which is a ratio of 27 to 1!!!! Incidentally, though conservatively rated at 6000 v. breakdown, the No. 15002 in a recent test in one of the large Eastern technical college laboratories, took 30,000 volts A.C. to cause a flashover to ground! Even then the polystyrene insulation was not punctured!!!

Only three round holes are needed to subpanel mount this new style crystal holder socket! The two round bosses protruding thru the panel not only result in an exceedingly neat appearing arrangement, but also raise the bottom of the holder from the chassis or panel by just the right amount. Incidentally, when Bill Eitel of Eimac dropped in to see us the

Remember Herb Riddle's story in the August issue of *QST*? Well, the polystyrene parts he had reference to as "soon to make their appearance," are our QuartzQ (genuine Monsanto Polystyrene) sheets, standoffs, neutralizing condensers and acorn tube sockets.

other day and had a chance to examine the socket, he suggested a new and different application . . . as an inexpensive double bushing for the link lines between R.F. stages in a transmitter. In our own lab we are using them as input and output terminals for all sorts of different pieces of lab gear. And now as we write this page it seems that still another possible application would be for small rigid ultra-high-frequency coil sockets for both receivers and transmitters!



Some amateurs may wonder "why" QuartzQ standoffs. Anyone who has tried other materials for this purpose in supporting the linear tank circuit bars of a stabilized ultra-high-frequency oscillator knows the answer! They just DO NOT EXPLODE!

In fact they won't even get warm! After all, the power factor of QuartzQ is practically zero (0.02%). QuartzQ sheets are only available in one size at present . . . 3" x 8 1/2" x 1/10" . . . The price is only 35¢!

The acorn QuartzQ socket is, like most of our other products, the only thing of its kind. In addition to the use of QuartzQ for the extrusion-molded base, the base has in itself been designed with a view to using the very minimum of material. . . . Yes, it's hollow!

If you couldn't make the detector oscillate in that 1 1/4-meter superegen receiver you built last winter with conventional sockets, just try one of these new QuartzQ ones. You will be surprised at how easily it cleans up the trouble.

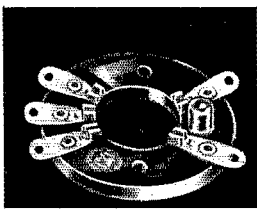
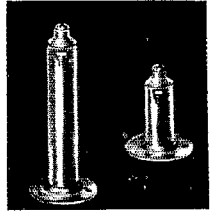

Aside from the QuartzQ neutralizing condensers and the centre mounted transmitting condensers, the most spectacular item in our line as yet, is the HETROFIL. Ray Woodward's article in the September issue, plus the illustration at the right, tells the story. Since writing the *QST* article, Dr. Woodward has done considerably more laboratory work which is incorporated in the commercial model of the HETROFIL. One of the changes pertains to the use of different values for the fixed resistors and condensers so as to eliminate the necessity for the dual range and the consequent complication of switching. Yes, the advertisements last month were correct — the price is only \$3.50!!

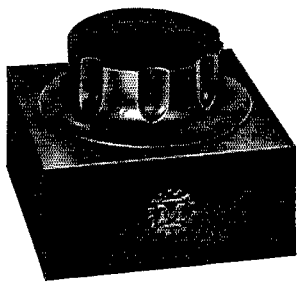

**JAMES MILLEN**  
150 EXCHANGE ST



**MFG. CO. Inc.**  
MALDEN, MASS.

"Just any old Plug"

WON'T  
DO

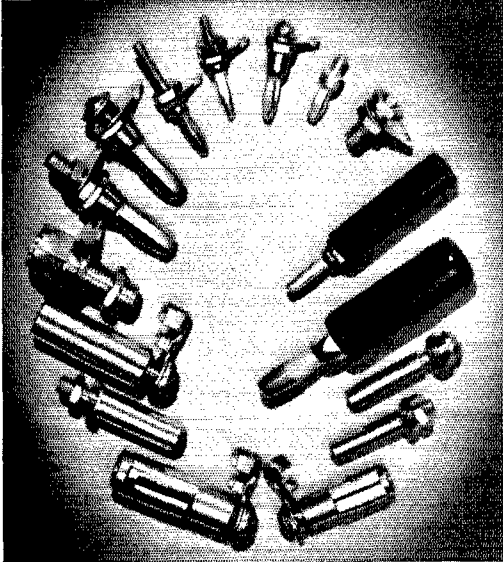
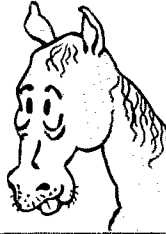

DEPEND ON  
**JOHNSON**  
PLUGS and JACKS

Many times an otherwise f.b. rig will fail to function as it should because of neglect at some minor detail. You can depend on JOHNSON plugs and jacks. Proved by years of acceptance, they always do the job. They love contacts, slide together smoothly, hold tenaciously, release readily.

JOHNSON "Banana Spring" plugs are made in wide variety, from the smallest, No. 75D (with beryllium copper spring, specified for exacting Government requirements), to the heavy duty 77 series. Note the new insulating handles, of generous size, in polished black or red plastic. JOHNSON "Spring Sleeve" types (lower views) are exceptionally rugged, stand heavy currents. Learn more about these and other dependable JOHNSON products.

Ask your Jobber or write for  
new 2 color Catalog 966J



**E. F. JOHNSON CO.**  
WASECA, MINNESOTA  
EXPORT: 25 WARREN ST., NEW YORK, N. Y.  
"MANUFACTURERS OF RADIO TRANSMITTING EQUIPMENT"

	Score	Message Sent	Preambles Received	Contacts Confirmed	Sections Worked
<b>Kansas</b>					
W9YRS	13135	71	68	45	7
WCB	12852	68	68	44	7
QXG	11907	63	63	48	7
CWW	7182	38	38	28	7
AWP	4788	38	38	29	7
QQP	2520	20	20	10	7
YAH	2227	17	16	11	5
BYV	432	8	8	6	2
<b>Missouri</b>					
W9RSO	8568	68	68	47	7
PGI	8100	50	50	33	6
WCM	5103	41	40	34	7
IND	4725	25	25	19	7
JKI	1350	13	12	10	4
<b>Nebraska</b>					
W9ZRP	14175	75	75	50	7
TQD	9450	50	50	38	7
RQS	2700	25	25	17	6
BIW	1215	14	13	8	5
MZF	864	8	8	7	5
<b>NEW ENGLAND DIVISION:</b>					
<b>Connecticut</b>					
W1TS	23058	122	122	44	7
APA	2268	28	28	15	3
IIS	1215	15	15	5	3
BIH	990	11	11	5	5
ACV	324	9	9	5	2
<b>Maine</b>					
W1IRB	6804	36	36	17	7
CKJ	1134	14	14	6	3
YA	621	13	10	5	3
LMQ	405	5	5	1	3
<b>Eastern Massachusetts</b>					
W1RY	13932	86	86	36	6
BDU	3847	29	29	10	5
KCQ	756	14	14	8	3
DCH	445	6	5	5	3
EMG	108	2	2	1	2
QW	72	2	2	1	2
<b>Western Massachusetts</b>					
W1KIK	1701	21	21	8	3
KOS	594	11	11	3	2
LDI	526	13	0	3	3
<b>New Hampshire</b>					
W1KIN	1539	19	19	11	3
<b>Rhode Island</b>					
W1KOG	5724	53	53	29	4
JXQ	810	10	10	3	3
LAB	468	13	13	6	2
<b>Vermont</b>					
W1EZ	21546	114	114	44	7
FRT	2025	25	25	13	3
KOO	972	12	12	6	3
<b>NORTHWESTERN DIVISION:</b>					
<b>Montana</b>					
W7EC	7308	58	58	38	7
EWR	3060	35	33	27	5
HEM	2700	21	19	12	5
CKG	27	1	1	1	1
<b>Oregon</b>					
W7GPP	12285	66	64	32	7
GHB	6480	40	40	23	6
MF/6	4532	36	36	19	7
GUR	252	7	7	3	2
<b>Washington</b>					
W7CMB	15592	82	82	45	7
FLV	15214	81	80	41	7
GLH	4914	26	26	18	7
GZB	2052	24	24	7	4
<b>PACIFIC DIVISION:</b>					
<b>Hawaii</b>					
K6CGK	486	9	9	1	3
<b>Santa Clara Valley</b>					
W6OFQ	8343	52	51	32	6
<b>East Bay</b>					
W6ITH	10206	54	54	20	7
OCH	10080	80	80	11	7
LNZ	3276	26	26	18	7

# WHAT

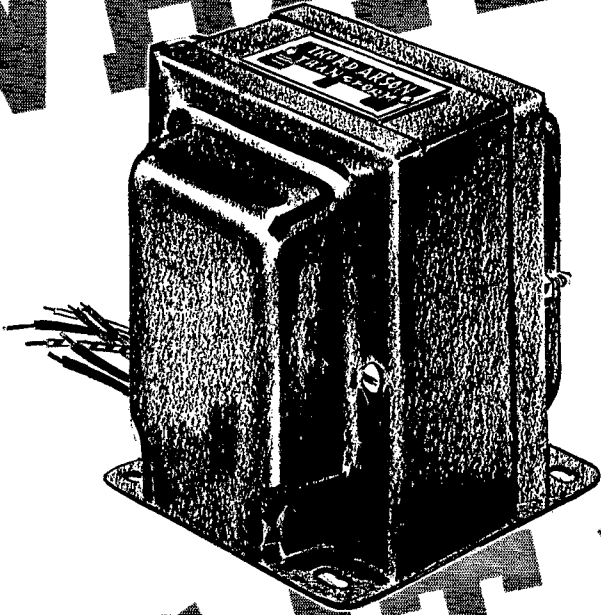

# IS IT?

**I**T is the largest-selling Plate Supply Transformer in the world—the THORDARSON T-19P56! Ten pounds of the most scientifically engineered iron and copper—built with the ruggedness of Gibraltar, to give amateurs dependable service for years. Your favorite Parts Jobber has just the THORDARSON transformer you need for *any* purpose—transmitter or receiver. Ask your Parts Jobber for Catalog 400-D.

# THORDARSON

Elec. Mfg. Co., Chicago

**“THERE IS 44 YEARS OF EXPERIENCE BUILT INTO EVERY THORDARSON TRANSFORMER”**

# Not satisfied with "GOOD ENOUGH" . . .

There's a healthy mixture of "experimenter blood" in our organization, and a large portion of the time in our lab is devoted to "monkeying around" with new ideas. This notwithstanding the fact that our test equipment units are now recognized as "TOP QUALITY" . . . every instrument being checked and calibrated against laboratory standards.

Our units provide complete facilities for obtaining all measurement requirements for Amateur, Service, Laboratory, Television and Industrial uses. You are sure to find one to satisfy you . . . at a price that makes it "tops" in value.

## New Precision Series 844 — 34 Range



**AC-DC VOLT-  
OHM-DECIBEL-  
MILLIAMMETER**

including ranges of

**6,000  
Volts AC-DC  
10 Megohms  
and  
12 Amperes**

Large 4 1/2" D'Arsonval square type meter. Wire wound shunts and matched multipliers of 1% accuracy.

★ SIX A.C. and D.C. VOLTAGE RANGES at 1000 ohms per volt: 0 to 12/60/300/600/1200 and 6000 volts.

★ SIX D.C. CURRENT RANGES: 0/1/2/12/60/300/1200 MA; and 0-12 Amperes.

★ SIX DECIBEL RANGES from -12 to +70DB.

★ FOUR RESISTANCE RANGES: 0-400; 0-100,000; 0-1 Meg.; and 0-10 Megs.

★ Provisions for Mounting Ohmmeter Batteries (4 1/2 and 45 volts) on inside of case.

★ SIX OUTPUT RANGES: 0 to 12/60/300/600/1200 and 6000 volts.

844-L — Walnut finished hardwood case with carrying handle. (7 x 8 x 4). Less batteries and test leads. Net . . . **\$22.95**

844-P — Closed type, removable cover, tool compartment. Net . . . **\$24.95**

### SERIES 830

**DC VOLT-OHM-  
MILLIAMMETER**

Large 3-inch modern D'Arsonval type meter of 2% accuracy; wire wound shunts and matched metallized multipliers of 1% accuracy. Small in size (7 x 8 x 4) yet incorporating the well known PRECISION standard of accuracy.

**\$10.95**

★ FIVE D.C. voltage ranges at 1000 ohms per volt: 0-10; 0-100; 0-250; 0-500; 0-1000 volts.

★ FOUR D.C. current ranges: 0-1; 0-10; 0-100; 0-250 MA.

★ Two resistance ranges: Low Ohms (shunt method 1/4 to 500 Ohms). High ohms 0-300,000 Ohms. Ohmmeter ranges are powered by self-contained supply.

See these two as well as other popular PRECISION Test Equipment models on display at all leading radio parts distributors. Fifteen types and combinations of Multi-Range testers and Set Analyzers . . . 16 types and combinations of Mutual Conductance Tube Testers and Set Testers . . . Signal Generators, too . . . Ask for your 1940 catalog.



STANDARD OF ACCURACY

PRECISION

TEST EQUIPMENT

SEE THEM AT YOUR JOBBER

**PRECISION APPARATUS COMPANY**

**647 Kent Avenue Brooklyn, New York**

Export Division: 458 Broadway, New York City, U. S. A.

Cable Address: *Morhanex*

Score Message Sent Preambles Received Contacts Confirmed Sections Worked

	Score	Message Sent	Preambles Received	Contacts Confirmed	Sections Worked
<b>San Francisco</b>					
W6PGB	4284	34	34	25	7
<b>Sacramento Valley</b>					
W6PAR	7560	40	40	25	7
OMR	2565	19	19	14	5
GVM	980	10	10	6	5
HYF	360	5	5	5	4
DHS	288	8	8	6	2
<b>San Joaquin Valley</b>					
W6BIL	3969	25	24	17	6
CLZ	2700	25	25	21	6
DIX	810	10	10	0	3
<b>ROANOKE DIVISION:</b>					
<b>North Carolina</b>					
W4BIT	6210	58	57	33	6
CDG	3654	29	29	10	7
<b>South Carolina</b>					
W4BQE	4284	34	34	10	7
<b>Virginia</b>					
W3FBL	1620	15	15	9	4
ELN	1188	22	22	12	3
HWJ	144	4	4	4	2
CYV	72	2	2	2	2
<b>West Virginia</b>					
W8JIM	1417	18	17	12	3
<b>ROCKY MOUNTAIN DIVISION:</b>					
<b>Colorado</b>					
W9YAD	18238	97	96	60	7
<b>Utah-Wyoming</b>					
W6PQT	6048	56	56	5	6
W6WV	1890	14	14	10	5
W7GCO	1836	17	17	12	6
W6QVY	567	7	7	5	3
W6PGH	405	5	5	4	3
W7HDS	72	2	2	2	2
<b>SOUTHEASTERN DIVISION:</b>					
<b>Alabama</b>					
W4AII	10206	54	54	36	7
EHH	2620	20	20	9	7
<b>Western Florida</b>					
W4EPT	1485	11	11	8	5
<b>Georgia</b>					
W4FIJ	7182	57	57	39	7
DXI	2898	24	21	7	7
FDJ	972	9	9	4	6
<b>SOUTHWESTERN DIVISION:</b>					
<b>Los Angeles</b>					
W6MXN	1530	17	17	13	5
NNV	1030	8	8	5	5
<b>Arizona</b>					
W6QAP	14836	89	86	55	7
LAI	7749	41	41	31	7
<b>San Diego</b>					
W6BBR	6804	54	54	27	7
ISG	5607	45	44	22	7
NIK	4050	26	24	20	6
OLU	3105	23	23	16	5
<b>WEST GULF DIVISION:</b>					
<b>New Mexico</b>					
W5HAG	5092	28	28	19	7
GGX	1782	11	11	6	6
GSD	810	6	6	4	5
<b>Northern Texas</b>					
W5DQP	11151	59	59	47	7
GGG	243	3	3	3	3
<b>Oklahoma</b>					
W5AQE	9450	50	50	31	7
CJZ	6615	53	52	34	7
EHP	3402	27	27	23	7
HGD	2268	23	19	18	5
GVP	540	5	5	5	4
<b>Southern Texas</b>					
W5GSE	6174	49	49	36	7
DWO	6048	32	32	19	7
GWL	540	5	5	3	6

# CARDWELL CONDENSERS

*Are always "well represented"*

HALLICRAFTERS

B & W

WESTERN ELECTRIC

COLLINS

COLLINS

CARDWELL condensers never fail to justify their choice for finest commercial equipment, reflecting the prestige of the product of which they become a part.

HARVEY 100-T  
TRANSMITTER

RADIO  
ENGINEERING  
LABS.

**THE ALLEN D. CARDWELL  
MANUFACTURING CORPORATION**  
85 PROSPECT STREET, BROOKLYN, NEW YORK

# These Crystals FLUNKED their FINALS!

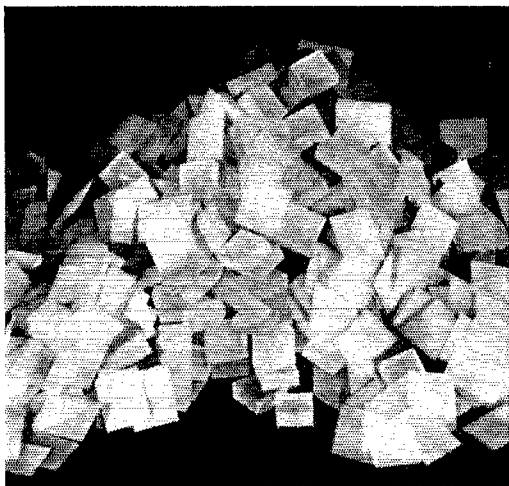

Somewhere along the line—in perhaps just one particular test, these crystals failed to meet the Monitor quality requirements. They received four tests on activity, four on drift, and four on frequency. They were checked for dimensional activity (which influences output) and against twin peaks. In addition to all these, most Monitor crystals receive ten special examinations for determining characteristics known only to Monitor engineers. Each crystal must pass every single one of these tests before Monitor accepts it.

Most of the crystals above would probably operate satisfactorily in your rig, but, to assure you the finest possible performance, every Monitor crystal must pass above a certain set standard in each of the many tests subjected to it. That's why every Monitor crystal is of the highest possible quality.

By detailed examination of their product, Monitor engineers have won an unmatched position for crystal dependability. That's why commercial interests the world over have specified Monitor crystals for nearly ten years for aviation, marine, and police work. With any of the complete line of Monitor crystals, you are guaranteed better performance, trouble-free operation, and quality higher than the price!

Available at your dealer's or write direct to us.

# MONITOR

Piezo  Products Co.

1138 MISSION ST., SOUTH PASADENA, CALIF.

## New Transmitting Tube Ratings

(Continued from page 48)

large increase in useful power output. For example, the a.f. power output of two 809's in Class B is 100 watts at the old maximum plate-voltage rating of 750 volts. At the new ICAS rating of 1000 volts, the power output is 145 watts — an increase of 45 per cent. In plate-modulated telephony service, the r.f. output of the 809 is 38 watts with the CCS ratings and 55 watts with the new ICAS ratings — also an increase of about 45 per cent. Complete operating data, including both CCS and ICAS ratings, have been prepared for RCA types 802, 804, 806, 807, 809, 810, and 814, as well as for the new 811, 812, and 828, and can be obtained on request.

"The new system provides transmitting-tube ratings which recognize the diversified design requirements of modern transmitter applications. For example, there are numerous applications where the design factors of minimum size, light weight, low initial cost, and maximum power output are far more important than extremely long tube life. In such cases, the set designer may very properly decide that a small tube operated with ICAS ratings better meets his requirements than a larger tube operated with CCS ratings.

"It is self-evident, of course, that the harder a tube is worked the shorter will be its useful life. Although no rule can be set up which will accurately predict the life performance of an individual tube under specified operating conditions, it is practical to make an estimate of tube life on the basis of average results from a large number of tubes. In average amateur service, a tube operated at the higher ratings can normally be expected to give about 50 per cent of the life obtainable with CCS ratings.

"It has been estimated that an active amateur does not have his carrier on the air more than 300 hours per year. Therefore, a tube lasting 1000 to 1500 hours when used with CCS ratings would give him at least 3½ to 5 years of service. The amateur, because he is usually most interested in low initial cost and maximum power output, may consequently decide that the ICAS ratings are better suited for his purpose.

"The engineer designing a broadcast transmitter has quite a different problem. A broadcast station may operate tubes on an average of 18 hours a day. Tube failures are expensive both in themselves and in advertising revenue lost because of interrupted programs. Consequently, since reliability is his main concern, he should operate tubes at the CCS ratings, or perhaps even lower. Only in this way can he obtain the long tube life required for continuous commercial services.

"In view of the fact that the ICAS ratings are considerably higher than the former maximum ratings, an explanation of the basis on which these new ratings are established is desirable. The old method of rating transmitting tubes has been based on the assumption that tubes would always be used under the most severe operating conditions possible for each class of service. Although

# STANCOR Hamanual

FOURTH EDITION

THE FOURTH EDITION HAMANUAL THOROUGHLY DESCRIBES A HOST OF NEW TRANSMITTERS AND AMPLIFIERS...

This new Stancor Hamanual available NOW at your Jobbers — get your copy. Your dealer's name furnished upon request — write us.

## INCLUDING THESE TWO:

### STANCOR 12-E EMERGENCY TRANSMITTER

The logical answer to the emergency problem. Low drain operation from a 6 volt DC source. Crystal control on 1.7, 3.5, and 7 MC bands. 12 watts input to R.F. Amplifier. Universal antenna coupler — self-contained. Easy band shift — phone or CW.

*Approximate net price, less coil, tubes, crystal, dust cover and Vibropack.....*

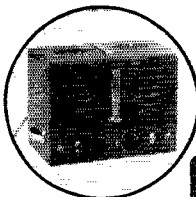

**\$14<sup>50</sup>**

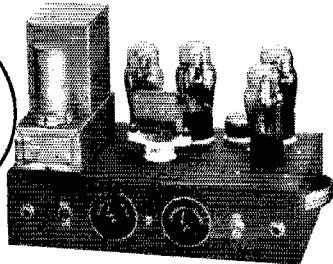

### STANCOR 10-P TRANSMITTER

Unparalleled versatility in a low power rig. Five band operation (10-160 meters) with but three crystals. R.F. Amplifier Input — 12 watts phone, 20 watts CW. Four tubes — only one tuned circuit. High level modulation — break-in for CW. Price includes cabinet, escutcheon, etc.

*Approximate net price, less tubes, coil, crystal and meter.....*

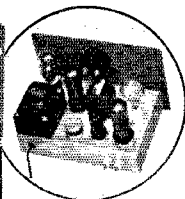
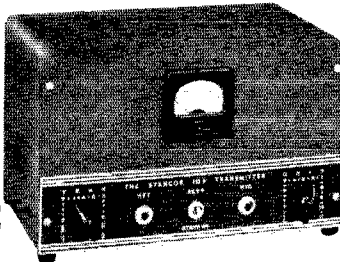

**\$21<sup>00</sup>**

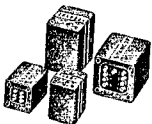

### STANCOR HI-FI TRANSFORMERS

A most exacting transformer in performance and appearance. High Fidelity that really means ultimate in tone quality. A precision product from start to finish. See it at your dealers.



# STANDARD TRANSFORMER CORPORATION

1500 NORTH HALSTED STREET  
CHICAGO

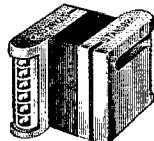

### STANCOR THOROBRED

America's first safety plate transformer. The only transformer of its kind — anywhere. Your Stancor Jobber has it — be sure to see it.

# You get this FINER MOVEMENT

only in  
**SIMPSON  
Instruments**

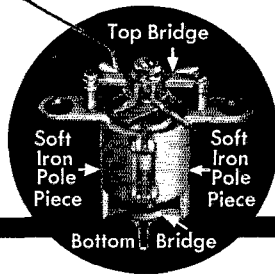
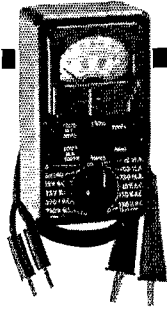

**T**HAT this expensive bridge type construction with soft iron pole pieces could be used in instruments priced no higher than the ordinary kind, has been the marvel of those who know instrument construction.

This finer movement is the heart of the "Hammeter"—the first self-contained pocket-size tester built expressly for your needs. Notice the ranges of this tester listed opposite. Both A.C. and D.C. ranges have resistance of 1,000 ohms per volt. It is shock-proof throughout—test cables are insulated for 5,000 volts; tips and clips are also heavily insulated. Measuring only  $5\frac{1}{4} \times 2\frac{1}{8} \times 1\frac{1}{4}$  inches, and weighing only 20 ounces, the Hammeter is the answer to every trouble-shooting and checking need. When you see it, you will be all the more astonished at its low price.

**MODEL 240  
HAMMETER**  
3,000 volts self-contained (no external multipliers necessary).  
A.C. volts: 0-15-150 - 750 - 3000;  
D.C. volts: 0-15-75-300-750-3000;  
D.C. milliamps: 0 - 15 - 150 - 750;  
ohms: 0 - 3000 (center scale 30) and 0 - 300,000 (center scale 3,000).  
Your net price **\$14.75**

## PANEL INSTRUMENTS WITH THE SIMPSON MOVEMENT COST NO MORE

You pay no more for panel instruments having the Simpson Bridge Type Movement with soft iron pole pieces. Here are typical values:

**R.F. AMMETERS**—Internal, thermo-couple radio frequency ammeters (1, 1½, 2, 2½, 3 or 5 Amps).  
Your net price..... **\$4.67**

**HIGH RANGE VOLTMETERS**—D.C. plate voltmeters, complete with external resistors, (1,000 - 1,500 - 2,000 - 2,500 - 3,000 or 4,000 volts).  
Your net price..... **\$9.07**  
(5,000 volt range \$12.00 net)

**DECIBEL METERS**—Rectifier type volume level indicator | -10 to 6 db (500 ohm line; 6 At. W. T.).  
Your net price..... **\$8.00**

**OTHER OUTSTANDING VALUES ARE:**  
D.C. plate milliammeters (all popular ranges from 0-5 to 0-1,000 milliamps).  
List \$6.35. Your net price..... **\$4.23**

A.C. filament voltmeters (0-10 or 0-15 V.).  
List price \$6.35.  
Your net price..... **\$4.23**

Illuminated dials for all popular ranges, including 6 V. lamp, 50c net additional.

**SIMPSON ELECTRIC CO.**  
5210 Kinzie St., Chicago, Ill.

**SIMPSON**  
INSTRUMENTS THAT STAY ACCURATE



it was recognized that this method was not representative of actual operating conditions, it did provide a very large factor of safety. In recent years, rapid progress in tube design, tube manufacture, transmitter design, and operating technique has made it practical to refine the method of rating transmitting tubes so that it more closely represents actual operating requirements.

"For example, in Class-C telegraph service, the old ratings were set up on the basis of continuous, key-down operation. In practice, however, all Class-C stages which are keyed are not under load when the key is up, as it is during spacing intervals. The average load on the tube is, of course, much less than it is under steady, key-down conditions.

"In Class-C plate-modulated telephony service, the old ratings were based on steady, 100 per cent, sine-wave modulation. Under this condition, the total plate input (d.c. and a.c.) is 1.5 times the unmodulated d.c. plate input. In practice, a broadcast transmitter (for example) modulates its carrier on the average only 25 to 30 per cent. Under these conditions, the average plate power input is only 5 per cent higher than the unmodulated d.c. plate input.

"Similarly, the old Class-B a.f. amplifier ratings were based on steady, full-signal operating conditions with a sine-wave signal. Actually, the average signal is much smaller than the maximum value and the average d.c. plate current and power input varies continuously between no-signal and full-signal values. In addition, it is well known that speech signals place a much lighter load on the Class-B amplifier than signals having sinusoidal waveform.

"In Class-B r.f. amplifier service, the old ratings were based on carrier conditions where the carrier output represents  $\frac{1}{3}$  of the d.c. plate input and the other two thirds is dissipated by the plate. At 100 per cent modulation, however, the efficiency of the amplifier increases to approximately 50 per cent, so that the plate dissipation is reduced about 25 per cent. However, because the average decrease in plate dissipation is rather small, the ICAS ratings for this class of service have to be more conservative than for the other services.

"It is apparent from the foregoing considerations that increased transmitting-tube ratings are practical for many applications. The new ICAS ratings, together with the CCS ratings, make it possible for the radio amateur and the radio engineer to choose the operating conditions best suited for the job at hand."

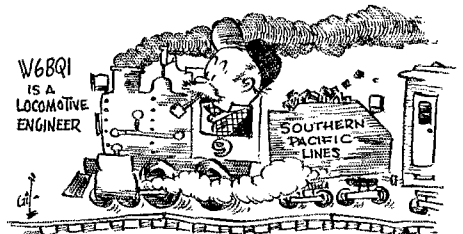



*they may look alike*



*but*

. . . put to the test, all capacitors are *not* alike. They differ in life span, in number of advanced features, in dependability. Unfortunately the eye cannot see these important differences. There is a way, however, that you can be sure you're getting the all-around tops in capacitor value. Look for the name CORNELL-DUBILIER on the label. Only capacitors bearing this name are backed by the specialized experience of 29 manufacturing years and by laboratory *life tests* for performance — a guarantee of outstanding performance on the job.

*demand*

MICA  
PAPER  
DYKANOL  
WET & DRY  
ELECTROLYTICS

**CORNELL-  
DUBILIER**  
*a great name  
in capacitors*



**CORNELL-DUBILIER  
ELECTRIC CORPORATION**

1013 Hamilton Boulevard, South Plainfield, New Jersey

Cable Address: "CORDU"

# ABBOTT • DK2 •

## 2½ METER TRANSCIEVER

For a change try 112 MC. You will enjoy it

List Price **\$27.50**

Less Tubes and Batteries

40% Discount to Amateurs

**GENERAL:** The DK2 is a completely self-contained 112 mc radiophone transmitter and receiver, for use in your car, plane, boat, or while being carried, for portable work. It is very simple to operate. The working range is between 2 to 30 miles depending on the location. Astonishing results have been obtained.

### SPECIFICATIONS

**CASE:** Size 11½" long x 9½" high x 6½" wide, grey wrinkle finish metal, heavy leather handle. All batteries are self-contained in case. Removable side panel for easy access to the batteries and tubes.

**FREQUENCY:** Will cover 112 mc to 118 mc (amateur 2.5 meter band).

**BATTERY REQUIREMENTS:** Three 45 volt B batteries like Burgess 5308; and four No. 6 dry cells, or two Burgess 2F2H batteries.

**TUBES USED:** One type 6J5GTX, one type 6G6G.

**SHIPPING WEIGHT:** 12 pounds.

Order from your nearest distributor — if not yet stocked we will temporarily fill orders direct

BULLETIN ON REQUEST

**ABBOTT INSTRUMENT, INC.**

51 Vesey Street

New York City

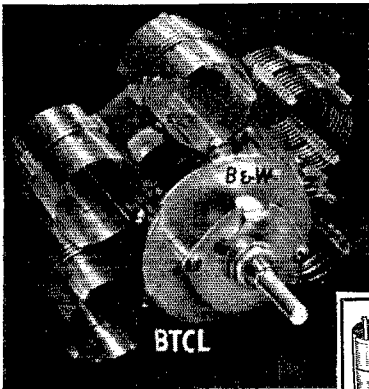

**YOU  
SAVE  
3  
WAYS!**

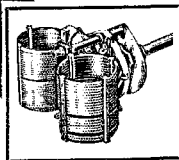

... and the  
**"BAND-HOPPER"**

(Type 2A Switch)  
A new, very small unit for low-powered capacity coupled stages, combining the speed and convenience of individual coils with front-of-panel control. Covers 10- to 160-meter bands, measures only 2½" x 3" x 2½". Amateur Net, \$3.25.

### ... with BABY TURRETS

**TIME SAVERS!**... Five B&W Baby Coils, mounted as an integral part of the switch of these new 35-Watt Turrets, provide efficient front-of-panel coverage of the 10- to 160-meter bands. No wasted time, no lost motion, no coil changing!

**SPACE SAVERS!**... The unusually small size of B&W Baby Coils makes possible a compact 5-hand Turret requiring only slightly more space than an ordinary individual coil and socket!

**MONEY SAVERS!**... Four types of Baby Turrets provide practical band-switching in all low-power transmitter and exciter stage applications. All types deliver maximum efficiency with a minimum number of tubes. Complete, including an etched aluminum frequency-marked dial plate. \$8.50 Net

**BARKER & WILLIAMSON**

Radio Manufacturing Engineers • ARDMORE, PENNSYLVANIA

## The U. H. F. Relay

(Continued from page 27)

worked hard prior to the relay lining up routes westward. He heard W8QDU using c.w., but was unable to raise him Saturday evening. W8CFD was heard briefly. W1KIK/1 heard W3AC/3 and W3AIR direct and handled a nice bunch of traffic. Between June and August W1KLJ has worked 134 different 5-meter stations in 18 states (seven districts). The important route from Detroit to Chicago was open for the entire relay period. Messages were exchanged by 5-meter amateur radio between the respective F.C.C. offices. W8CVQ (Kalamazoo) worked W9VHG six times, W8MDA (Ann Arbor) seven times and W8QDU (Detroit) eleven times in the relay. W8CIR's longest relay was Aliquippa-Detroit (200 miles), using 200 watts to a 7-element Yagi beam. He used a 4-tube acorn converter and RME69.

It has been fascinating and interesting to see the message copies roll in to be clipped together to make a complete record of each route. We regret some of the gaps that cannot be filled because a few fellows failed to report. There were dozens of messages, and since many wonder how they progressed, we include information reaching us. W3FBH's message to Maine got as far as W1KIK/1. W1KUD's, W1SI's and W1KEE's have been traced as far as W3HOH. One from W1JUJ, Sanford, Maine, likewise. Another started by him got to W1KLJ and W1LLL. W1ERT's got to W3AC/3. W1EHT's, W3ETA/8's, W2ADW's, W3EUA's and W1AUN's got as far as W3GGR OK. We never got beyond W8NYD in tracing those from W8MDA, W8GRP, W8LMP, W8QQS, W8QDU, W8JLQ, W8RKE, W8TBN/8 and W8RFW. W3IDS, W1KH and W1HXU got messages as far as W1EKT, after which no further reports. W3HPD, W1IUD and W1JSV messages got to W1KIK/1. W2MEU got a message through to W1HDQ. W3AC/3's, W3HHC's and W3HPD's got to W3ETA/8. W3HSN's got to W3DBC. W2LEG's was delivered at W3BYF. W2NF's, W3FJI's, W1CLH's and W1BDI's got to W3BKB en route west.

The spirit of all participants was high. It was great fun, and a thrill of accomplishment to hear about the routes being set up, and pass along messages to well known friends or hear them on their way.

Typical comment: "Orchids to W8CIR for his fine work in attempting to bridge the gap west during the contest." — W3FQS. "Everyone taking part had the time of his life. . . . Used a beam with eight half-wave elements here." — W8CVQ. "Heard W5EHM testing on 56.2 Mc. and am reporting this to him." — W3EUA. "More activity on the band than for many a day." "Relay work is the answer to keeping five meters open. The messages slid up and down the coast as if 'five' had been used for this purpose for years. Don't let anyone tell you the boys on this band cannot handle traffic." — W1J. "Most activity at the start and at the end." — W3HOH. "Will stay on throughout the winter. All set for all districts, and

**MORE PERFORMANCE FOR LESS MONEY**

*Here's the buy!*  
**U50**  
 Super

**11 tube  
 COMMUNICATION  
 RECEIVER**

**\$69<sup>98</sup>**

Amateurs Net  
 Wired with Tubes



**ILLUMINATED  
 GUN-SIGHT  
 DIAL**  
 Magnifies  
 2 1/2 Times

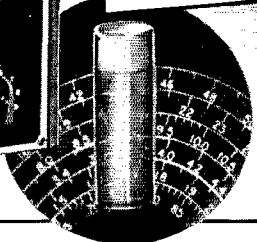

**BUILD IT YOURSELF**

KIT supplied assembled,  
 ready to wire \$49.95

Every year ONE communications set pushes out in front . . . because it has what it takes, in performance and Extra Value. We believe that during the coming year it may well be the GUTHMAN 11-tube U-50 SUPER.

Complete with new Gun-Sight Tuning Pre-Selection Stage, this new receiver provides quiet DX thru controlled regeneration, and socket provision for adding 100 kc. oscillator giving in-built frequency check.

U-50K SUPER, assembled, ready-to-wire, less cabinet, tubes, speaker . . . . .	\$83.25 list	\$49.95 net
U-50W SUPER WIRED, less cabinet, tubes, speaker . . . . .	95.75 list	57.45 net
U-51 Hinged top Cabinet . . . . .	5.84 list	3.50 net
U-42 10" Speaker and Cabinet . . . . .	16.50 list	9.90 net
U-53 Tube Kit . . . . .	15.05 list	9.03 net

See it at your jobber's today, or order direct, giving jobber's name if out of stock.

**CHECK THESE FEATURES**

- Six bands, 525 to 62,000 kc.
- Gun-Sight Tuning, Illuminated and Magnified 2 1/2 times
- Socket Provision for 100 kc. Oscillator to be added
- Controlled Regeneration
- R.F. Stage (3-gang condenser)
- Improved Noise Silencer
- Calibrated S-Meter
- Antenna Trimmer
- 12 Watts Output
- Matched Dynamic 10" Speaker
- AND every other Vital Control

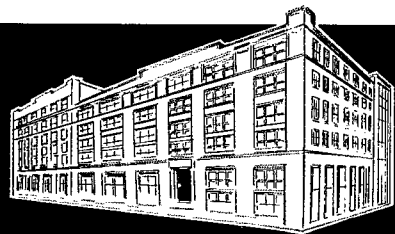

**EDWIN I. Guthman & CO., INC.**

400 S. PEORIA ST. CHICAGO, U. S. A. GUTHCO-CHICAGO

CABLE ADDRESS:

GUTHCO-CHICAGO

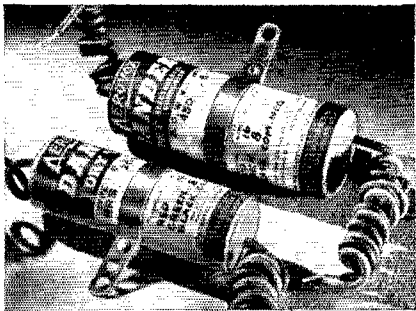

Low-cost dual-section midget electrolytics.

Extremely compact for tight spots.

25, 50, 150, 200 and 450 v. D.C.W.

8-8 to 20-20, in various popular combinations.

Center strap mounting. Polarity-colored leads.

*So Small  
but...*

● These dual midget-type electrolytics are now listed in the 1940 AEROVOX catalog, along with many other new items.

● Ask your local jobber for your copy. ● Or write us direct.



## MORE DX LESS NOISE!

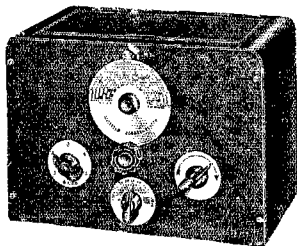

### WITH THE AMAZING NEW BROWNING PRESELECTOR

W2APT says... "In the past 15 days I have logged 23 Asians, working 19 of them... couldn't even be heard without the preselector... Extremely grateful for wonderful performance of this unit..."

This new Preselector is GUARANTEED to improve the performance of any Receiver. Available in kit form at \$13.50 or wired and tested with Filament Transformer \$16.50. Uses new 1852 tube in High-Gain circuit. Range from 5 to 160 meters bandswitching. Buy one today on money-back-if-not-satisfied basis at your local Ham Supply House, or write direct. Free Bulletin upon request.

**NEW BROWNING VISUAL FREQUENCY MONITOR**  
The new Browning Visual Frequency Monitor compares favorably with \$400 models. Exceptionally accurate and indispensable for logging DX stations and working "close to the edge" of the band. Ideal when used with E.C. operation. Many outstanding features. Amateur net price (Less 5 tubes) only \$27.45.

**BROWNING LABORATORIES**  
**WINCHESTER, MASS.**

Export Dept. 461-4th Av., New York, N. Y., U.S.A.

to shoot for that A.R.R.L.-M.R.A.C. Cup, with antennas good for all districts." — *WIKLJ*. "The u.h.f. relay idea is catching on fine." — *WIDCH*. "The volume of traffic was pleasing here in the middle west." — *W8MDA*. "Signals were normal the first day, but went below normal September 10th, so we used c.w., but 'phone was fine on the 9th. This relay has been a lot of fun. Hope you promote another soon." — *W8CVQ*. "Our weak link is between Elkton and Baltimore. We must get two hams at Aberdeen to add u.h.f. gear." — *W8GGR*. "Need contacts west and south to form a net, since W9PQH has been off and haven't been able to work W9ZHB, who hears me. T-20's and 3-element rotary beam here." — *W9VHG*.

"Was in constant touch with W8NYD to the east. It was amusing when I copied three going from W8CVQ to W8MDA and then when he called me I was able to read them back to him. Enclosed 17 test message copies." — *W8QDU*. "Since the passing of summer DX, activity on '5' has been at a very low ebb — yet within an hour of the start, message routes began to take form. By midnight routes were functioning as smoothly as though customary for years." — *Ed, W1HDQ*. "It was fine. How about having one every three months for the u.h.f. bands." — *W1CLH*. "Our best DX was W1HXP with 45 watts to 807's. The beam proved very reliable for the message relays. We used crystal control on 56.7 Mc., power from four storage batteries. Thanks to the fellows in the Tri-States Radio Club for their valuable assistance. Here's to more UHF Contests." — *W3AC*.



**ALWAYS  
BE  
CAREFUL**



★ ★ ★

(A) Kill all transmitter circuits completely before touching anything behind the panel.

(B) Never wear 'phones while working on the transmitter.

(C) Never pull test arcs from transmitter tank circuits.

(D) Don't shoot trouble in a transmitter when tired or sleepy.

(E) When working on the transmitter, avoid bodily contact with metal racks or frames, radiators, damp floors or other grounded objects.

(F) Keep one hand in your pocket.

(G) Develop your own safety technique. Take time to be careful.

★ ★ ★

**Death Is Permanent!**

# SWITCH TO SAFETY

## Buy Quality Sets and Parts from NEWARK

- ★ Send 20% down payment with your order
- ★ Add 6% carrying charge to the balance
- ★ Divide into 12 monthly payments or less

### NATIONAL

NC101X or NC101XA

**\$25.80**

Only Down

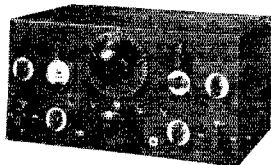

Choice of Direct Reading or Micrometer Dial. **\$129.00**  
 Cash Price.....  
**OTHER RECEIVERS AVAILABLE ON OUR FAMOUS 6% TIME PAYMENT PLAN**

ALL SETS COMPLETE READY TO USE	NATIONAL	Cash Price	Down Payment
	NC100XA.....	\$142.50	\$28.50
	NC44.....	49.50	9.90
	NC80-81X.....	99.00	19.80
	HRO De Luxe.....	179.70	35.94
Shipped in Brand New Original Unopened Factory Cartons. Order Direct from this Ad. Include sets and parts in same order on Newark's Time Payment Plan.	RME 70.....	138.60	27.72
	69.....	152.88	30.58
	70DB20 Combination.....	181.80	36.36
	HAMMARLUND HQ120.....	129.00	25.80
	<b>HALLICRAFTERS</b>		
	SX 24.....	81.50	16.30
	SX 23.....	127.50	25.50
	Sky Buddy.....	29.50	*
	Sky Champion.....	49.50	*
	Sky Rider S10.....	69.50	13.90
	Sky Rider Marine.....	64.50	12.90

\*Indicates sets sold for cash only

### AEROVOX "HYVOL"

Oil-impregnated and Wax-Filled in Rectangular Metal Cans

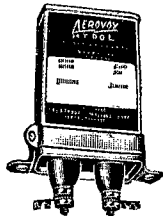

Discontinued by Aerovox. Closing out at these low Prices While Stock Lasts!

Recommended for use where economy is a necessity. Come Complete with Universal Mounting bracket as illustrated.

Type 1011 — 1000v. D.C.W.  
 Mfds. L.W.D. Net  
 1 2 1/4 x 1 13/16 x 1 1/16 \$1.08  
 2 2 1/4 x 1 13/16 x 1 1/16 1.47  
 4 4 3/4 x 2 1/4 x 1 3/16 1.96

Type 1511 — 1500v. D.C.W.  
 1 4 x 1 13/16 x 1 1/16 \$1.43  
 2 2 1/4 x 2 1/4 x 1 3/16 1.96  
 4 4 3/4 x 3 3/4 x 1 1/4 3.18

Type 2011 — 2000v. D.C.W.  
 Mfds. L.W.D. Net  
 1 3 3/4 x 2 1/4 x 1 3/16 \$1.72  
 2 4 x 3 3/4 x 1 1/4 2.40  
 4 4 x 3 3/4 x 2 1/4 4.56

Type 3011 — 3000v. D.C.W.  
 1 4 1/4 x 3 3/4 x 2 1/4 \$2.45  
 2 4 1/4 x 3 3/4 x 3 3/16 4.85

**NEW**  
 NATIONAL NC44A  
 NOW IN STOCK  
**\$49.50**

**MIMS**  
 SIGNAL SQUIRTER  
 on Easy Terms  
 only 20% Down  
 Add 6% carrying charge to balance and divide into 12 monthly payments or less.  
 Write for Prices

**FREE!**  
 NEWARK'S BIG NEW  
 84 page Catalog  
 Thousands of items for the Ham. Sets, parts, accessories and supplies fully illustrated and described, with lowest prices.

### HERE'S A REAL CABINET BARGAIN!

Again NEWARK scores with this smash value — proof of NEWARK'S "on their toes" look-out for items of merit for the Amateurs. Here's a black crackle finish heavy gauge Metal Cabinet with hinged top door, 12 3/4" high, 19" wide, 11 3/4" deep. Just the right cabinet for a 4-B table model rig or for that mobile job. We guarantee you'll like this cabinet and it's priced at a real saving. Shipping weight 16 lbs.

NO. PX-1 — Complete with front panel to match..... \$2.00  
 Chassis to fit this Cabinet, 10" x 17" x 3"..... .80

Oil Filled, Oil Impregnated FILTER CONDENSERS

Now only **69c**

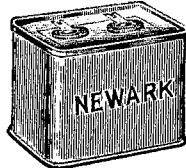

750 v. DC, 3 mid. 3 3/4 x 2 1/4 x 1 3/4.  
 Weight 3/4 lb.  
 Guaranteed at rated voltages

DC Volt	Mid.	Size	Wt.	Price
1000	2	2 3/4 x 1 3/4 x 1	1/2 lb.	\$1.00
2000	2	4 3/4 x 3 3/4 x 1 3/4	1 1/2 lbs.	1.50
1250	3	3 1/4 x 3 3/4 x 1 1/4	1 1/4 lbs.	1.25
1500	3	5 x 3 3/4 x 1 3/4	1 1/2 lbs.	1.50
1500	4,4	5 x 3 1/4 x 1 3/4	1 3/4 lbs.	1.75
1500	5	3 3/4 x 3 1/4 x 1 3/4	1 1/2 lbs.	1.90
2000	8	5 x 3 3/4 x 3 1/4	2 1/2 lbs.	2.75

These are well-known makes and only a few left of each.

### 39 YEARS TOTAL EXPERIENCE

and consistent amateur activity  
 ADDED TO NEWARK'S TECHNICAL STAFF

**A. D. Middleton**  
 "MID"  
 W9AOB

(ex. W7GLH — W4CA).  
 Well known ARRL contest "Traveler."

**G. W. Mossbarger**  
 "MOSS"  
 W9AUH

Original ORS party king and sweepstakes winner.  
 Former SCM Kentucky.  
 Member USNR.

Newark is proud to announce that these two men have been added to their technical staff and are now at your service in helping solve your amateur radio problems. Write to them.

# NEWARK

## Electric Company

323 W. MADISON ST.  
 Dept. Q CHICAGO, ILL.

# Station Activities



## NEW ENGLAND DIVISION

**C**ONNECTICUT — SCM, Frederick Ells, Jr., WICTI — Nutmeg Net: 3640 kc. 6:45 p.m. daily except Sunday. JTD, with an input of 250 watts, has a total of 71 countries to his credit. On Sept. 17th EAO worked with KXM/1, KDK, GAG and EHT/1, reporting rifle match at Hartford, Conn., and Woburn, Mass. The Conn. A.A.R.S. Net opened on Sept. 11th, with most of the old gang on hand and KYQ as new member. Sorry to hear that AJB will be inactive this year. Reed will be missed by both A.A.R.S. and Nutmeg Nets. LIM is new Willimantic ham. KAK and KYQ attended hamfest at Trumbull. TD is on 3546 kc., Mon., Wed. and Fri., from 6:30-8 p.m., looking for traffic. DWP now has an 810 final. Nominations for club officers are being held at GB. KFN has band-switching and plans a new 3.5-Mc. antenna. AVC attended DX Round-up in Springfield, Mass., with APA. ADV is building new home in Easton, and will have 1 kw. on the air when he gets moved. JBI has completed new modulator using a pair of RK12's. KWF has been busy digging holes for new masts at CBA. B.A.R.A. made an excellent showing in June Field Day. More reports from Connecticut amateurs would be appreciated. Reports from all licensed amateurs are welcomed and should reach the S.C.M. by the 19th. BDI attended the Manchester, N. H., Convention. Twelve members of the Nutmeg Net were present at a get-together held in the club rooms of N.H.A.R.A., WIGB, Sept. 23rd. A fine spirit of interest and activity was evident, which indicates that 3640 kc. will become known more than ever as the meeting place of the Nutmeggers this year. Our thanks to the N.H.A.R.A. for its fine hospitality.

Traffic: W1AW 215 (WLMK 23) EAO 26 JXP 15 BDI 6 KYQ 5 TD-DWP-KFN 2 GB-CTI 1

**MAINE** — SCM, H. W. Castner, W1IE — Your S.C.M. has been appointed on the "Planning Committee" of 75 amateurs, which is making a study of present usage and future recommendations of all our bands and privileges. The opportunity has arrived for you to write me all about what needs to be changed, improved or corrected in all our operation. A.R.R.L. has set up this study in such a way that every individual ham has a voice in all these matters. It's squarely up to you fellows. Write me any suggestions, good, bad or indifferent, and it doesn't matter in the least whether you are a League member or not. The State Commander of the American Legion has appointed Mr. Hubert W. Eldred of Bath as chairman of a Legion disaster and relief committee. It is understood that some of the Legion posts expect to maintain emergency gas-engine equipment that would be made available to Emergency Coordinators in those localities for general communication service in event of disaster. KEZ is sure "denting the ether" on 14 Mc. with those 809's. KZI has a new Gross transmitter and is doing great work. HSD has rebuilt and is getting most of the 90 watts input through to the antenna. Ben has about 10 different crystals. Charlie Mouckerizi and Dan Haynes are new hams in Millinocket. Welcome, boys. LDC is on 14 Mc. LIZ is rebuilding. JSY is to teach the science courses at Fort Fairfield High, and will be on with 150 watts from there. GXY has that beautiful new rig almost ready; Ed spoke before the Red Cross recently on our emergency work; he is building up a fine emergency plan for Bath. LHX is coming into the League. Who's next? DPJ is preparing to be O.P.S. and is also a member of the Kennebec Valley Net. KCO is now Class "A." DHH continues to do a real job. VF reports the cloudburst Aug. 21st did great damage and, as many were standing on Breakneck Brook Bridge, it washed away. Some were rescued, but Mrs. Raymond Cotton and daughter Rachel of Hiram perished in the raging waters. They were the wife and daughter of Raymond Cotton, WIBTY, whom old timers will remember as 1ALK. I express the heartfelt sympathy for every amateur in Maine. Ray, at this great tragedy. Nearly six inches of rain fell in two hours. In Baldwin and Sebago over seventeen bridges were out including a 100-foot long railroad fill. Again we say to all: Get ready for these emergencies. LWX is still going strong. MFU is on 3530 kc. with 4 watts. CRP vacationed around Stonington, and kept schedule with JRS while there. HSO

is active as always. LKP reports activity and traffic. This report reaches upwards of 400 Maine hams, and we again earnestly ask cooperation with our official activity and welcome letters and cards from you all. Advise any Legion Posts that inquire to investigate the wonderful set-up the Caldwell Post in Portland have for emergency work, which includes trained Police, Firemen, First Aid, etc., units. EWN is our E.C. and also chairman of the Caldwell Post Radio Committee. He has some 2000 watts of auxiliary power and a 1.75-Mc. Net all ready "IN CASE"!! LMQ is on 7 and 3.5 Mc. and reports the A.A.R.S. starting out with a large number of stations. MDD is new Farmington ham. LRP is active on 7236 kc. Much of the comment from the members of the "Planning Committee" is to the effect that many of the licensed amateurs don't know procedure well enough. They're right, fellers, in some respects. I know of a lot of the boys who are on 'phone that can't make up a correct message form. All of us don't know half enough "Q" signals. Many are careless in sending. Some firsts are very hard to read. Take a listen on 3.5 Mc. and see if you hear any of the boys who send fine "stuff," like 1NW. Try to get better. Let's raise the standard of efficiency in Maine. INW is the new Emergency Coördinator for Lewiston and vicinity. I hope all you boys around that locality will cooperate. KLH has applied for membership in the Pine Tree Net. Remember, these third-party messages impress citizens with our usefulness. New Emergency Coördinators: EWN, HSD, INW, IBR. Let's hear from all Maine hams. Anything you write me will receive immediate attention, and I can assure you that any ideas will be used. I have an elaborate file system and can refer to any correspondence from any of you instantly. When you write me you can be assured you're not "shouting up a blind alley."

Traffic: W1IE 2 LML 15 LMQ 5 LRP 7 LKP 2.

**EASTERN MASSACHUSETTS** — SCM, Larry Mitchell, W1HIL — Ass't S.C.M.'s: 1JJY, 1GAG. Chief R.M.: 1JJY. P.A.M.: 1GAG. New O.P.S.: KTE, LO, GCU. New O.B.S.: LMB. Prospective E.C.'s: HSR, BMW, LBY, JMJ. Another fine radio rifle meet was held on Sept. 17th between the Mass. Rifle Ass'n at Woburn and Hartford Rifle Club, Hartford, Conn. Hartford won by a score of 1470 to 1238 for Woburn. The reports, scores and data were all handled by 'phone. On Conn. end KXM/1, 1.9-Mc. 'phone to EAO West Hartford on 3.9-Mc. 'phone to GAG at Stoneham, to EHT/1 at Woburn. EHT/1, 1.9-Mc. 'phone, to GAG Stoneham, on 3.9-Mc. 'phone to EAO to KXM/1. This was very successful and enjoyed by all who took part. A large number of messages were handled between the shooters. This sort of activity does a great deal to bring amateur radio to the attention of the public, and is a different and most enjoyable form of operating. Our thanks to EAO, KXM, GAG, EHT and IN. Eastern Mass., South Shore, Waltham and Merrimack Valley Clubs report very active programs for the winter season. IYG gets out with Harvey 100-T. JCX married June 24th. Congrats, Herb. INI is with Marines at Quantico and operates 3ELN on 3800 and 7390 kc. CWZ is father of baby girl born Aug. 14th. HIL 1 operated from Harwich Port, Mass., for two weeks and made a number of fine contacts with 12 watts on 1.9- and 3.9-Mc. 'phone. HOM attended Cleveland Air Races and worked gang with UHX-10 in car. LVV is active in Haverhill. EMG keeps Melrose on traffic map. GAG with 500 watts is active on O.B.S. work on 3.9 and 14 Mc. KCT is quite active on Army Net. BB is going strong on all bands. KCQ reports Waltham Amateur Radio Ass'n has 300-watt club station. LO reports GUI back on 28 Mc. LTC has new 500-watt rig. LMB decides to try O.B.S. work on 28 Mc. LEU has Collins kw. rig with 4-element beam. GFW raises power. RHW has new rig. ATK is in Veterans Hospital at Rutland, Mass. Drop him a card, gang. The Eastern Mass. 1.75-Mc. 'phone Army Net had first drill, Sept. 17th, with 14 stations on the net freq. of 1985 kc. More members are wanted. Contact EGR for details. All A.A.R.S. men, please report your traffic to me each month for inclusion in QST. LOI will be on 14-Mc. 'phone soon. LXQ and KYN keep Newburyport on the air. JNU of Methuen is active on 1.75-Mc. 'phone. BHW sends in nice O.O. report. KTE handles traffic on 3.9-Mc. 'phone. LMO was runner-up in F.T.S. contest. HSA has 500 watts on 7 Mc. AGX reports A.A.R.S. North Shore 56-Mc. Net started up Sept. 11th; meets at 7 p.m. daily. BDU is very active on F.T.S. WV worked KA1ER, LZ1HD, XU8MI and CT4AA for 117th, 118th, 119th and 120th countries. The Mystic Valley Radio Club meets every Thurs., Room 8, Pythian Bldg., Malden.

JJY is active with traffic and lining up Emergency Coördinators. JRC is now on 28-Mc. 'phone. MFC, ex-3GZK, is most welcome addition to E. Mass. KH says no more B.P.L., as VO3A is now off. LNN reports LSA and MEZ on 1.75 Mc. BFR is now first-class telephone opr. LXX sends first report. QW reports general overhaul for winter season. KZK, LIU, EAQ, GRV, LTI, IZK, LEJ, KIT, AAT, AYD, LXW, JEF, HJU, IF, BVL, LBS, KJA, IYW and LWH are on 28 Mc. 'phone in and around Beverly. Let's go for a real season, gang. Please report all activity. 73 from Larry, Kay and Bud.

Traffic: W1LWH 256 KH 197 JJY 142 JCK 113 (W1GV 79) LBY 94 KZT 76 BDU 67 JSM 49 EMG 42 LMO 38 AGX 36 GAG 32 EHT 26 KCT 24 BMW 17 HWE 16 BB 14 KTE 10 HSA 4 LNN 2 LXX-KCQ-LMB 1. (July-Aug.: W1JSM/1 69 KCT 21 W1 J.)

WESTERN MASSACHUSETTS — SCM, William J. Barrett, W1JAH — LDV and LJJ are new O.R.S. HDQ is new O.P.S. IOZ applied for O.O. LDV leads the traffic parade this month — nice going, Bob. BIV is awaiting full swing in A.A.R.S. JAH visited BVR, KUW and BIV. AZW applied for O.R.S. DUZ and FOI keep the 'phones represented in the traffic column. DUZ reports that the West. Mass. A.A.R.S. 'Phone Net is all set for the active season. LDE has been working 14-Mc. c.w. BNI has been concentrating on rebuilding in preparation for the coming winter. COI took down rhombic antenna to make way for new rotary. How about some reports to help fill this column, fellows?

Traffic: W1LDV 120 BIV 57 JAH 54 (W1GH 9) BVR 17 (W1G 138) FOI 12 DUZ 4.

NEW HAMPSHIRE — SCM, Carl B. Evans, W1BFT/DMD — The Sixth Annual N. H. State A.R.R.L. Convention and Hamfest was held in Manchester on Sept. 23rd, with an attendance of approximately 275 hams from all over New England. From all reports a good time was enjoyed by everyone. The Frequency Modulation demonstration by G. E. was particularly interesting. Most of the boys visited the Smyth Tower, the new home of the Manchester Radio Club, W1LYK, the sponsors of the hamfest. The New Hampshire Net started up Oct. 2nd on 3600 kc., with a possible shift back to 3840 kc. if QRM is too heavy. The M.V.A.R.A. is planning some intensive work on "2½ meters" and would like to collaborate with other "2½-meter" stations throughout the state. JBA/1 is at the Univ. of N. H. in Durham for the winter. JCA returned from a U.S.N.R. cruise on the U.S.S. *Wyoming*. The St. Paul's School Radio Club is active again, with the boys back for the fall season. GVV, formerly from Vermont, is now located in Laconia where he is teaching school. IDQ is going to California soon. Only one report was received by your S.C.M. this month. He would appreciate it very much if you fellows would drop him a line, occasionally, with a few items of interest to use in the QST reports.

Traffic: W1KIN 115.

RHODE ISLAND — SCM, Clayton C. Gordon, W1HRC — QR is keeping nightly schedules with W1LEW/NAE at 7 P.M. KRQ is on A.A.R.S. from Westerly, and BOY and AOP from Pawtucket. KYK, LDL and KOG are new A.A.R.S. Control stations. LWA is in A.A.R.S. from Providence. 2JDE was portable in Newport during August. BVI has installed peak-limiter in 'phone rig. So has JNO, who also has up a 28-Mc. vertical antenna and is using e.c.o. on 1.75 Mc., and says it's very satisfactory. MCN is new Providence ham with a 3-tube regenerative receiver and '47 crystal and 6L6 amp. on 3.5 and 7 Mc. DDD has Hetrofil assembled. IZO has been on 112- and 28-Mc. 'phone, and is experimenting with antennas. He and CAB worked 3.5- and 7-Mc. portable at Point Judith N.C.R. outing, with 19 ham members attending. JEZ is working on 112-Mc. transceivers for emergency work. CNJ is on 14 Mc. JXQ has new e.c.o. for skidding around 3.5 and 7 Mc. LQL has new 34-ft. pole for antenna and 300 watts 'phone and c.w. on 1.75 Mc. LWA built new 6KT7 e.c.o. and 6L6 final. LDL built up a 6SK7 e.c.o. per QST, and says it works FB keying the oscillator. MEK is new ham in East Providence on 3.5 Mc. MBM is using 6A6 osc., 6L6 doubler, 809 final. POF has arisen from the ashes of forgotten handom to reappear on 7 Mc., proving that marriage is tough on Hamchewers but not fatal. JHB has pair of T40's on 112 Mc. JP has new final (HK24's) on 56 and 28 Mc. JP is the life behind this report since he took it upon himself to gather all the news.

Traffic: W1KYK 77 INU 49 JXQ 26 GTN 24 CPV 16 INT 15 KWA 13 QR 5.

VERMONT — SCM, Clifton G. Parker, W1KJG — KWB is now in East Barnet. GAN was visited by 2LEJ and visited 1DQA, FBJ and FCE while through New England. GVV is now teaching in N. H. KXL is newest A.A.R.S. recruit in Vermont. KXY on latest dope is staying with us; FB! KJG was visited by JRU, KUY and KWQ from Conn. JLF rebuilt his 1.75-Mc. 'phone outfit and is now in new quarters at 29 Perkins St., St. Johnsbury. BNS rebuilt with T55 final. CBW has new 150-watt 1.75-Mc. 'phone ready. LVI, formerly of Saugus, Mass., is now located in St. Johnsbury and is teaching at Fairbanks Vocational School. IDM is on 1.75-Mc. 'phone. JRU erected new spread-leg mast atop his garage. A.A.R.S. Net has resumed fall activity. KVB is operating portable in Arlington Hts., Mass., on 7 Mc., and likes to contact the Vermont gang. FPS has emergency outfit with 6C5-6I6 with Vibrapak supply. IZO has his 200-watt battery-powered transmitter ready for the air. GAE and BZS are doing research on 112 Mc. Your S.C.M. is certain that much more traffic is being handled than is being reported — yet it cannot be included unless you report it — please try to get those reports in here promptly after the 15th.

Traffic: W1JRU 2 KJG 23 KXY 4 FSV 36.

## ROANOKE DIVISION

NORTH CAROLINA — SCM, W. J. Wortman, W4CYB — The A.A.R.S. got off to a good start, and various networks have begun to function in the State. DLX, R.M., has put forward a request for some interested fellows to line up some schedules with him to facilitate the delivery of traffic over North Carolina. Drop DLX or your S.C.M. a card if interested. BHR has lined up some schedules that are beginning to function. FLC, new O.R.S., is ready for action. DQ is installing new skywire. DGV rag chews most of the time. BV has new speech equipment. MR is working 14 Mc., with two directional antennas. ZH has new 'phone rig on 1933 kc. TJ returned to 3.9 Mc. after his having permanently moved to 14 Mc. CPV sends nice list of DX. AKC leads State in traffic this month. FB, Joe. FCB reports from Schofield Barracks as a portable K6 and worked PL via K6QUJ. FUA has new modulation meter for checking rig located in attic. EIZ is building portable for use at Duke Univ. EYF and DLX have emergency transmitters. New members in Emergency Corps are FYP and DLX. How about sending in some of the blanks given out in Greensboro? We have been asked by BMR to retract our last month's statement to the effect that he had four 250TH's in P.P. parallel. Our apologies for an incorrect statement. DGU enjoyed trip to 2USA and up into Canada. ANU has new combination 14-3.9 Mc. antennae. AAU returned to 3.9 Mc. We want to thank the gang over in Greensboro for the nice hamfest held September 2nd. Prepare now to go to Charlotte, November 5th.

Traffic: W4AKC 166 DLX 15 DSY 15 TJ 2 DGV 1.

SOUTH CAROLINA — SCM, Ted Ferguson, W4BQE/ANG — AZT is active on 3.9-Mc. 'phone. DRE reports rig working FB on 7024 kc. FXH is active on 3.5 Mc. CQU has regular schedules with DXF. CE has new rig with T40 in final, both 'phone and c.w. COL has returned to Clemson. GAR changed QTH to Denmark. CXO is rebuilding for 14-Mc. 'phone. FFO changed QTH to Clemson. EZF is active in 1.75-Mc. 'phone net and makes nice report of the activity up-state. Thanks, OM. FYL and EZF attended the 'fest at Athens, Ga., and report nice time. GCW returned from Michigan. FNC and EJK are old standbys on the 1.75-Mc. net. CSP operates 1.75-Mc. 'phone. FVF has a new Jr. op. Congrats, OM. CPB and CEL are organizing a club at Greenville. Nice going, fellows. EDQ changed QTH to Greenville. BVI is active on 1.75-Mc. 'phone. EXJ can be heard on 7-Mc. c.w. and 1.75-Mc. 'phone. CZA reports activity in the A.A.R.S. and T.L. "C". CZN no longer pounds brass for "Uncle Sam" but is taking care of the Ga. "peaches." EMT can be heard on 7 and 14 Mc. with 140 watts to T-20's.

Traffic: W4CZA 22 FXH 18 AZT 14 GAR-EXJ 7 EZF 4 ETG-DRE 2 CE 1.

VIRGINIA — SCM, Charles M. Waff, Jr., W3UVA — R.M.'s: 3GTS, 3HDQ. P.A.M.'s: 3AIJ, 3GWQ. FHF plans to be on 4-Mc. 'phone. CSY is N.C.S. for the Old Dominion Radio Ass'n. HAE reports the Norfolk Radio Club very active. John Huntoon, 1LVQ, of A.R.R.L. HQ's staff, visited Petersburg, Richmond and Norfolk clubs. We have word

(Continued on page 104)



Here is HOW—

You can train for a better job and more money in

## Radio & Television

H. R. Rietske  
Pres. CREI

Insure your future in this expanding field

Why should you let new men come in and get the good jobs in Radio and Television? Your own valuable experience coupled with the modern technical training made available by CREI — will equip you to step into the big jobs that demand trained men. There's a real future for those who plan their future right now!

Men with Technical Training  
Get better jobs — more money

Right now is the time for you to start training for more money and a better job. CREI offers you a practical, thorough home-study course in Radio and Television Engineering. Write today for our interesting booklet — you'll thank us many times after reading its 48 pages.

More than  
300  
Broadcasting  
Stations  
Employ  
CREI Men

TEAR OUT COUPON AND MAIL FOR FREE BOOK

**FREE!** Please send me your new illustrated book, "A Tested Plan for a Future in Radio"

Name .....  
Address .....  
City .....



Capitol Radio Engineering Institute  
Dept. Q-11, 3224 16th St., N.W., Washington, D. C.

## Hints and Kinks

(Continued from page 64)

the measurement cell of our watt meter. Part has been dissipated in the associated tuned circuit and connecting wires. Assuming that the power consumed by each of several loads on a transmitter is proportional to the increase in final plate current which the connection of each load produces, we can set up this proportion.  $\frac{W_t}{W_a} = \frac{I_f - I_u}{I_f - I_t}$

where  $W_t$  is the true power output,  $W_a$  is the apparent power output,  $I_f$  is the average final plate current under full load,  $I_u$  is the final plate current under no load, and  $I_t$  is the final plate current with only the tuned circuit and connectors as load, that is, with the cell disconnected. In the case we have been following,  $I_f$  is 151 ma.,  $I_u$  is 34 ma., and  $I_t$  is 53 ma. Substituting and solving we get 87.4 watts for the true power output of the transmitter.

A second and third trial of the experiment gave us values of 89.0 watts and 89.2 watts respectively. On the basis of these measurements, we accepted 89 watts as the power output of our transmitter on 20 meters. All three measurements and calculations were made in a space of two hours one evening.

In summary, the calorimeter type radio-frequency watt meter is simple and inexpensive to construct. The observations and calculations are not difficult to make. And the results obtained are of satisfying accuracy.

— Robert L. Ebel, W8RSC

## Cathode Modulation

(Continued from page 26)

used since its grid comes out below the chassis where all the a.f. circuits are kept, to shield them from r.f. fields.

All r.f. circuits, except the final grid tank and neutralizing condensers, are kept above the chassis. There is no evidence of r.f. feedback even though the entire audio system is mounted next to the Class C stage. It will be noted that the negative returns of the audio circuits are insulated from the chassis and returned to switch  $SW_4$ , mounted on the volume control, so that the modulator and speech amplifier may be turned off for c.w. operation. The secondary of the CM-15 modulation transformer was connected for an impedance of 1500 ohms, which in conjunction with a Class C grid leak of 20,000 ohms, gave a proper balance between grid and plate modulation for the T20's being used.

The filament by-pass condensers used in the cathode-modulated Class C stage should not exceed a value of 0.002  $\mu$ fd., and no other stages should be supplied from this transformer. Resistor  $R_{17}$  in the cathode return of the Class C stage may be bypassed for audio frequencies, if desired, with an 8- $\mu$ fd. condenser. This will not add to the quality of the modulation, but will result in a slight saving of audio power.

SUPER ACTIVE

# HIPOWER

LOW DRIFT  
CRYSTAL UNITS  
HIPOWER  
"RUBIES"

Highest degree accuracy, precision cut, finest Brazilian Quartz—Hipower "Rubies" deliver max. performance.  
Complete Crystal Units  
160-80-40 meter bands.....\$4.50  
20 meter bands ..... 7.25  
Temp. coefficient 4 cycles or less per M C per °C.

HIPOWER  
"EMERALDS"

Not "X" cuts—not "Y" cuts—but high quality low drift crystals at "X" and "Y" cut prices. Large production facilities and an exclusive Hipower method of grinding brings you these units at the sensational low prices shown here.

Complete Crystal Units  
160-80-40 meter bands .....\$3.35  
20 meter bands ..... 5.50  
Temp. coefficient 10 cycles or less per M C per °C.

At your parts distributor. Catalog sent on request.  
Newark Electric Co., Chicago, now has full line.

## HIPOWER CRYSTAL COMPANY

2035 CHARLESTON ST.

CHICAGO, ILL.





## Selects **BURGESS** for its Emergency Radio —where *“Possibility of failure cannot be risked”*

“United” won the Aviation Maintenance Award for 1938. And, here’s one of the precautions that typifies the Air Lines’ safety mindedness.

The picture shows Al Otvos, radio mechanic, installing a No. 3T10 Burgess Battery on a DC3 Mainliner’s Emergency Radio. This set is a 4-tube, tuned frequency model which is standard equipment on all United’s planes.

A letter from the company says, “The importance of the emergency radio is obvious . . . The possibility of failure cannot be risked on any occasion—and that is why Burgess batteries were selected.”

Again Burgess batteries have been chosen for their dependability. Whatever your requirements are, you too will be safe with Burgess.

BURGESS BATTERY COMPANY  
FREEPORT, ILL.

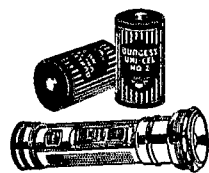

# BURGESS

(Continued from page 101)

that a club has been organized at Fredericksburg; meetings are held weekly in a clubhouse donated by the City of Fredericksburg; several transmitters and receivers are in use by the club under 3IKK, FB, OM's! IBV and IHN are new Fredericksburg hams. KR is a member of the A.A.R.S. GWQ now has P.P. T40's and Class B modulation. FMY has 1-w.s. 'phone-c.w. on all bands. ALF needs New Mexico for W.A.S. BIG, AIJ and BTM are members of the Army 'phone net. Other 4 Mc. 'phone amateurs are joining soon. Those interested write BTM. ELN now has two new operators. HNX has new Class A ticket. Congrats! HDQ invites all traffic-minded hams to join the VIRGINIA TRAFFIC NET. HWJ is ex-4EMJ, ex-5EQD and ex-9QKK; HWJ is a Captain in the Army Air Corps at Langley Field. IFZ is an associate of Trunk Line "C". EDG is new O.R.S. After a dozen or so years of inactivity, DL has become relicensed with a Class A ticket and will operate from the Engineering Building, U. of Va.; DL is Ass't Prof. of Elec. Eng. BFW is working all bands. HBF finished new rig with P.P. 809's. UVA has 78 countries confirmed. HXD has a T55 on 14 Mc. HAO has his rig located on Belle Isle in the James River at the WRD transmitter; you'll hear Carl most any time of day or night on 4-Mc. 'phone. GSV and ICQ are new Emergency Coordinators for Hilton Village and Cape Charles, respectively. If your city or town has no E.C., write to the S.C.M. for particulars. WE NEED MORE EMERGENCY COORDINATORS IN VIRGINIA! Amateurs in Newport News, Lynchburg, Danville, Roanoke, Bristol, Alexandria, Fredericksburg, Harrisonburg, Winchester, Petersburg, Hopewell, etc., kindly note as no E.C. is appointed in any of these cities and many others as well. Information on the various nets in Virginia will be furnished upon request by the S.C.M. These include Virginia Traffic Net (3.5 Mc.), A.A.R.S. (3.5 Mc.), A.A.R.S. (4-Mc 'phone), Virginia 'Phone Net (4-Mc. 'phone), Old Dominion Net (2-Mc. 'phone), Zertz Net (7 Mc.), Sewing Circle Net (2-Mc. 'phone), and Old Dominion Radio Association (7 Mc. for Negro hams). All these nets are active and invite newcomers who can qualify. Don't forget to REPORT PROMPTLY ON THE 16TH.

Traffic: W8ELN 268 HBH/IFZ 64 HDQ 56 CSY 33 KR 14 ALF 7 FMY 5 BFW-HAE-HAO 2.

WEST VIRGINIA — SCM, C. S. Hoffmann, Jr., W8HD — PZT is using antenna dope obtained from 3ZA at Convention, on his 1.75-Mc. 'phone, and it works FB, TCP and RJG attended Central Div. Convention at Columbus. KSI married and visited 2USA on honeymoon. PQQ has worked 101 countries, with new cards from J9CA, LX1RB and VP8AD. BTV and TLD QSO'd LCN from 9FA, Denver. DFC is grooming for winter traffic schedules. JM finally made W.A.S.! The gang reported working at State Police radio stations: At WFWV, BOW and DMF; at WMWV, SBW and PMA. TCP visited THR, MXW, DXB, LEN and EGZ on vacation. SPY and TNC operated portable at Wint's Gap, Pa., during U. H. F. Field Day. SPY has Radio Telegraph First and Class A tickets; he is on 14-Mc. 'phone. CIR reports he can hear TNC on u.h.f. KWL has new 56-Mc. portable. TNC/RFP is experimenting on "1.25 meters," with pair of WE316A's. TOK schedules KCY and QWM. Report of Mountaineer Amateur Radio Assn. field day activities, reported in this column recently under call of 8ASI/8, should have been 8JKN/8. PSR is N.C.S. of W. Va. Net.

Traffic: W8PSR 24 DFC 12 TOK 8 LCN 6 KSI 4.

#### HUDSON DIVISION

EASTERN NEW YORK — SCM, Robert E. Haight, W2LU — LSD is going strong with F.T.S., working approximately 182 stations on F.T.S. schedules. KWG continues keeping West Point on the air, LU is on 3530 kc. looking for E.N.Y. stations. MHW is working W.N.Y. and E.N.Y. traffic nets on 3720 kc. DVC sports new Howard. KFB is back on 3.5 Mc. LLU reports total of 55 contacts. MHW, new O.R.S., reports GTW at sea operating on Limer 'herokee. LOR is overhauling rig while KXF rebuilds his station receiver. LRW of Ghent, pinch-hitting at WOKO and WABY, uses portable at Albany. BEW paid LU a visit, discussing E.C. activities in his district. EMK is new O.R.S. HXQ has been doing a swell job at 2USA. E.N.Y. is proud to have Kay in our Section.

Traffic: W2LSD 154 KWG 64 LU 47 MHW 6 DVC 3 KFB 2 LLU 1.

NEW YORK CITY AND LONG ISLAND — SCM,

E. L. Baunach, W2AZV — New appointments: LGK O.R.S., JIQ O.B.S. KJY reports from L.A., where he is operating portable from the trailer, "Continental Clipper," which carries radio WILSV. MMC is a new station at 45-66 159th St., Flushing. BYL is now located at 75-56 184th St., Flushing. EXR's new QTH: 1910 McGraw Ave., Bronx. IYR is now at 1303 Dean St., Brooklyn, but will be operating portable from Syracuse for the rest of the year. APT is operating portable in Oregon. KWQ is getting out FB with the new rig. MCI operates on 7-Mc. Traffic Net. LTG is giving 14 Mc. a try. KYO received his A-1 operator's certificate. JUI is building for 28-Mc. 'phone. KMZ received his second-class telegraph ticket. LOQ received his third-class telegraph ticket. LNN received his Class "A" ticket. KI is ready for big season. ELK's new transmitter is all built, with the latest safety devices. LGK did a lot of 56-Mc. DX listening. Both KHI and KMZ are working on 56-Mc. rigs. LPJ increased power to 250 watts and is on the F.T.S. with AEU. LZR is official F.T.S. BC station and is on every Friday at 7:30 p.m. E.S.T. on 7200 kc. DBQ is looking for members for A.A.R.S. 7-Mc. Net. EC reports that the A.-P. trunk line is now operating Monday through Friday on 3630 kc. at 9:30 p.m. E.S.T., and anyone with traffic can call in and give it to one of the members for delivery to the west coast. IOP is going in for some extensive rebuilding. PF started on his fifteenth year of A.A.R.S. operation, Sept. 11th; while away at the Army maneuvers he conducted some airplane-ground tests with beam antennas, with very interesting results. EYA has plenty of DX cards waiting for the gang. Send a self-addressed stamped envelope if you expect any. AXZ is on 7000 kc. every night at 6 p.m. E.S.T. The N.Y.C. and L.I. Section Net is going very successfully every night on 3710 kc. at 8:30 p.m. LR, the control station, and ITX, alternate, are looking for more stations to join in. AZM conducts the emergency drill on that frequency on Wednesdays. All stations in the Section are most welcome. The Queens Radio Amateurs celebrated their first anniversary at a dinner, Sept. 8th. It was attended by LPJ, CWE, LEA, CKQ, KFW, LUX, LGS, KXG, KCH, AOD, GXC, GGN, LES and F. Wessely. AEU has organized the TENMEN Radio Club in the Flatbush and Gravesend sections of Brooklyn.

Traffic: W2SC 524 LZR 363 HMJ 258 LOQ 135 ITX 99 (WLIN 79) AZV 89 LPJ 93 IOP 55 AEU 43 KI 42 AXZ 38 DBQ 35 (WLNB 58) LGK 36 LBI 30 EC 24 FAQ-CET 11 HYL 10 BNJ-CCD 9 CEN-BYL 7 PF-AHG 6 KYV-LID 5 AA 4 GRJ-LNN-ADW 3 HGO-FF-BGO-DMM 2 CIT 1.

NORTHERN NEW JERSEY — SCM, Joseph P. Jessup, W2GVZ — R.M.'s: 2BCX, 2CGG, 2GVZ. P.A.M.: 2HNP. Section net frequency: 3630 kc. New appointments: O.R.S. — JKH, JKG, JUU, LXI, 5HUH/2; O.P.S. — DVU; E.C.'s — KTR Perth Amboy, HNT Leonia. KMI, proud pop of new Jr. op., is now located in Hasbrouck Heights. DVU returned to N. J. from L. I., and is in full swing at Montclair. 5HUH/2 came to Fort Monmouth and will be active in traffic and A.A.R.S. JUU is snagging elusive messages on 7040 kc. MFF is new Clifton ham. The Clifton Radio Club planned a shindig at High Point. MEW is on 7 Mc. HXI made W.A.S., after a tough five-year struggle. FB! JSF returned to the fold after operating portable at Watertown, N. Y. and working the boys back home on 20 watts. JKG is still at Yale with 6L6-809. BCX is giving up T.L. "L," and a new station is needed for Eastern end. Please remember that monthly reports are expected from all appointees and are evidence of continuing active operation. The cigars are on GNQ for making the DX C.C. ARB is also close to making C.C. In case you are in doubt, N.N.J. takes in the following counties: Bergen, Passaic, Essex, Union, Middlesex, Monmouth, Hudson and Ocean. KYH is active on 1.75-Mc. 'phone and heads the N.C.R. unit at Paterson. GFW rebuilt the heap for GWJ. GVZ put up 3-element 14- and 28-Mc. rotary, and expects to use it chiefly as a weathervane. JKH hopes to beat GSA in next SS contest. MKW is new Bayonne ham. KHA and HCO are back for the traffic season. LMN joined A.A.R.S. and is also on N.N.J. Net. HTL is on 28-Mc. 'phone. KTR joined N.C.R.

Traffic: W2LMN 110 GVZ 72 (WLNI 26) JUU 41 MEO 34 KTR 15 JKH 8 KHA 3.

#### ATLANTIC DIVISION

EASTERN PENNSYLVANIA — SCM, Jerry Mathis, W3BES — 3AKB has resumed full fall schedules.

Advise 3AQN of your schedules. 3BES has new QTH. 3BXE, O.R.S. of old, is at it again, this time with an 809 and e.o.o. 3CHH is building transmitters for others. 3DPU, E.C. for Phila., is on with a 100-watt e.o.o. from new QTH. From Jacksonville, Fla. to Drexel Hill, Pa., and back in five minutes is a traffic record set by 3FLH. FB1 3FRY, vigilant O.O., is keeping a weather "ear" open for offenders of all kinds. 3GDI likes his O.R.S. so well he has signed up for his fourth year. 3GHD is nearing his goal of Century Club. 3GHH has started training for the Sweepstakes. 3GKO's new QTH has not bothered his traffic efforts. 3HFE, QV, GNA, AJF and BSD handled the 56-Mc. mobile at the motorcycle hill-climb and race held at the Langhorne race track over Labor Day. 3HYD has succumbed to e.o.o. Look out! 3HZK got a bug! 3IAY finds the General Traffic Hour profitable. 3QP's KA schedule clicked 30 days out of 39. 3RR's e.o.o. has boosted his traffic in spite of curtailed operating hours. Lightning proved to be tougher than 8LZD's rig; he now has 20 watts. Unit 3, Section V, U.S.N.R., solicits recruits. Contact C. R. Hamilton, Commanding Officer, 6943 Clinton Rd., Upper Darby. Phone men are invited to contact P.A.M. 3FPC on 1.75 and 3.9 Mc. 6QFJ/5 on Swan Island, Caribbean Sea, is scheduled by 3AGV and 3GRF. 3AGV received his W.A.S. and DX C.C. certificates. The Beacon Radio Amateurs Club is already girding its loins for the Sweepstakes, and vow they will go down fighting (if any). O.B.S. 3HFD asserts that the local gang is showing excellent reserve regarding the European situation.

Traffic: W3ADE 4 3AKB 8 3AQN 27 3BES 3 3BIL 2 3CHH 5 3EML 1851 3FLH 3 3FRY 2 3GDI 32 3GET 23 3GHD 10 3GHH 2 3GKO 247 3HBJ 19 3HCT 3 3HFE 2 3HQE 18 3HRS 293 3HYD 6 3HZK 13 3IAY 27 3QP 365 3RR 96 3ASW 135 3OML 6 3RHE 6 3SNZ 2 3TAH 23 3FLA (WLQA 19).

MARYLAND-DELAWARE-DISTRICT OF COLUMBIA — SCM, Edgar L. Hudson, W3BAK — Acting SCM, E. W. Darne, W3BWT. R.M.'s: 3CQS, 3CXL. Chief R.M.: 3BWT. HGQ will accompany Admiral Byrd on his expedition to the South Pole, and will try to work U. S. A. 14-Mc. hams. EZN has arranged schedule with Byrd Expedition beginning about Dec. 1st. BAK left on Sept. 17th for California; he took along his portable, and will try to work Junior ops. while away. ICT put up new beam antenna, and reports "FB." HUM began operations with the AP trunk line. HMH reports a new rig. FVD, EYX and 8SVV attended the World's Fair and 2USA. The Washington Radio Club chipped in and built a transmitter for HBK, who is bedridden. GUP is a shut-in who would like to receive visitors. EEN has 200 watts on 56 Mc. CZE has new signal squitter. ZD is organizing emergency net, 3790 kc.

Traffic: W3CIZ 548 BWT 503 ICT 31 HUM 23 HMH 8. SOUTHERN NEW JERSEY — SCM, Lester H. Allen, W3CCO — Ass't SCM, Ed. G. Raser, W3ZL. R.M.'s: 3BYR, 3BEI, 3ZI. P.A.M.: 3GNU. In order to maintain the high standard that South Jersey has always stood for, let's not forget teamwork is the leading factor. Why not devote your efforts to help keep South Jersey ahead? We welcome FMR and GNM to the ranks of Official Broadcast Stations. IHD as an Official Observer and HSL as an O.R.S. CCO completed W.A.S. on 'phone. FBM achieved the W.A.S. award on c.w. HWO has new "2½-meter" transceiver. HTJ is building 3-element beam for 28 Mc. BAQ is completing 400-watt 'phone rig. VE has portable rig for emergency use working FB. EUH has new antenna. The Delaware Valley Radio Ass'n had a very unique hook-up between the starters' line and judges' stand at the local Soap Box Derby, giving official timing and announcing contestants. GIZ is back on 28 Mc. FMR was visitor at 2USA and worked several of his Western friends on 14 Mc. QV (Director Martin) and IEV were visitors of the Trenton Radio Society. IIN is new Trenton call. HCL acquired new Breting 9. FNN reports new rig working FB on 28 Mc. AEJ works 1.75-Mc. 'phone when not busy with traffic on 3.5-Mc. c.w. FSI is working out on the Army Amateur Radio System. OQ reports hearing 6PRM on 3.9-Mc. 'phone early in the evening. The Eastern Owl Net got under way for this year under the guidance of GCU. ZI scheduled HVO, his XYL, while at the 1st Army Maneuvers at Fort Ethan Allen, Vt.; also operated "BO-9" Air Corps ground station near Plattsburg. HLV has new e.o.o. EWK has returned to 3.5 Mc. HTP reports working out FB on "2½ meters" using a 27 oscillator and 6L6 modulator. CCC and CFT had swell trip to Cuba with the U.S.N.R. ASQ has returned to 28 Mc. after working 1.75-Mc. 'phone all summer. CFS rebuilt his 1.75-Mc. 'phone rig, now running 150 watts input. FTU has low-power rig on 3.9-Mc. 'phone.

Congratulations to EED on his recent marriage. ERT is back on 1.75-Mc. 'phone. IHO is new call in Salem. KL is located permanently in new QTH. CEU has finally been pushed toward a 'phone rig. Interesting phenomenon: Listening to IDP's 105 watts receiving neck-and-neck reports with FDY's 900 watts on 1.75-Mc. 'phone. Local Pitman Theatre employs 4 hams! GZS, stage manager; IFT, gain grinder; HEO and HRJ in projection room. The Somerset Hills Radio Club banquet was a tremendous success with HOH, MI, FSI, GIZ, and IHD serving on the committee. CCO, the S.C.M. for our Section, and ZI, Army Radio Aide for New Jersey, gave interesting speeches. EBC is working on 14 and 7 Mc. FUI, Secy. of the Tri-County Radio Club, has been quite busy with 56- and 28-Mc. 'phone. Welcome IFT to A.E.C. Supporting Division. Operating an Amateur Radio Station is an interesting booklet published by the League. Those who have not read it may secure a copy free (A.R.R.L. members) from Headquarters or from your S.C.M. Until next month, 73.

Traffic: W3FSI 12 BZX 11 FMR 37 EUH 31 ZI 22 CFS 15 CCO 10 AEJ 9 OQ 6 GCU 5.

WESTERN NEW YORK — SCM, Ed Preston, W3CSE — R.M.'s: 8BJO, 8DSS, 8FCG, 8JTT. P.A.M.: 8CGU. E.C.'s: 8GWY, 8RGA, 8RVM, 8SBV. Section O.R.S. Net frequency: 3720 kc. FCG is now state Radio Aide of the A.A.R.S. BDV and EPM should be fairly accustomed to married life now. EPM keeps going on 28 Mc. BWE blew himself to new RME receiver. ROI is at the Coast Guard Academy, New London, Conn. DSU has a National 1-10 receiver. BCN has parked on 7 Mc. with the new Auburn kilowatt. IWN is putting out nice sock on 1.8-Mc. 'phone. RNG is wrestling with a pole transformer for his new rig. HJN moved out into the sticks, and works 7 Mc. weekdays and 1.8-Mc. 'phone on Sunday. FWU is often heard on 3500.001 kc. SZK has been operating portable for a short time using 3.5-Mc. c.w. and 1.8-Mc. 'phone. He is our latest O.R.S. SMI has "come up" to 3.5 Mc. at last. RBW has new Junior op. 3HZZ, who has been operating portable 8, has returned to Washington. You should see the squitter on CTL's garage MIM. TJK is working c.w. on 1.8 Mc. from Warners. THC of Howlett Hill just southwest of Syracuse is on 1.8-Mc. 'phone. NSL keeps in practice on 1.8-Mc. 'phone. KDY is also on 1.8-Mc. 'phone. SFD has an S9 plus signal on 3745 kc. PLA has returned from his summer home on Conesus Lake to home QTH at Sonyea; with that pair of 211's in the final he is making quite a noise. LJD, PCN and SZK are showing a lot of activity in Buffalo. RKA operates quite a bit around 3600 kc. GZW is seriously considering 1.8- and 28-Mc. 'phone operation. EZ in a statement to the press says the communications experts of the N.C.R. in Syracuse are ready for any emergency. Wonder how SCH, RNE and BRY enjoy living within a few blocks of each other. And JPO doesn't live too far away. SEF is building for increased power. QMR is doing his bit with the A.A.R.S.

Traffic: W3JQE 122 DHU 3 CSE 27 SZK 5.

WESTERN PENNSYLVANIA — SCM, Kendall Speer, Jr., W8OFO — Ass't SCM in charge of Emergency Coordination — W8AVY, NCJ leads with the highest total. With the fall season in full swing now, we should have some nice traffic totals next report. The XYL at NCJ contacted W2USA. The new Zepp antenna at OKS has stepped up signal strength reports. OUT worked KATEF with PP T55's on 28 Mc. running 100 to 200 watts. TSO is on 160 meters 'phone with a nice signal. IRK visited Buffalo. GJM says LDB is back on 1.75-Mc. 'phone. OFO, LBW, QNJ, QBK, JZN completed fifteen days of active duty at sea with the N.C.R. OEM just got married. Congrats. RAT just returned from the Massanutten Military Academy (Woodstock, Va.). His son enters school there. PJJ says RIS has his new three-element Mims Beam installed on a 50-foot tower operating on 28 Mc. RAS is getting fine results with his four-element beam on 28 Mc. DNO is operating on 160 meters. RIT is using the prize HK24 won at SHBP&M Hamfest, with 130 watts. NDE says he is all ready to start schedules again. BOZ says FFX has moved to Youngville. NTJ and SVT are experimenting with 56 Mc. TOJ is in the market for a new receiver. KYW has a new RME70. RFD and RDH of Charleston, W. Va., visited RBM, RAZ and RAU. KXP is figuring on a new "Q" antenna. KWA is starting National Trunk Line and Trunk A the end of September. RBI is operating on 56, 28 and 1.75 Mc. ZAE has been laid up with laryngitis. FQL has been off work for a month with an infected hand.

Traffic: W8NCJ 139 OKS 35 QAN 19 OUT 8 MJK 7 GJM-IOH-OFO 4 DDC-OEM 3 AXD-RAT 2.

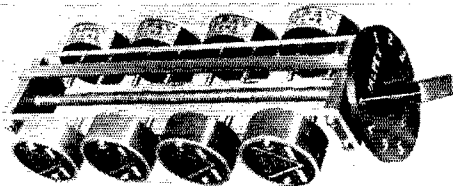

INSTANTLY  
one to eight frequencies with the  
**NEW VALPEY**

Type CS1 crystal selector, from one to eight crystals can be plugged in the same as in a tube socket.

Contact is made one at a time by eight positions numbered on the dial plate.

All eight crystals are ready for immediate use by a turn of the knob on the panel and while not in use are completely cut out of the circuit at the same time away from the danger of rolling off the chassis onto the floor.

Two wires connect the unit to the oscillator circuit, this not only simplifies wiring but reduces losses.

Only three holes need to be drilled for mounting which is easier than mounting one tube socket.

The type CS1 crystal selector is chrome plated brass with polystyrene insulation.

The cost of this unit is less than eight good sockets and a switch.

Net price, less crystals, \$4.95

**THE VALPEY CRYSTALS**

Box 321, Holliston, Mass.

**THIS EXPERT  
WILL HELP YOU  
PASS THE NEW  
RADIO EXAMS**



Newly-written, low-cost, home-study courses under supervision of Arthur R. Nilson, twenty years co-author of technical radio books. Fit yourself for the new license examinations — Radio Telephone Operator 1st or 2nd class and Radio Telegraph Operator's permit, used in the Aeronautical, Forestry and Police services and Broadcasting. Thousands of professional radiomen use Nilson and Hornung textbooks to keep up to date. Now Arthur R. Nilson, will give you direct, detailed lessons, step by step.

SEND FOR FREE 16-PAGE BOOKLET "What The Modern Radioman Must Know." Make this step toward your successful radio career ... now!

**NILSON RADIO SCHOOL**  
51 East 42nd St., New York, N. Y.

Please send me without obligation, your booklet "What The Modern Radioman Must Know."

Name \_\_\_\_\_  
Address \_\_\_\_\_  
City \_\_\_\_\_ State \_\_\_\_\_ Q-11



**A Safety Kw. Transmitter**

(Continued from page 45)

one side of the filter condenser to 6000 volts above ground on modulation peaks, but this is of no consequence with good filter condensers. An underload and overload relay are connected in series with the secondary of the modulation transformer and in the grounded side. Should the final amplifier plate current drop below a predetermined value the underload relay will open the 500-ohm line to the input transformer and stop modulation and possible damage to the output transformer. If the current of the final amplifier exceeds a predetermined value, the overload relay will disengage the primary of the final amplifier plate transformer. An additional relay is used to short-circuit the coil of the underload relay when the modulator filaments are turned off during telegraph operation. Turning off the modulator filaments also automatically shorts the Class-B transformer secondary, and the switching panel is so connected that it is impossible to key the transmitter when the modulator filaments are lighted.

A condenser and resistor network is connected to the secondary of the Class-B transformer to provide a source of audio voltage for a trapezoid pattern on an oscilloscope.

The bias supply is also located on the modulator chassis and is used for the final amplifier only, hence no low resistance bleeder is necessary in order to provide good regulation. In fact, a bleeder of sufficient resistance was used so as to act as a grid leak as well. With no grid current flowing, there is sufficient bias to cut off the final amplifier plate current. When normal grid current is flowing, the voltage across the bias supply bleeder resistance rises to the normal value for Class-C telephone operation. Either this method or a combination of grid leak and well regulated bias supply is recommended for best linearity in a plate-modulated telephone transmitter.

**Power Supply**

The plate transformers for a 1000-watt transmitter are extremely heavy and do not lend themselves to conventional chassis mounting. In this transmitter both the 3000- and 1750-volt transformers are mounted on the base of the relay rack cabinet. Two pairs of 866 rectifiers, two input chokes, and two 4- $\mu$ f. filter condensers are mounted above the plate transformers, comprising the rectifier and filter for both high-voltage power supplies. Only single-section filters have been used, since this was considered sufficient and results in a considerable saving of space. In keeping with government regulations, a 0-4000 volt-meter is used to measure the final amplifier plate voltage at all times. The meter is mounted on the modulator panel. During tuning, the plate voltage to the final amplifier is reduced by taking advantage of the double primary on the 3000-volt transformer, a d.p.d.t. switch connecting the windings either in series or parallel.

The interconnecting cables for the units are neatly formed to fit in the rear corners of the

The logo consists of the letters "QRZ" stacked above "SPEER" in a bold, sans-serif font. The text is contained within a white circle that is part of a larger graphic of overlapping circles and dashed lines.

**S**PEER—calling all stations—to remind them once more that SPEER Graphite Anodes cannot warp, fuse, blow out or soften, and do help keep tubes gas-free by absorbing gases given off by other tube elements.

Why accept less when you can have ALL these advantages simply by using tubes with SPEER Anodes? A list of such tubes and Anode Booklet No. 80 will be mailed promptly on request.



**SPEER CARBON COMPANY**

ST. MARYS, PA. CHICAGO CLEVELAND DETROIT MILWAUKEE NEW YORK PITTSBURGH

9458

quality above all  
**SOLAR**  
**TRANSMITTING CAPACITORS**

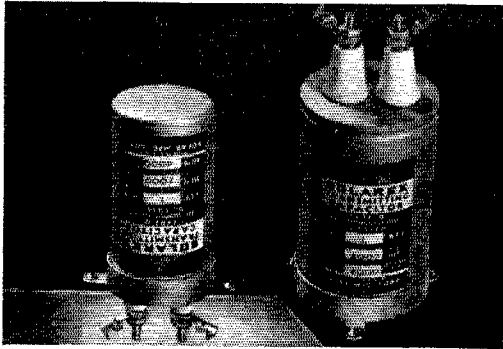

**SOLAREX** — Super-value for filters, the ideal type for advanced amateurs, insuring utmost service and economy.

Write for Catalog No. 10

**SOLAR MFG. CORP.**  
 Bayonne, New Jersey

**RADIO COURSES**

New Classes Now Starting

- RADIO OPERATING • BROADCASTING • CODE
- RADIO SERVICING • TELEVISION
- ELECTRONICS — 1 year day course; 2 years eve.
- Day and Evening Classes — Booklet upon request

**NEW YORK YMCA SCHOOLS**  
 4 West 63rd Street, New York City

**PRECISION CRYSTALS**

Highest quality crystals carefully prepared for frequency stability and maximum output. Rigidly tested to assure you of dependable operation. Be sure of your transmitter frequency — use **PRECISION CRYSTALS**.

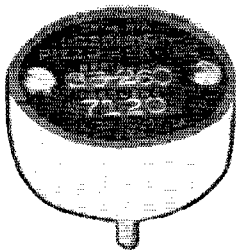

Type 4-A low drift unit plugs into a tube socket. The holder body is of white ceremite. Frequency drift of unit 4 cycles or less per million per degree centigrade. Supplied within 5 Kc. of your specified frequency in the 40, 80 or 160 meter bands. Calibration accurate to within 0.03%. Price, \$4.00.

'X' cut crystals in type 4 holder for tube socket supplied within 5 Kc. of your specified frequency in the 40, 80 or 160 meter bands. Price, \$3.50.

Either the low drift crystals or the 'X' cut can be supplied in square holders to plug into G.R. type jacks at the above prices.

Crystals for commercial requirements quoted on at your request. Now in our tenth year of business.

**PRECISION PIEZO SERVICE**  
 427 Asia Street Baton Rouge, La.

cabinet and laced tightly with armature twine. The cables can best be made on a work bench by laying out a scale drawing of the rear view of the transmitter on wrapping paper. Nails can be driven to form a temporary channel to lay wires in and to form the bends for the various branches of the cable. All chassis are connected together by a half-inch copper strip running along the side to furnish a common ground. Three-quarter-inch diameter holes were drilled in each rear corner of the bottom of the cabinet for the cabling for remote control connections. An eight-contact plug is mounted on the left side in the rear of the base and handles the 500-ohm line, key, plate-primary relay, audio voltage for the oscilloscope, and ground. Next to this is mounted an Amphenol 92-C receptacle for the 110-volt a.c. Alongside the power receptacle is a four-prong socket which is connected to the switch panel so as to provide a green signal light on the operating desk when filaments are on and a red light when the carrier is on. On the right side of the rear of the base are mounted three Amphenol type PC1M connectors which handle the external e.c.o. voltage, the r.f. from the final amplifier tank circuit for the oscilloscope, and the receiving antenna connection from the change-over relay. Amphenol small size flexible co-axial cable, No. 76-22S, was used for all interconnecting links carrying r.f.

**Strays**

If your Class-B output transformer doesn't come equipped with a safety gap, the attachment of such a gap across the secondary output terminals may save the transformer in case the Class-C load is lost. The gap should be adjusted so that no arc occurs during normal modulation or slight overmodulation.

— W6LNS

Ceramic coil forms may be drilled in a drill press with a short piece of copper tubing of the right diameter in the chuck. Use valve-grinding compound and lots of water on the edge of the tubing, never allowing the water to become hot.

— W2ALP

**High-Efficiency Grid-Modulated Amplifiers**

(Continued from page 37)

normal plate voltage, and the plate current noted. The phasing coil is then reconnected, with tube No. 2 filament still open, the resistor across tank No. 1 removed, and the resistance  $R/2$  placed across tank No. 2. On retuning the network the plate current should be the same as before, if the size of the phasing coil is correct. If, under these conditions, tube No. 1 draws too much plate current the phasing coil has insufficient inductance and if the plate current is too low the phasing coil has too much inductance. In general, the calculated value will be very close to the correct

# The RADIO SHACK

See the  
**THORDARSON**

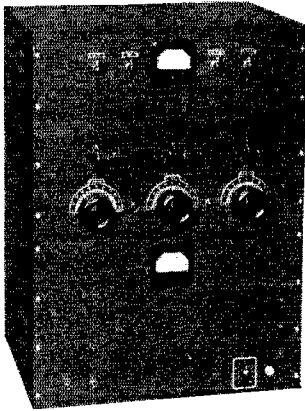

## 100 WATT MULTI-BAND TRANSMITTER

COMPLETE TRANSMITTER  
AND MODULATOR

Includes all Thordarson parts and foundation units, and all other component parts, tubes, cabinet and crystals with coils for any three bands.

**CASH NET PRICE \$165.03**

\$33.00 down and \$11.86 a month for twelve months

## HAMMARLUND HQ-120

- ★ Variable crystal filter
- ★ Regulated power supply
- ★ Calibrated band spread

**CASH PRICE \$129.00**

**LIBERAL TIME PAYMENT PLAN**  
\$24.00 down and \$9.47 per month  
for twelve months

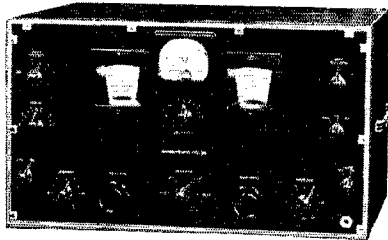

### Kit of Parts for the QST Regenerative Single-Signal Super

*Described in October '38 QST by George Grammer*

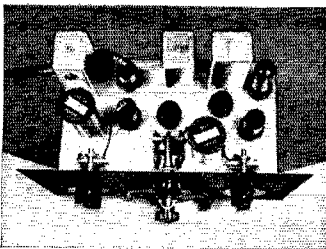

All parts as specified and of nationally advertised manufacturers.

Complete kit less tubes and power supply. NET PRICE..... **\$19.56**

Kit of 6 Raytheon tubes for above kit. NET PRICE..... **\$3.95**

Crackle finish hinged top cabinet supplied at \$1.57 extra

CABLE ADDRESS: RADSHACK

### Sensational Value TRANSMITTING CONDENSER



Cap. Mds.	Working Volts	Net Price
2	1000	\$ .95

### X-CUT 40-METER MOUNTED CRYSTAL

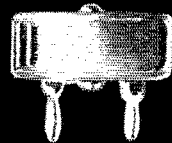

7000 to 7200 KC  
Supplied within 10 KC of your  
desired frequency.  
**Special Net Price \$1.95**

**UNMOUNTED CRYSTALS**  
7000 KC TO 7300 KC  
Within 10 KC of your desired  
frequency.  
**Special Low Price \$1.35**

BUY ON  
EASY TERMS

MAIL ORDERS  
PROMPTLY FILLED

Write for FREE  
100-page CATALOG

# The RADIO SHACK

167 WASHINGTON ST., BOSTON, MASS., U.S.A.

# NEW TURNER DYNAMIC 33D

## Microphone

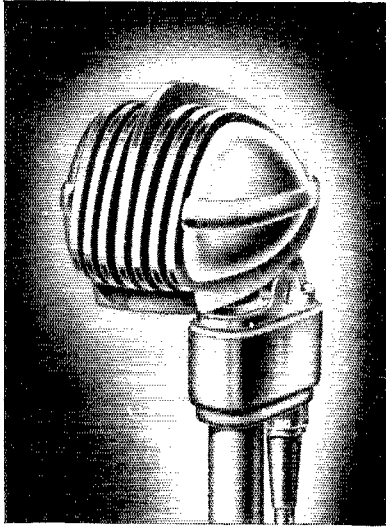

●  
Removable  
Cable Set

●  
Full Tilting  
Head

●  
Trouble-Free  
Operating  
for Hams,  
Recorder or  
P.A. Work

Balanced line cable eliminates noise pick-up. Level -54DB. Range 40-9000 cycles. Won't blast. Not affected by climate. A handsome, rugged unit that adds class to your equipment at low cost.

Available in all  
impedances.

**\$23.50** List

with 7-ft. Cable Set

Get Full Details

**The TURNER CO.**

904 17th Street N.E.  
CEDAR RAPIDS, IOWA

## AMATEUR RADIO LICENSES

Day and Evening Classes in Code and Theory  
**HOME STUDY COURSES**

*Reasonable, Efficient and Thorough, Hundreds of  
Licensed Students Now on the Air*

American Radio Institute, 1123 Broadway, New York, N. Y.

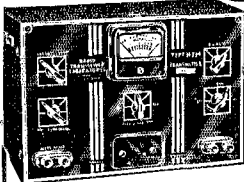

**MAXIMUM  
EFFICIENCY**  
at all times with  
**TYPE "HFM"**  
Portable Xmitter

- Six Bands 1715 — 60,000 K.C. on two crystals
- All Frequencies Crystal Controlled
- Instantly Changeable Mobile or Portable
- Final Tube Input 21 to 36 Watts.

Net to Amateurs..... **\$57.60**

*Write for bulletins listing our complete,  
new and approved line for amateurs.*

**RADIO TRANSCIVER LABORATORIES**

8627 115 Street . Richmond Hill, New York City  
CABLE ADDRESS: "RATRLAB"

# RADIO

**ENGINEERING**, broadcasting, aviation and police radio, servicing, marine radio telegraphy and telephony, Morse telegraphy and railway accounting taught thoroughly. 48 weeks' engineering course, equivalent to three years of college radio work. School established 1874. All expenses low. Catalog free.  
**DODGE'S INSTITUTE, Day Street, Valparaiso, Indiana**

110

value and in most instances will not require much adjustment. Finally, the filament of tube No. 2 is closed and voltages applied (tube No. 2 is biased approximately to cut-off so takes negligible plate current). Then the load on tank No. 2 is adjusted to bring the plate current on tube No. 1 to the same value as before.

The network of Fig. 1-B is inserted in the grid circuit of tube No. 1 to advance the phase 90 degrees so that the r.f. currents from the two tubes will be additive in tank No. 2. This network, in comparison, is not very critical. The series condenser is chosen so that its capacitive reactance will have a value approximately equal to the grid input impedance. Tank No. 1 of the grid network is tuned to resonance and tank No. 2, with the network loosely coupled to the driver, adjusted for maximum plate current on the driver. This adjustment should correspond to minimum plate current on No. 2 tube and maximum grid current on tube No. 1. Maximum loading on the driver results because as proper adjustment is reached the effective inductance of tank No. 2 is series resonant with the series condenser  $C_0$ , and so effectively lowers the load impedance on the driver.

Final adjustment of the grid phasing network should not be made until both tubes have been neutralized. Neutralization may be accomplished using the conventional methods.

It might be wise to point out that tank No. 1 of the grid phasing network may be used either as the tank circuit of the driver stage or as a separate tank, link-coupled to the driver. In this latter case, however, maximum loading on the driver as tank No. 2 is varied may not necessarily hold because of reflected reactance into tank No. 1 from the link. In this case the more certain indication of correct adjustment is that of tuning tank No. 2 for minimum plate current on tube No. 2.

Driving power required is about the same as that for a conventional Class-C amplifier. Considering losses in the various tank circuits, the driver output required will be about four or five times the rated driving power for one tube.

Fig. 3 shows the diagram of a transmitter built shortly after the appearance of the paper by Terman and Woodyard. Fairly good results were obtained with it; the quality was good, and an output of 50 watts from the two 807 tubes was reached. The output was measured by using a Weston 0-500-ma. r.f. meter and an Ohmite dummy antenna.

The adjustment of excitation and bias was more critical than was desired and it would appear that it would be easier to make this adjustment on triodes than on pentodes.

It was difficult to obtain non-inductive resistors to use in the adjustment of the plate phasing network as suggested by Terman and Woodyard. Final adjustment was reached by changing the coupling to tank No. 2 and trying several different values of inductance for the phasing coil for correct plate current on tube No. 1. If correct plate current did not result a new value of coupling was chosen and the testing repeated. It is possible to get the wrong value of coupling and





**THIS IS AN ACTUAL PHOTO TAKEN ON MY SHIPPING TABLE OF SOME OF THE MODELS ALWAYS IN STOCK**

•  
Write me fully about type of receiver you want. I will help you get the right receiver and will see that you are 100% satisfied. We stock all receivers — more than 25 models of all makes — and know all about them. Ask for technical information about any receivers.

•  
YOU can buy on 6% terms financed by myself so you buy with less cost — more convenience — quicker delivery.

•  
YOU get maximum trade-in for your receiver — describe it and I will tell you its trade-in value — and can pay the balance on my 6% terms.

•  
YOU get ten days' free trial — you don't buy unless you are satisfied.

•  
YOU get prompt shipment from the world's most complete stock of amateur receivers. Shipment from factory if you wish.

•  
So write to me for any receivers, transmitters, kits, antennas, parts, etc. Your inquiries and orders invited.

*Bob Henry*  
**W9ARA**

# HENRY RADIO SHOP

BUTLER, MISSOURI



# SPOT

## for NOVEMBER

### FILAMENT TRANSFORMERS

Bracket Mounting  
Standard Construction  
Fully Guaranteed

**2 1/2 Volts 10 Amps**  
**10,000 Volts insulation**

# 70c

**6.3 Volts 6 Amps**  
**2500 Volts insulation**

# 85c

These transformers bear the same warranty as when formerly sold at full price.

### BLILEY CRYSTALS

New LOW PRICE on VF-1 Variable Frequency, Low Drift crystals. Your choice of frequency in 40 or 80 meter bands. **\$6.60**

Bliley Harmonic Chart in colors on heavy cardboard. Suitable for mounting.

*Free for the asking.*

### General Rotary ANTENNA ELEMENTS are selling like WILD-FIRE

Construct your own Rotary Beam at small cost.

General elements are constructed of light, durable seamless tubular steel — both copper and cadmium plated. Due to unusual construction — they mount with practically no sag.

JT-10 for 10 meters, length 8' 7" ..... **\$1.62**  
JT-20 for 20 meters, length 17' 6" ..... **2.99**

### HETROFIL DUAL CONTROLS

I.R.C. type JS-1114 ..... **\$1.47**

Consists of tandem 10,000 ohm controls with proper taper and 12 degrees lag in coupling to allow for precise and quick setting.

### SWAP IN YOUR RECEIVER FOR A NEW MODEL

and pay the difference on convenient terms at Sun.

Sun allows highest trade-in on your old receiver.

Stop in at Sun (or write in), see all the latest communications receivers in operation and let us quote you our amazingly liberal prices.

HAMMARLUND — HALLICRAFTERS — RME — NATIONAL — HOWARD — GUTHMAN

### JAMES MILLEN Products at SUN

You can now obtain the new Jim Millen products at Sun. Ask for a copy of the Millen catalogue — and examine their desirable accessories.

Millen Hetrofil, Complete ..... **\$3.50**

### MORE NEW SUN FIRSTS

B & W Baby Switching Turret—5 band low power switching; Taylor TW-150 Tubes—Thin Wall Carbon Tubes; Guthman U-35 Keytuner—Learn code rapidly—Meissner Television Components—Special television chokes and coils—Hytron GTX Ceramic base receiving tubes.

Catalogues on any of above will be gladly supplied

☆ EXPORT ORDERS SOLICITED

☆ MAIL ORDERS PROMPTLY FILLED



# RADIO CO.

212 Fulton Street, Dept. UT New York

Cable Address: SUNRADIO NEW YORK

still have the correct plate current on tube No. 1 if the size of the phasing coil is far off, but this will be indicated by the reluctance of tube No. 2 to increase its plate current with modulation, as it would be if its load impedance was too high.

It was very difficult to get enough coupling to tank No. 2 so that it would present the proper terminating impedance for the network. The desired value was about 675 ohms. The  $L/C$  ratio was about 320,000 so the coupled resistance necessary was about 475 ohms.

The second transmitter, shown in Fig. 4, uses HF-100's. Split tank circuits were used here to provide easy neutralization. The  $L/C$  ratio in this case was about 330,000 and the coupled resistance needed is only about 78.5 ohms. The inductance of the plate phasing coil is 24 microhenrys and has a reactance of 2100 ohms.

D.c. bias on tube No. 1 is all grid leak bias — a bias resistor of 10,000 ohms and a grid current of 20 ma. provide a bias of 200 volts. Bias on tube No. 2 is all fixed bias and is supplied by a small bias rectifier capable of delivering 300 volts.

Power output from this transmitter is 200 watts, and the general results obtained with it have been very satisfactory.

Shunt feed was used in this transmitter to reduce the danger to the operator which might be present if d.c. plate voltage appeared on the tank coils and the phasing coil.

With this type of amplifier it is interesting to note that as the antenna coupling is increased the plate current of tube No. 1 decreases. This is in complete accord with the theory of the network but presents a somewhat different view than that to which we are accustomed. Conversely, as coupling is decreased the plate current of tube No. 1 will increase and with no coupling may become dangerously high.

Linearity, during modulation, is dependent to a considerable extent upon the relation between the applied audio voltages, bias and excitation and can best be determined by experimentation. An oscilloscope will be helpful. In general, tube No. 2 requires one-half to three-quarters the modulating voltage applied to tube No. 1. Excitation is about the same on both tubes, with tube No. 2 biased so that it will draw essentially no plate current at carrier level.

By installing audio chokes in the grid leads, the audio requirements were lowered considerably as compared to the method shown in Fig. 4, because without them the modulator is terminated by the bias resistor as well as the internal grid impedance of the tube. An alternative arrangement would be to feed the audio voltage in series with the bias, with the grid leak and bias supply by-passed for audio frequencies. This would necessitate placing both sides of the fixed bias supply above ground for audio frequencies, unless separate secondaries are available on the a.f. output transformer.

The author wishes to express his appreciation of the help and encouragement given him by Mark W. Bullock, Technical Supervisor for the Central States Broadcasting Company, and by Burt E. Davis, W9UZE.

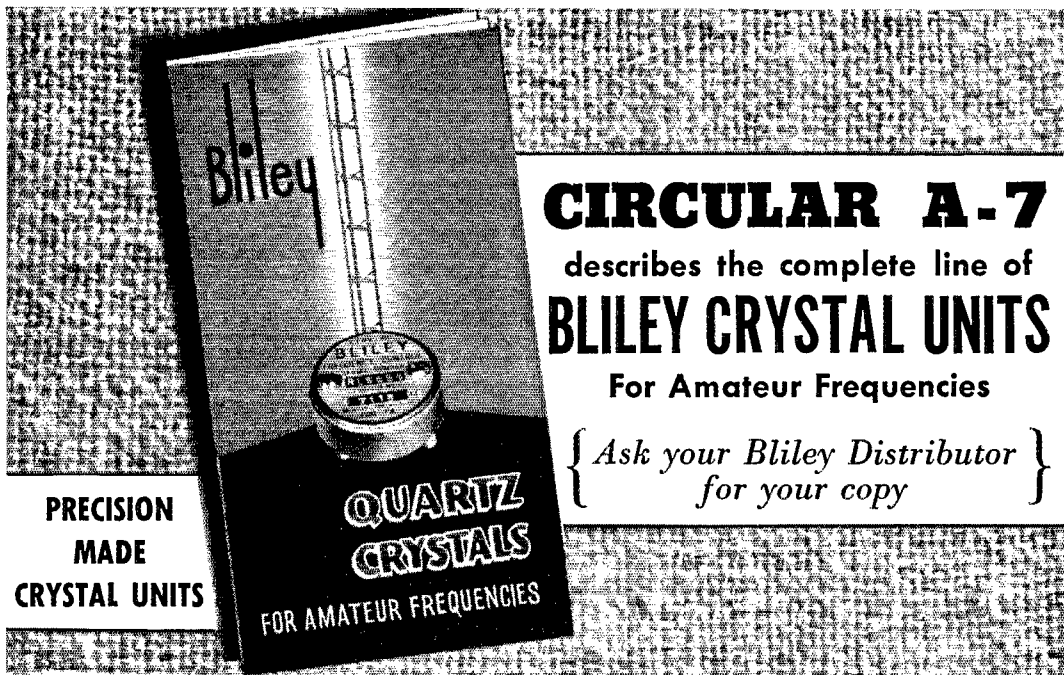

**PRECISION  
MADE  
CRYSTAL UNITS**

# **CIRCULAR A-7** describes the complete line of **BLILEY CRYSTAL UNITS**

**For Amateur Frequencies**

{ *Ask your Bliley Distributor  
for your copy* }

# **BLILEY CRYSTAL UNITS**

## **Premax Units for All Parasitic Arrays**

*Reflectors, Directors, Combination Arrays—Horizontal,  
Vertical or Beam!*

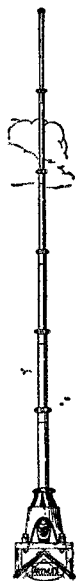

As you study the arrays in the new A.R.R.L. Antenna Book, you should have Premax Technical Bulletin H-3 at hand for reference. This bulletin illustrates over thirty arrays and hookups which are in successful use.

Premax Adjustable Telescoping Corulite Units (illustrated at the right) are available for one, two, three and four or more element arrays — strong, light-weight steel units in single or double-end style.

Premax Vertical Radiators and Masts in Steel, Monel or Aluminum — fully telescoping and adjustable from 6 to 35 feet — for your vertical arrays.

**See them at your Jobbers**

**SEND FOR THESE FREE BULLETINS:** Technical Bulletin H-3 for erecting and feeding diagrams — Bulletin HR for Elements, Verticals, Rotomounts, Towers, Insulators and Accessories.

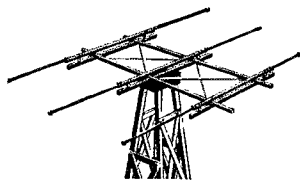

Premax Wood Frames for Rotary Beams — Wood Towers — and practical Rotomounts are the answer to support, construction and rotating problems.

**Premax Products**  
Division of Chisholm-Ryder Co., Inc.  
4020 Highland Ave., Niagara Falls, N. Y.

## FOR YOUR TOOL KIT

This SIGNAL  
1/4 inch  
DRILL

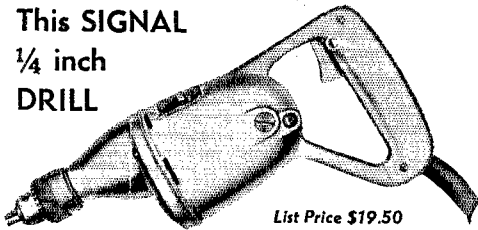

List Price \$19.50

### IS TOPS IN VALUE

This is the drill to buy for your tool kit. It is the same drill used by electricians, radio repairmen, and shops. Capacity 1/4" in steel, 1/2" in hard-wood, measures 12" long; speed 2950 R.P.M., trigger switch, 8-foot rubber cord and plug, weight 5 1/2 pounds. SIGNAL drills are dependable because they're well made, and they are outstanding values because they're priced right. If your radio jobber cannot supply you, write us.

SIGNAL ELECTRIC MFG. CO., Menominee, Mich.

Established  
1892

**SIGNAL**

## ARMY, NAVY OR COMMERCIAL RADIO COMMUNICATIONS OFFER INTERESTING CAREER!

Begin now to prepare yourself through Candler System Training, even if you know nothing of code or radio fundamentals. Or if you know code but copy "letter-for-letter" and send jerkily, Candler High-Speed training will soon have you reading code as easily as you read print and copying behind at high speeds.

You may be practicing wrong — following old fashioned methods that are slow and hard. Why not send today for

### Candler's New BOOK OF FACTS?

It gives you many helpful tips and points the way to success as an amateur or commercial operator. In the light of his 28 years' experience in training operators in the Army, Navy, Commercial and Amateur Communications, Walter Candler will be glad to give you expert advice which does not obligate you. Write him today. You will receive a personal reply and the Book of Facts, free.

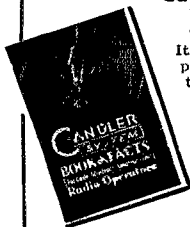

**CANDLER SYSTEM CO.**

Dept. Q-11 ASHEVILLE, N. C., U. S. A.

## Hamfesters Picnic

THE Hamfesters Radio Club's sixth annual picnic and hamfest, held August 27th at Frankfort Grove, near Chicago, was one of hamdom's largest gatherings, with over 2900 paid adult admissions. An additional unnumbered group crashed the gate when the state highway police ordered several hundred cars parked on the highway admitted free in order that traffic could be resumed.

Notable among the varied equipment exhibits were emergency units of the Army and Navy, set up for operation, and the W9VVSX field day and A.E.C. groups. Three transmitters were on the air, besides numerous private portable-mobile car installations. The energetic enjoyed the various games, races and the c.w.-phone baseball fracas, with the c.w. men winning for the first time in three years. The lazy ones ragchewed, visited the new B.C. transmitters of WLS-WENR, played horseshoes and watched the twelve act stage show.

Sue King, W2LXS, came the greatest distance of those registering. Opal Sisk, W9CMV, at 104 pounds proved to be the lightest amateur present, while 324 pounds earned Al Knodell, W9TLQ, the title of the heaviest ham. George Fenton, W9SXZ, successfully retained his crown as champion blueberry pie eater.

The refreshment stand had prepared for 2500 people, but the hungry mob consumed over 200 pounds of meat, 2400 buns, 100 cases of pop, 25 gallons of ice cream, etc., and by nightfall food was at a premium, even cafés in nearby towns having a sellout. Dancing in the evening continued until nearly midnight, when QSB fell on the last strains of Auld Lang Syne, and a very tired committee started planning a bigger and better picnic and hamfest for 1940. — J. H.

Here It Is! The "CHAMPION"  
Genuine **VIBROPLEX**

only \$9.95

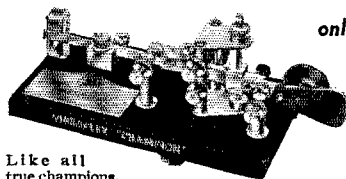

Like all true champions, the new Vibroplex "CHAMPION" defies competition. As efficient in performance as it is handsome in design, the "CHAMPION" is our answer to the demand for a BUG of established quality, proved sending ability and assured ease of operation. And in addition to these outstanding sending features, this new BUG is priced so low no one need be without it. Designed primarily for the amateur, professional operators will find it amply qualified to give an expert account of itself anywhere.

See your dealer today. If he cannot supply you, write or order direct from

**THE VIBROPLEX CO., Inc.**

832 Broadway

New York, N. Y.

An exceptional key having exceptional sending qualities. Chrome plated. Black crackle standard size base. Standard size contact points same as more expensive models. Furnished without circuit closer, cord and wedge.



The BUG trademark identifies the Genuine Vibroplex

## WITH REMOVABLE STAND-OFF INSULATORS

■ For convenience in mounting on the chassis, the new models of the NC-600U neutralizing condenser and the R-100U and R-300U Chokes are now provided with a small stand-off insulator for chassis mounting. For "pigtail mounting," the insulator may be unscrewed and used for other purposes. Chokes without the insulator are still available, but at a new low price.

Type NC-600U Neutralizing Condenser,  
with insulator. List Price . . . . . **\$5.55**

Type R-100U Choke, with insulator.  
List Price . . . . . **\$6.60**

Type R-300U Choke, with insulator.  
List Price . . . . . **\$6.60**

**NATIONAL COMPANY, INC.**  
Malden, Massachusetts

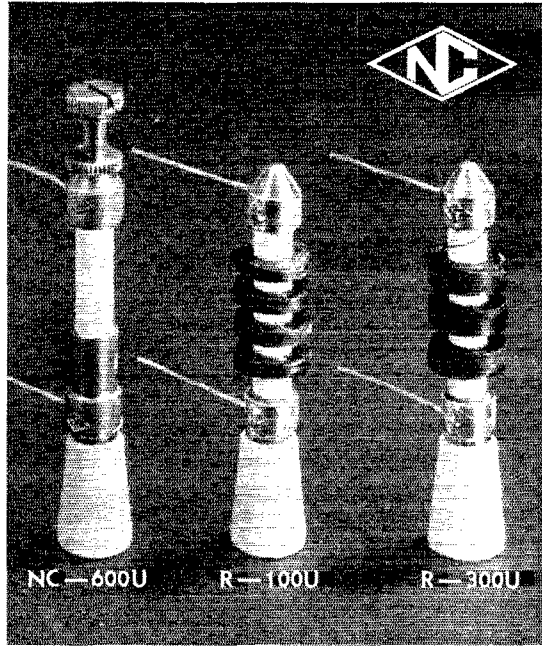

## Here's accuracy at a price you like to pay RCP Test Equipment

RCP offers accuracy and dependability at low cost. There is no comparison with other instruments on the market — because RCP Test Equipment is the *only* line meeting ham requirements at such low prices. With RCP you get precision instruments at surprisingly modest cost. Have you discovered RCP Test Equipment? Check the models below for unusual features and prices.

### RCP Trouble Shooter Model 432



Multi scale D'Arsonval meter 1 mil, accurate within 2%. Individual ohm scale as on expensive instruments. DC volts 0-5/0-50/0-500/0-1000 at 1000 ohm per volt sensitivity. DC milliamperes 0-1/0-10. Ohms 0-500/0-50,000/0-500,000. Self contained batteries for all ohmmeter ranges. Low range has each of first five divisions reading as low as 0.2 ohm. Net . . . . . **\$5.95**

### RCP Pocket Multitester Model 413



IT TOOK RCP to design a pocket size instrument with the sensitivity, ranges and features of the large expensive testers. Think of the space and the money you save! Sensitivity: 400 microamps, or 2500 ohms per volt. Fine Alnico magnet identical to that used in ultra sensitive, high cost meters. AC volts, 0/10/50/250/1000/5000; DC volts, 0/10/50/250/1000/5000. Ohms, 0/500/100,000/1,000,000. DC Microamps, 0/400; DC Milliamps, 0/10/100/1000; DC Amps, 0/10. In attractive natural finish wood case. Net **\$12.90**

### Model 660

### RCP Electronic Multitester

Wide range and high sensitivity in this new vacuum tube volt-ohmmeter. Ranges up to 6000 volts and 1 billion ohms. Lowest voltage reading 0.1 volt. Gets its sensitivity from input resistance of 200 megohms on all ranges except 6 volts. Total of 12 ranges all on direct reading scales. Extreme operating simplicity as well as versatility makes this instrument ideal for ultra sensitive and high range applications. Supplied in sloping walnut case. Net . . . . . **\$18.85**

See your jobber today,  
or write direct for  
Catalog No. 121 on  
the complete RCP line.

**RADIO CITY** Products Co. INC  
88 PARK PLACE NEW YORK CITY

# Popular Items . . . at Popular Prices

## BROWNING

### Visual Frequency Monitor

With the visual and aural zero beat indicator checks against WWV. Accuracy greater than 2 parts in 10,000. Complete band spread, direct reading. Also may be used as a signal generator to check receiver calibration and check frequency of incoming signals. Net. **\$27.45**

## RME "LF 90"

### Low Frequency Expander

May be used with any receiver for reception of 90 to 608 k.c. by tuning receiver to 1550 k.c.—self-contained—operates on 110 volts, a.c. Net. **\$19.50**

## BLILEY "VF 1" 40 or 80 METER

### Variable Frequency Crystals

NOW ONLY \$6.60

## The "HETROFIL" Audio Filter

Increases the selectivity of any receiver. Rejects and suppresses interfering signals or audio beat notes. See September 1939 issue of *QST* for complete technical description. Net **\$3.50**

## JAMES MILLEN PRODUCTS

In Stock

## POLYSTYRENE

The finest insulation for H.F. use. Available in sheets, coil forms, strips, ribbon and cement.

### ALL STRIPS ARE 12" IN LENGTH

Size	Net Price	Size	Net Price	Size	Net Price
1-16" x 1-4"	\$.15	1-8" x 1-4"	\$.22	3-16" x 1-4"	\$.34
1-16" x 1-2"	.20	1-8" x 1-2"	.34	3-16" x 1-2"	.50
1-16" x 3-4"	.25	1-8" x 3-4"	.42	3-16" x 3-4"	.61
1-16" x 1"	.31	1-8" x 1"	.53	3-16" x 1"	.80
1-4" x 1-4"	.43	3-8" x 1-4"	.63	1-2" x 1-4"	.80
1-4" x 1-2"	.64				
1-4" x 3-4"	.80				

Polystyrene 5 pound plug in coil forms. Diameter 1 1/4". Length of body 2 1/4". Net. **59c**

## New CARDWELL 100 WATT

### High Efficiency Tank Foundation Kit

Complete with neutralizing condensers, split-stator tank condenser and bracket for mounting B & W coil. Net. **\$7.99**

Write for new CARDWELL catalog

## New HAMMARLUND Star

2 1/4 m.h., 125 m.a., chokes 1 mmf. Distributed capacity. Only **15c**

OUR *Best* VALUE IS OUR RECORD OF LOYAL SERVICE

# HARVEY

Radio Company of New York

103 WEST 43rd STREET • NEW YORK, N. Y.

CABLE ADDRESS: "HARADIO"

## ★ A.R.R.L. QSL BUREAU ★

For the convenience of its members, the League maintains a QSL-card forwarding system which operates through volunteer "District QSL Managers" in each of the nine United States and five Canadian districts. In order to secure such foreign cards as may be received for you, send your district manager a standard No. 10 stamped envelope. If you have reason to expect a considerable number of cards, put on an extra stamp so that it has a total of six-cents postage. Your own name and address go in the customary place on the face, and *your station call should be printed prominently in the upper left-hand corner.*

W1 — J. T. Steiger, W1BGY, 35 Call Street, Willimansett, Mass.

W2 — H. W. Yahnel, W2SN, Lake Ave., Helmetta, N. J.

W3 — Maurice Downs, W3WU, 1311 Sheridan St., N. W., Washington, D. C.

W4 — G. W. Hoke, W4DYB, 328 Mell Ave., N. E., Atlanta, Ga.

W5 — E. H. Treadaway, W5DKR, 2749 Myrtle St., New Orleans, La.

W6 — Horace Greer, W6TI, 414 Fairmount Ave., Oakland, Calif.

W7 — Frank E. Pratt, W7DXZ, 5023 So. Ferry St., Tacoma, Wash.

W8 — F. W. Allen, W8GER, 324 Richmond Ave., Dayton, Ohio.

W9 — Alva A. Smith, W9DMA, 238 East Main St., Caledonia, Minn.

VE1 — L. J. Fader, VE1FQ, 125 Henry St., Halifax, N. S.

VE2 — C. W. Skarstedt, VE2DR, 236 Elm Ave., Westmount, P. Q.

VE3 — Bert Knowles, VE3QB, Lanark, Ont.

VE4 — George Behrends, VE4RO, 186 Oakdean Blvd., St. James, Winnipeg, Manitoba.

VE5 — H. R. Hough, VE5HR, 1785 First St., Victoria, B. C.

K4 — F. McCown, K4RJ, Family Court 7, San-turce, Puerto Rico.

K5 — Norman F. Miller, K5AF, 15th Air Base Squadron, Albrook Field, Canal Zone.

K6 — James F. Pa., K6LBH, 1416D Lunalilo St., Honolulu, T. H.

K7 — Jerry McKinley, K7GSC, Box 1533, Juneau, Alaska.

KA — George L. Rickard, KA1GR, P. O. Box 849, Manila, P. I.

## Effective Antennas

(Continued from page 16)

ments, in place of the double supports for the 14-Mc. elements. The latter is made possible because of the lighter weight of the elements. Also, the smaller size Johnson insulators, type 66, may be used throughout.

Halving the 14-Mc. dimensions when we double the frequency will do quite nicely, and from that we find that a total overall length, for the longest

# New Model Dynamic Microphone

In presenting this new Model "DN" Dynamic Microphone, Astatic Engineers give to amateur and other fields of usage, an instrument of exceptional dependability, high in efficiency, sturdy in construction and low in cost.

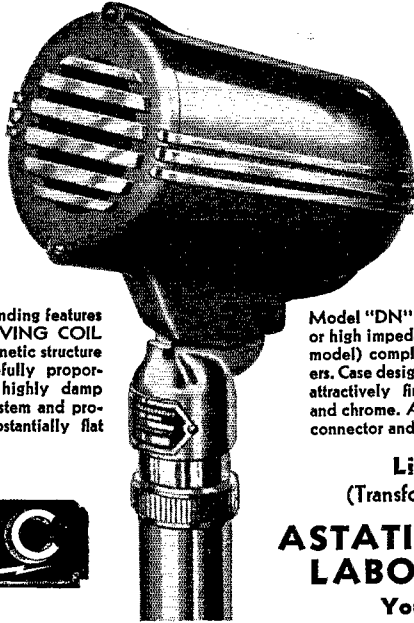

Equipped with Astatic's unique swivel mount, tilting head, the pick-up pattern may be made semi-directional in the horizontal position or non-directional in the vertical position, as desired.

Incorporated among its many outstanding features is Astatic's new UNITARY MOVING COIL SYSTEM, a correctly designed magnetic structure with ALNICO Magnet and carefully proportioned ACOUSTIC CIRCUIT to highly damp natural resonance of the moving system and provide a response characteristic substantially flat from 50 to 7,000 cycles.

Model "DN" is available in 50, 200 and 500 ohms or high impedance models, all (except the 50 ohm model) complete with internal matching transformers. Case design distinctively new and good looking, attractively finished in two-tone opalescent-gray and chrome. All "DN" models equipped with plug connector and 25-ft. cable.



List Price, \$20.00  
(Transformer Models \$22.50)

**ASTATIC MICROPHONE  
LABORATORY, Inc.**  
Youngstown, Ohio

## LEARN RADIO • TELEVISION

60-page catalog on request. Oldest, largest and best equipped in New England. Write for new catalog.

**MASS. RADIO SCHOOL**

18 Boylston Street

Boston, Mass.

## RADIO ENGINEERING



RCA Institutes offer an intensive course of high standard embracing all phases of Radio and Television. Practical training with modern equipment at New York and Chicago schools. Also specialized courses and Home Study Courses under "No obligation" plan.

Illustrated Catalog on request

**RCA INSTITUTES, INC.** Dept. ST-39

A Radio Corporation of America Service

75 Varick St., New York

1154 Merchandise Mart, Chicago

## NEW XT

# DYNAMOTORS

5200 SERIES... OUTPUT 200 WATTS

6100 SERIES... OUTPUT 500 WATTS

Write for Information Today

**EICOR INC.** 513 S. Laflin Street  
Chicago, Ill., U.S.A.

## A GOOD NAME GOES A LONG WAY

The good name of Ken-Rad Radio Tubes is due to the highest standards of quality in manufacture and performance.



# Ken-Rad Radio Tubes

**KEN-RAD TUBE & LAMP CORPORATION - OWENSBORO, KY.**

Manufacturers of all types of radio tubes and Ken-Rad Electric Lamp Bulbs

## Gross Transmitters for Dependability and Economy

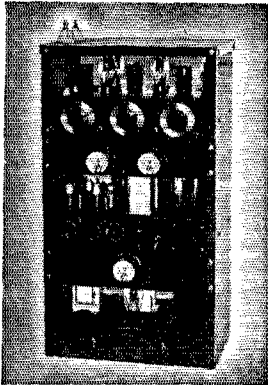

★ Write for free descriptive bulletin on our CB-150 and CB-250 Radiophone Transmitters

← Special price  
For limited time, minus tubes and accessories.

**\$110.50**

on the

### GROSS CB-55 RADIOPHONE TRANSMITTER

FB. for 30 MC.—Input: 95 watts. Uses: 2-T20 tubes in R.F. and 6L6's in modulator. Coils available for 30, 14, 7, 3.5, and 1.7 mc. Descriptive bulletin on request.

**GROSS RADIO, Inc.**

51 Vesey Street New York  
Cable Address: GROSSINC

### 110 VOLTS AC Katlight Plants

Have special plant for operating radio receivers and transmitters. Close voltage regulation. Full 850 watts AC and 100 watts at 6 volts. Filtered and Shielded.

Amateur's price—JRA8, 350 watt \$66.00  
Amateur's price—JRB6, 550 watt 97.50

Other sizes up to 10,000 watts.  
Both gasoline and Diesel.

KATLIGHT, Mankato, Minn., U.S.A.



## LEARN TO SEND AND RECEIVE CODE

Learn to send and receive code signals, like operators on ships at sea and at commercial and amateur land stations. Intercept distress signals, news flashes, bulletins, and dozens of other kinds of interesting radio communications.

MASTER TELEPLEX teaches you to receive code exactly the way the world's best operators do—by sound. A heavy waxed paper tape, running through a machine, operates an automatic key which sends messages to you, at any speed you desire. As you improve in speed, the machine sends faster, gradually preparing you for top-speed amateur and commercial signals. With the new All Electric MASTER TELEPLEX you learn to send by sending and the signals you send are repeated back to you, exactly as you sent them, thus enabling you to correct your own errors. We furnish a complete course, lend you the improved All Electric MASTER TELEPLEX and give you personal instruction with a MONEY BACK GUARANTEE. Send for our new TELEPLEX FOLDER Q11 today. IT'S FREE.

**"HAM" SPECIAL TELEPLEX CO., 67-68 Park Place, N. Y.**

Standard Teleplex—a highly efficient code teacher using heavy specially prepared waxed paper tape, having two rows of perforations. Write for Free folder "Q.T.11"

In Canada, Write  
Canadian Electronic Institute, Toronto, Ontario

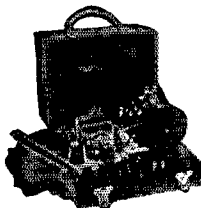

members of the framework, of 10 feet 6 inches will be adequate for any frequency in the 28-Mc. band.

The only difference between tuning the four-element 28-Mc. beam and the procedure outlined above for use on 14 Mc. comes from the fact that the elements are so short that it is desirable to adjust them from the two ends rather than by means of the short matching stubs. Therefore it is desirable to leave the elements off the framework until it is time actually to use them. The radiator is set up up first and tuned, as outlined. Then, and not until then, the reflector is set in place and tuned. Then the first director and lastly the second director. Similar minor adjustments may also be made to bring the beam into its most efficient state. The same procedure with relation to the elimination of standing waves may also be followed.

While the original W8JK type of beam remains our favorite for regular communication, there is no doubt about the greater gain, in a given direction, of the two-, three- and four-element uni-directional rotaries, when they are properly tuned. Of course, much of the ability to get real distance from any of these beams comes from setting them at the correct height above ground. That is a factor which is extremely difficult to figure for a group of circumstances, and on it will depend the ultimate performance of any beams of this type. However, without changing the height at all, both receiving and transmitting are improved very greatly. Well worth getting, to be sure!

## U.H.F. Relay

(Continued from page 53)

the years roll along, proving your earlier u.h.f. work, and for once we can guarantee every participant who reports one of 'em. We want to hear from every ham on 2½- and on 5-meters on these dates. Such a certificate is shown below:

After you get your test message off, your aim is to see how many you can work, what u.h.f. DX you can hear and raise, how many test messages you can push along, etc. For examples of message and information on handling data see page 33 of September QST.

U.h.f. conditions were fine last November, and we expect to see many states represented in the next report that did not get in on the September activity. Any u.h.f. bands can be used, 56, 112, or 224 Mc., etc., as you choose, and we'll report back to all who take part the full extent of the success in each frequency band group. Terminal stations, each starting an u.h.f. "msg", and each holding one or more that cannot be relayed on, at the end of the relay, are especially urged to see that we get reports of these promptly, so that full message histories may be made up . . . and once again we'll report to you on the routes of the most successful messages. Luck and b.c.n.u. in the Contest.

— F. E. H.



FOR THOSE WHO WANT THE BEST

At Last!

**A TRULY ALL-PURPOSE  
BEAM TRODE WITH  
INSTANT-HEATING FILAMENT**



40-watt beam-power amplifier having thoriated-tungsten filament—Phone ratings 50% greater than cathode type—Reduces battery drain in portable-mobile xmitters—Mechanically rugged, electrically ideal.

**Characteristics**

Filament (AC or DC) . . . . . 6.3 volts @ 1.5 amperes  
 Plate input . . . . . 600 max. v. & 100 max. ma.  
 Screen input . . . . . 300 max. v. & 15 max. ma.  
 Plate dissipation . . . . . 40 max. watts  
 Amplification factor . . . . . 135  
 R.F. grid driving power . . . . . less than 1 watt  
 R.F. output at max. input . . . . . 42 approx. watts

The HY69 is fully shielded for use in all radio frequency circuits—no neutralizing needed. Full ratings up to 60 megacycles.

**Uses**

Mobile transmitters . . . Class A or AB-2 modulators . . . Buffer amplifiers . . . Frequency multipliers . . . Final amplifiers . . . Power oscillators.

Use the HY69's in your main rig—transfer them to your portable unit when you take a trip—swap them to your emergency rig if necessary.

Just one tube type for every conceivable application—cuts your tube cost to the bone—yet you get maximum efficiency in all circuits.

5-prong ceramic base  
**HY69 \$3.50**  
 net

**HYTRONIC LABORATORIES**

A division of the Hytron Corp., 23 N. Derby St., Salem, Mass.

**SICKLES COILS**

SECURE A COPY OF OUR NO. 939 CATALOG FROM YOUR JOBBER

F. W. SICKLES COMPANY

300 Main Street

Springfield, Mass.

**P**iezo-Electric Crystals Exclusively

- Quality crystals of all practical frequencies supplied SINCE 1925. Prices quoted upon receipt of your specifications.

Our Pledge: **QUALITY FIRST**

**SCIENTIFIC RADIO SERVICE**

"The Crystal Specialists Since 1925" University Park, Hyattsville, Md.

• **TELEGRAPHY—TELEVISION—TELEPHONY** •

AVIATION  
 TRANSRADIO  
 PRESS  
 TELETYPE  
 TYPEWRITING



PRACTICAL  
 EXPERIENCE  
 STUDIO —  
 TRANSMITTER —  
 ANNOUNCING

The major technical training equipment owned by Port Arthur College and in operation on the college campus consists of the 500-Watt Commercial Broadcast Transmitter of Station KPAC, two-way Television Transmitter and Receiver, Latest Type RCA Marine and Airways transmitter installation complete, SOS Automatic Alarm, Marine Direction Finder, Trans-radio Press Receiving Equipment, and Laboratory complete where students assemble composite transmitters, amplifiers, audio amplifiers, R. F. amplifiers, etc.

Port Arthur College pioneered the teaching of Radio with classes in 1909, and for thirty years has maintained an active Employment Bureau for the placement of its graduates.

*If interested in details about Radio Course, write for Bulletin R*

**PORT ARTHUR COLLEGE** ■ **PORT ARTHUR (World-Known Port), TEXAS**

# MORE **TERMINAL**

## *Bargains!*

### **THORDARSON Plate Transformers**

**Type 16P00** — Delivers 650 or 500 D.C. volts @ 200 ma. Completely shielded. Wt. 8¾ lbs. Your cost..... **\$2.69**

**Type 16P03** — Will furnish 1250/1000 volts D.C. at 300 mills. Cased as illustrated. Wt. 30¾ lbs. Your cost.... **\$7.95**

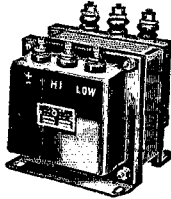

**Type 16P04** — Rated at 2500 or 2000 D.C. volts, @ 300 ma. Cased as illustrated. Wt. 42 lbs. Your cost..... **\$9.95**

### **STANCOR Power Transformers!**

Fully Shielded with Leads

Primary.....115 Volts, 50-60 cycles  
 Secondary No. 1.....1200 Volts C.T. @ 200 MA.  
 Secondary No. 2.....6.3 Volts @ 4 A.  
 Secondary No. 3.....6.3 Volts @ 2.5 A.  
 Secondary No. 4.....5.0 Volts @ 3 A.

Net Price, each, **\$2.95**

### **AVAILABLE AT BOTH STORES!**

**FREE!** New Stancor Hamannual! A complete guide for transmitter construction. Call at either store for your free copy.

All STANCOR transmitter kits in stock.

### **TRANSMITTING CONDENSERS**

Heavy filter units rated at 1 mfd. — 2000 volts and 2 mfd. — 1000 volts.

Your cost, each..... **85c**

\* Terminal never sacrifices quality to create "bargains." Every item is guaranteed, regardless of its low price.

### **IN STOCK AT BOTH STORES**

Millen Hetrofil..... **\$ 3.50**  
 Bliley VF1 Variable Crystal..... **6.60**  
 Skyrider Defiant (SX24)..... **69.50**  
 National NHU receiver..... **165.00**  
 Staco antenna relay..... **3.45**

# **TERMINAL** Radio Corp.

68 West 45th St. • 80 Cortlandt St.  
 2 stores in NEW YORK CITY  
 VAnDerbilt 6-5050 • Cable: TERMRADIO

## **Three-Element Beam Demonstration**

(Continued from page 69)

portance of keeping the antenna away from other objects.

Probably one of the most striking parts of the demonstration was that showing the importance of the correct length of the elements. With the beam pointed away from the field-strength pickup, the reflector element length was varied by a relatively small amount and wham! The meter needle flopped over almost to the pin, demon-

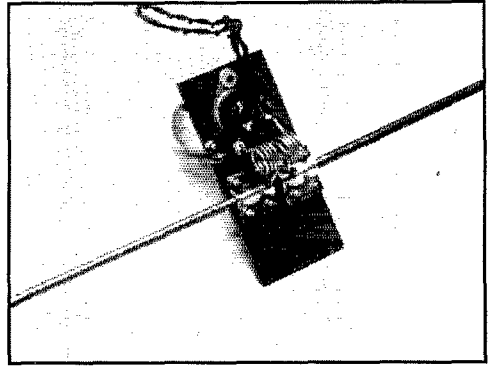

The simple field-strength meter used to demonstrate the beam.

strating quite vividly to everyone present the absolute necessity for careful tuning of the array for optimum results.

The transmitter used was of considerable interest to the u.h.f. men present. A 6V6 crystal oscillator, with a 5.5-Mc. crystal, doubled in the plate circuit to drive an 807 tripler which in turn drove a pair of HK24's in push pull. The push-pull amplifier was tuned to the third harmonic in the plate circuit, using a linear tank. With only 750 volts on the plates, 20 watts at 100 Mc. was obtained in the output.

— B. G.

## **SWITCH TO SAFETY!**

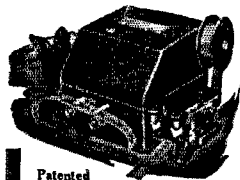

## **A Perfected AUTOMATIC SENDER**

Postpaid **\$12.50**  
 in U. S. A. **\$13.50** West of Denver

Patented

Let the Automatic Sender raise your stations for you. Repeats calls or messages indefinitely. Length of messages practically unlimited. Sends from 2 to 70 words a minute. Motor driven. Entirely automatic. Built-in tape perforator. Absolute uniformity in spacing of characters.

Excellent code teacher for beginners when connected with buzzer or oscillator. Free practice tape containing alphabet, numerals, and word combinations. Advanced students, speed up your receiving. Accustom yourself to any speed up to 70 W.P.M. Complete with 6 rolls of tape and full instructions. No extra equipment needed. If your dealer can't supply, write us.

FULLY GUARANTEED

**GARDINER-LEVERING CO.** Haddon Heights New Jersey, U. S. A.

# Where to buy it

A directory of suppliers who carry in stock the products of these dependable manufacturers.



**ALBANY, N. Y.** Uncle Dave's Radio Shack 356 Broadway  
**ATLANTA, GEORGIA** 265 Peachtree Street  
 Radio Wire Television Inc.  
**BOSTON, MASS.** Radio Shack 167 Washington Street  
**BOSTON, MASS.** 110 Federal Street  
 Radio Wire Television Inc.  
**BRONX, N. Y.** 542 East Fordham Rd.  
 Radio Wire Television Inc.  
**BUTLER, MISSOURI** 211-215 N. Main Street  
 Henry Radio Shop  
**CHICAGO, ILL.** 833 W. Jackson Blvd.  
 Allied Radio Corp.  
**CHICAGO, ILL.** 901-911 W. Jackson Blvd.  
 Radio Wire Television Inc.  
**CINCINNATI, OHIO** 1103 Vine Street  
 United Radio, Inc.  
**DETROIT, MICH.** 325 E. Jefferson Ave.  
 Radio Specialties Co.  
**DETROIT, MICHIGAN** 11800 Woodward Ave.  
 Radio Specialties Co.  
**HARTFORD, CONNECTICUT** 227 Asylum Street  
 Radio Inspection Service Company  
**HOUSTON, TEXAS** 4021 Huey Street  
 R. C. Hall & L. F. Hall  
**JAMAICA, L. I.** 90-08 166th Street  
 Radio Wire Television Inc.  
**KANSAS CITY, MO.** 1012 McGee Street  
 Burstein-Applebee Company  
**NEW YORK, N. Y.** Harrison Radio Co. 12 West Broadway  
**NEW YORK, N. Y.** 100 Sixth Ave.  
 Radio Wire Television Inc.  
**NEWARK, N. J.** 24 Central Ave.  
 Radio Wire Television Inc.  
**READING, PENN.** 404 Walnut St.  
 George D. Barbey Company  
**SPRINGFIELD, MASS.** T. F. Cushing 349 Worthington St.  
**WASHINGTON, D. C.** 938 F Street, N. W.  
 Sun Radio & Service Supply Co.

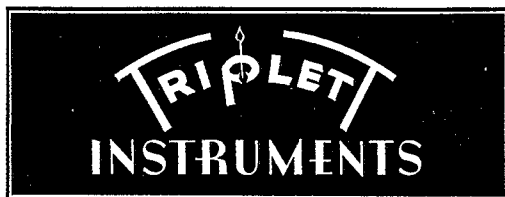

**ALBANY, N. Y.** Uncle Dave's Radio Shack 356 Broadway  
**ATLANTA, GEORGIA** 265 Peachtree Street  
 Radio Wire Television Inc.  
**BOSTON, MASS.** Radio Shack 167 Washington Street  
**BOSTON, MASS.** 110 Federal Street  
 Radio Wire Television Inc.  
**BRONX, N. Y.** 542 East Fordham Rd.  
 Radio Wire Television Inc.  
**BUTLER, MISSOURI** 211-215 N. Main Street  
 Henry Radio Shop  
**CHICAGO, ILLINOIS** 833 W. Jackson Blvd.  
 Allied Radio Corp.  
**CHICAGO, ILLINOIS** 25 North Franklin Street  
 Electric & Radio Supply Co., Inc.  
**CHICAGO, ILL.** 901-911 W. Jackson Blvd.  
 Radio Wire Television Inc.  
**CINCINNATI, OHIO** 1103 Vine Street  
 United Radio, Inc.  
**JAMAICA, L. I.** 90-08 166th Street  
 Radio Wire Television Inc.  
**LITTLE ROCK, ARKANSAS** 409 W. 3rd St.  
 Beem Radio Company  
**MINNEAPOLIS, MINNESOTA** 1124-26 Harmon Place  
 Lew Bonn Company  
**MUSKOGEE, OKLAHOMA** 204 No. Twelfth Street  
 Home Radio Mart  
**NEW YORK, N. Y.** 100 Sixth Avenue  
 Radio Wire Television Inc.  
**NEWARK, N. J.** 24 Central Ave.  
 Radio Wire Television Inc.  
**READING, PENN.** George D. Barbey Co. 404 Walnut Street  
**WASHINGTON, D. C.** 938 F Street, N. W.  
 Sun Radio & Service Supply Co.

Listings on this page do not necessarily imply endorsement by QST of the dealers or of other equipment sold by them.

# LEACH SOUND RECORDING EQUIPMENT.



**PRESENTING!**

## MODEL CA-12 KIT RECORDER

Here's the first and only recorder kit on the market, designed especially for the amateur and experimenter.

A complete 12", 78 r.p.m., recording-playback unit, small, compact, easy to assemble and simple to operate. Will produce results comparable to many higher-priced recorders.

Kit consists of all parts, with complete instructions for mechanical assembly, amplifier wiring and operating. Housing — unfinished hardwood, properly dressed for varnishing or enamelling, Fabrikoid or similar covering.



**KIT: \$80.00**

less microphone and tubes

Completely assembled Recorder

**\$125.00**

Ready for operation including microphone and tubes

See your nearest dealer or write us for Technical Bulletin.

**- ELECTRICAL INDUSTRIES MFG. CO., Inc. -**  
**RED BANK, NEW JERSEY, U.S.A.**

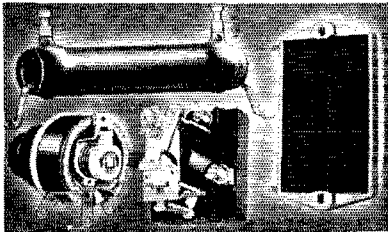

## Relays • Resistors • Rheostats

The oldest and most complete line on the market for service and amateur use. Proven dependability and conservative ratings. You are not experimenting when you install Ward Leonard items . . . you know they are right.

### || WARD LEONARD RADIO SPECIALTIES ||

**WARD LEONARD ELECTRIC COMPANY**  
41 South Street, Mount Vernon, N. Y.

Please send me Circular 507 covering Relays, Resistors and Rheostats.

Name.....  
Street.....  
City and State.....  
Call Signal.....

# AUDEL'S NEW RADIO MANS GUIDE THE KEY

FOR HOME STUDY



**TO WHAT EVERY RADIOMAN SHOULD KNOW**  
Information in a handy form covering modern Radio & Television in theory and practice. An entirely New Book that Points the Way to Success in Radio & Television — JUST OUT!  
**772 PAGES — 400 DIAGRAMS & PHOTOS.** Featuring Authentic, Clear & Concise Radio Information. Physics of Sound — Radio Fundamentals — Ohm's Law — Batteries — Measuring Instruments — Power Supplies — Resistors — Inductors — Condensers — Transformers — Broadcasting — Radio Telephony — Vacuum Tubes — Radio Diagrams — Receiver Construction — Control Systems — Loud Speakers — Antennas — Phonograph Pickups — Public Address Systems — Aircraft & Marine Radio — Radio Compass — Radio Beacons — Automatic Alarm — Short Wave Principles — Coll Calculations — Electronic Television — Testing — Interference Suppression — Trouble Pointers — Underwriter's Standards — Tables — Review Questions & Answers — Ready Reference Index.

**4** Get this practical information in handy form for yourself — Fill in and mail coupon today. **COMPLETE • PAY \$1 A MO.**

**HELP FOR YOU!**  
**THEO. AUDEL & CO., 49 WEST 23rd STREET, NEW YORK**  
Mail AUDEL'S NEW RADIOMANS GUIDE for free examination. IF O. K., I will send you \$1 in 7 days; then remit \$1 monthly until price of \$4 is paid. Otherwise, I will return it.  
Name.....  
Address.....  
Occupation.....  
Reference.....

Q.S.T.

# HAM-ADS

(1) Advertising shall pertain to radio and shall be of nature of interest to radio amateurs or experimenters in their pursuit of the art.

(2) No display of any character will be accepted, nor can any special typographical arrangement, such as all or part capital letters be used which would tend to make one advertisement stand out from the others.

(3) The Ham-Ad rate is 15¢ per word, except as noted in paragraph (6) below.

(4) Remittance in full must accompany copy. No cash or contract discount or agency commission will be allowed.

(5) Closing date for Ham-Ads is the 25th of the second month preceding publication date.

(6) A special rate of 7¢ per word will apply to advertising which, in our judgment, is obviously non-commercial in nature and is placed and signed by a member of the American Radio Relay League. Thus, advertising of bona fide surplus equipment owned, used and for sale by an individual or apparatus offered for exchange or advertising inquiring for special equipment, if by a member of the American Radio Relay League takes the 7¢ rate. An attempt to deal in apparatus in quantity for profit, even if by an individual, is commercial and all advertising by him takes the 15¢ rate. Provisions of paragraphs (1), (2), (4) and (5) apply to all advertising in this column regardless of which rate may apply.

Having made no investigation of the advertisers in the classified columns, the publishers of *QST* are unable to vouch for their integrity or for the grade or character of the products advertised.

**QUARTZ** — direct importers from Brazil of best quality pure quartz suitable for making piezo-electric crystals. Diamond Drill Carbon Co., 719 World Bldg., New York City.

**USED receivers.** Bargains. Cash only. No trades. Price list 3¢. W3DQ, Wilmington, Del.

**QSL'S.** Free samples. Printer, Corwith, Iowa.

**CALLBOOKS** — Fall edition now on sale containing complete up-to-date list of radio hams throughout entire world. Also world prefix map, press schedules and new time conversion chart. Single copies \$1.25. Canada and foreign \$1.35. Radio Amateur Call Book, 610 S. Dearborn, Chicago.

**CRYSTALS,** mounted, 80-160, \$1.25, V-cut 40, \$2.25. R9 Crystals, 338 Murray Ave., Arnold, Pa.

**QSL'S, SWL's.** 100 — 3 color — 75¢. Lapco, 344 W. 39th, Indianapolis, Ind.

**MACAULO** code machines; low monthly rental 50,000 words practice tapes. Write N. C. Ayers, 711 Boylston St., Boston, Mass.

**QSL'S.** Maps. Cartoons. Free samples. Theodore Porcher, 7708 Navajo, Philadelphia, Pa.

**COMPLETE** stock ham supplies. New and used communication receivers. Amarillo Electric, W5WX, Amarillo, Texas.

**QSL'S,** all colors, cartoons, snappy service. Write for free samples today. W1BEF, 78 Warrenton, Springfield, Mass.

**STANDS** for all types of microphones. Tri-ped, Jr. desk model, chrome or wrinkle, \$1.50. Ellis Lab., 189-Q W. Madison St., Chicago.

**MICROPHONES** — The best carbon microphones at anywhere near the price. Hand model \$5.75; stand model \$5; suspension model \$3.60; repairs. Ellis Lab., 189-T W. Madison St., Chicago.

**CRYSTALS** in plug-in heat dissipating holders. Guaranteed good oscillators. 160-80, \$1.25; (no Y cuts) 40X, \$1.65; 80M var-frequency, complete, \$2.95. State frequency desired. C.O.D.'s accepted. Pacific Crystals, 1042 So. Hicks, Los Angeles.

**QSL'S** — samples. Brownie, W3CJI, 523 No. Tenth St., Allentown, Pa.

**BEST** place to get amateur receivers is from W9ARA. Best trades, best terms (financed by myself), ten-day trial of all receivers. Prompt shipment from world's most complete stock of amateur receivers. Shipment from factory if you prefer. Write me fully about your wishes and I will help you get the best receiver for your use. Also distributor for all transmitters, antennas, kits parts. W9ARA, Butler, Mo.

**RECONDITIONED** guaranteed amateur receivers and transmitters. Ten days free trial. Nearly all models cheap. Terms. List free. Write W9ARA, Butler, Mo.

**CRYSTALS:** famous P.R., mounted in latest Alsimag 35 holders — 40, 80 meter PR-X, 160 meter PR-Z, \$3; 40, 80 meter PR-Z (low drift), \$3.50; 20-meter PR-20, \$4.50; unconditionally guaranteed. Immediate shipment. Wholesale Radio Labs., Council Bluffs, Iowa, W9GFQ.

**GENERAL** Radio — Roller-Smith 0-1.5 and 0-2.5 r.f. ameters, \$1.95. Signal Corps V.T. frequency meters, \$4.95. Signal Corps receivers, transmitters, parts. 5-10 auto converters wired, tested, \$15.94. Ditto 5-10 18-watt phone — CW transmitters, \$38.19. Write for bargain list. Radio Specialists, W9LLX, 215 No. Ada St., Chicago.

**CRYSTALS:** police, marine, aircraft, and amateur frequencies. Descriptive catalog. Ham Crystals, 1104 Lincoln Place, Brooklyn, N. Y.

**WHY** not get better deal? Used receiver list free. W9RA, Chirad, 415 So. Dearborn St., Chicago.

**SELL:** 1938 Super Skyriider, crystal, speaker. Best offer. W2HBH, 53-112 63 St., Maspeth, L. I.

**SELL:** RCA 3" oscillograph TMV-122-B, \$40; dynamotor 24 v.-1500 v. .233 amp. W2FKB, 9345 Vandever St., Queens Village, N. Y.

**QSL'S, SWL'S,** stationery, job printing. Free samples. W8DED, Holland, Mich.

**AMATEUR,** marine, broadcast. Transmitters, receivers, frequency meters, coils, condensers. Stock designs or built to any specifications by the oldest designers of short-wave apparatus. Also blueprint plans, specifications for any type transmitter or radio compass. Prices on request. Ensall Radio Lab., 1053 Kenilworth Ave., Warren, Ohio.

**SELL:** Utah transmitter, Premax antenna, \$31. Dalton Harrow, Frederick, Md.

**COMPLETE** line Arvin radios at special jobbing prices. Loughnane & Co., Decatur, Ill.

**QSL'S.** Samples. W6HBR Radio Press, P. O. Box 202, Clemenceau, Ariz.

**WANTED** 50 to 100 watt output transmitter factory built for 2118 and 2738 kc. 110 volt a.c. supply or marine transmitter. Dr. Young, WDGY, Minneapolis.

**GENERAL** Electric dynamotors 24/750 volts 150 watts, \$15. Westinghouse 6-15 volt 500 watt aircraft with propellers, \$8. 27 1/2/350 volt, \$8, 500 cycle 500 watt generators with exciters, \$8. Henry Kienzie, 215 Hart Blvd., Staten Island, N. Y.

**QSL'S,** newest designs. Fritz, 455 Mason, Joliet, Ill.

**TRADE:** complete 175 watt 20 meter phone transmitter for Filmo 8 camera and Filmo 8 projector. For details write or wire W4ENQ, Rome, Ga.

**WANTED:** commercial sideswiper or cootie key in good condition. Write W5GNEF.

**SELLING** out station — list — W2BZE.

**TELEPLEXES,** Instructographs, omnigraphs bought, sold, traded. Ryan's, Hannibal, Mo.

**QSL'S.** New free samples. Maleco, 1805 St. Johns Place, Brooklyn, N. Y.

**THEY** can take it. Storm proof steel frame quartz motorized hollow shaft rotators, tip-down head, built-in Selysynchron indicator, \$39. Adjustable telescoping tapered aluminum elements, Bassett products. Handbooks 25¢ with our bulletins, photos. Rotary Army Service, W8ML.

**QSO-crystals** — x-cut. AT-cut, 80 — 160 m., \$1.95; 40 x-cut. \$2.50. W8OUE, Paul Byers, Indiana, Pa.

**QSL, SWL** cards. Samples. 1608 1/2 No. High St., Columbus, Ohio.

**CRYSTALS:** commercial — amateur. Literature upon request. C-W Mfg. Co., 1170 Esperanza, Los Angeles.

**FOR** sale: complete 400 watt rack and panel phone transmitter, \$295. Charles Bartlett, 100 Park St., Portland, Me.

**RME-69** — excellent condition — \$82.50. W9IYA.

**QSL'S.** Samples. W9RUJ, Auburn, Neb.

**BARGAIN** 150 watt remote controlled push-to-talk modern rack and panel xmitter. W9WPFQ, Auburn, Ind.

**BEAUTIFUL** baked gray wrinkle and black crackle Masonite panels. Sizes to 27" x 48". Get prices. Panels, chassis, racks. Lynch, 970 Camulos, Los Angeles, Calif.

**T9** crystals: Announcing. Now exact frequencies in the 40 and 80 meter bands mounted and calibrated in T9 holder, \$3. Unmounted exact, \$2; within five kilocycles, \$1.60. T9 ceramic holders, \$1. T9 products are dependable, satisfaction guaranteed. C.O.D.'s accepted. Fast service. Sold by: Henry Radio Shop, Butler, Mo.; Frank Anzalone, 375 W. 46th, N. Y. C.; Radio Doc, 721 S. Main, Los Angeles, Calif.; Pemberton Labs., Fort Wayne, Ind.; Hieronymus Radio, 88-34 209th, Queens Village, N. Y.; Florida Distributors, Inc., Tampa, Fla.; O'Laughlin Radio Supply, Salt Lake City, Utah; Casa Edison, Havana, Cuba; and Edson's, Temple, Texas.

**QSL'S** — By W8NOS — 13 Swan St., Buffalo, N. Y.

**LOOK:** unbreakable feeder spreaders. High dielectric and tensile strength. \$1 per dozen six inch. W9DEO, Wisner, Neb.

**BUY** Douglas Universal modulation transformers. More audio watts per dollar. 50 watt pair, \$4.95; 100 watt pair, \$7.75. Postpaid in U. S. 1 year guarantee. Write W9IXR, Rice Lake, Wis.

**HAMMARLUND** Super Pro, world's finest receiver, xtal model, like new, cost me 261 bucks, best offer cash or terms takes it, correspondence answered. W6CD, Box 111, Albany, Calif.

**CREL products.** A new line of high quality economical transmitting units. Send for catalog describing exciters, R.F. amplifiers, power supplies, Class B amplifiers. Start with foundation unit and add later. Nothing to become obsolete. Lifetime quality. Cincinnati Radio Engineering Labs., Box 2, Sta. A, Cincinnati, Ohio.

**NEW receivers.** Used receivers. Rotary beams. Remember, I stock and make quick delivery on all lines of amateur equipment. Lowest prices. Write to Southern Ohio's only amateur owned amateur business. Jos. N. Davies, W8ANT, 2767 No. Bend Rd., Sta. A, Cincinnati, Ohio.

**TRADE:** 1500 v. power supply for genemotor, 300 v. 150 m. minimum. W9DDJ.

**SALE:** 250 watt phone transmitter. Whole or in parts. 50% off. W1ILB.

**GOVERNMENT contract surplus portable transmitters, direction finders, standard and special parts.** Send postcard for special bargain list. Airplane & Marine Direction Finder Corp., Clearfield, Pa.

**SELL complete transmitter, 400 watt phone, CW completely enclosed, two cabinets, remote control.** W2AEB.

**SELL:** HRO like new, reasonable. W8JAH.

**SALE or trade — High quality complete phone — CW transmitter 100-150 watts.** Also Thordarson dual power supply. Make offer. W3PTC.

**NEW Hammarlund APC100 condensers, 60¢.** Extraordinary bargains — power, audio transformers, chokes, gang condensers, dials, shield cans, parts. Radsur, Hyde, Pa.

**FOR sale — 5 ampere, 2 wire, 100 volt, 60 cycle, single phase, Westinghouse Type OA.** Wathour used house service meters. Meters in excellent condition. Price \$3 each. Municipal Commission, Herkimer, N. Y.

**SELL:** New RCA 852's, \$10 each. Filament, plate transformers, 1280 v. 280 ma., \$12. W8GWT, Penn Yan, N. Y.

**TRANSMITTERS, receivers, exciters, built to your specifications, or from popular publications.** Write today to W6QEU, Rt. 4, Box 350, Fresno, Calif.

**SACRIFICE:** 400 watts CW. Stamp for details. W8DX.

**EXTRAORDINARY opportunity — chance of a lifetime — W2IKV closing out.** World-famed Collins 202A, tubes, no crystals. \$1,000; Collins 30FXB complete, coils 160-80-20-10-5, \$300; RME-69 & silencer DB20 & speaker all RR mounting, \$135; RCA 3" oscilloscope, \$45; 2 kw. Variac, voltmeter in cabinet, \$50; 5 KVA 115-205/240 v. transformer, \$50; 2 250 TL never used, just received from Eimac, \$20 each; 2 Deluxe double channel racks & desks, \$37.50 each; Brush 12 cell broadcast microphone & floor stand, \$50; 2 76" steel towers, standing — buyer to remove, \$100 pair. Many spares. All inquiries accompanied by stamp answered. Mdse. perfect condition — offered subject to prior sale f.o.b. W2IKV, White Plains, N. Y.

**WANTED:** transmitter 200 — 400 watts phone & CW. Give description and price in first letter. Mr. Watts, 3619 Avenue H, Brooklyn, N. Y.

**SELLING ham station.** Transmitters, receiver, power supplies, meters, tubes, all equipment. E. Donovan, 43 Inman Pl., No. Arlington, N. J.

**WANTED:** National HRO and One-Ten. W1HOD, Holyoke, Mass.

**SELL for cash to highest bidder or trade:** Bassett, like new, 3 element complete Deluxe Rotomatic antenna including feed line — cost over \$135. W9BRN, Butler, Mo.

**SKY Challenger II crystal, non-matching speaker; perfect; \$50, cash. 100 w. transmitter, \$40, cash.** Write. W9RJP.

**MIMS — Bassett beams as low as \$10. down.** Your own terms on parts, kits, as we finance our own paper. New Stancor kits in and wired reasonably. Two-color QSL cards with \$3. purchases only 25¢ 100. Get sample — write Leo W9GFQ.

**FELLOWS — get the best bargains on reconditioned receivers and transmitters on your own terms.** Specials galore on General transformers — modulation transformers, 100 watt \$1.95 and others. Write for free big list to Leo W9GFQ, Wholesale Radio Labs., Council Bluffs, Iowa.

**IPS Rubber crystal, QSY remotely, varies completely 160 to 10 meters.** Approximately 20 watts output, \$19.80. All Electric Co., 1522 No. Clark, Chicago, W9IPS.

**FOR sale:** 180 watt transmitter complete with tubes, meter, 750 volt transformer, 4 mmf. 1000 v. condenser all for \$33. 250 watt transmitter, 5, 10, 20 meters — best of parts — \$37. W9ESM.

**SELLING out — high power, receiver.** Stamp for list. W5GUY, Rio Hondo, Texas.

**SELL:** AC-SW3, power supply, four sets bandspread coils. All like new. \$15. W8PJQ.

## LOW COST STEEL ANTENNA TOWER

*Used and Endorsed by*  
**FEDERAL, STATE, COUNTY, CITY GOV'TS.,  
FORESTRY, HIGHWAY PATROLS  
and HAMS everywhere!**

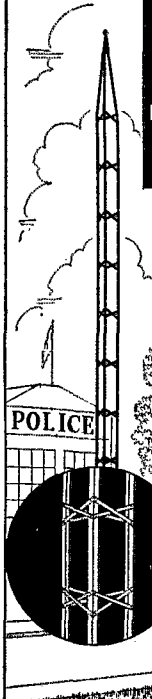

**ONLY 60¢ PER FOOT Complete!**

This remarkable low price is possible only because we produce many thousands of these towers each year for use with our Wincharger. Price includes necessary guy wires and tower sections of 10 or 20 ft. lengths with 5 ft. tapered stub top.

**LIGHT, STURDY, RIGID**

Thousands in use as vertical radiators and horizontal antenna supports. Scientifically braced. No points of undue strain. Both vertical angles and cross braces now hot dip galvanized. Quickly and easily erected to heights of from 25 ft. to 200 ft.

**READ U. S. FORESTRY LETTER!**

"Your tower was installed on Signal Peak, a Lookout Station on the Yakima Indian Reservation, at an elevation of 5,111 ft. above sea level. We have found the Wincharger tower 100% satisfactory and it has stood up under 70 mile winds, snow and ice which are severe at almost a mile up from sea level." Thomas L. Carter, Forest Supervisor, Office of Indian Affairs, U.S. Department of the Interior, Toppish, Wash.

**COMMERCIAL BROADCASTERS:**  
Write for complete information on new type heavy towers designed for heights up to 300 feet.

**WINCHARGER CORPORATION**  
Sioux City, Iowa

## EASY TO LEARN CODE

It is easy and pleasant work to learn the modern way — with an Instructograph Code Teacher. Ideal for the beginner or advanced student. Many tapes available ranging from alphabet for beginners to typical messages on all subjects. Speed range 5 to 40 WPM. Always ready, no QRM, beats having someone send to you.

**FOR SALE OR RENT**

**STANDARD** with 10 tapes and book of instructions.....\$20.25

**JUNIOR** with 5 tapes and book of instructions (not rented).....\$12.00

**RENTAL** Standard with 10 tapes and book of instructions \$3.00 first month, \$2.25 each additional month. All rental payments may be applied on the purchase price should you decide to buy the equipment.

*Write for details today*



### INSTRUCTOGRAPH COMPANY

Dept. Q, 912 Lakeside Place, Chicago, Illinois  
*Representatives for Canada:*  
Radio College of Canada, 54 Bloor St., West, Toronto

*The Perfect  
Christmas Gift  
for the "Ham"!*

**GORDON  
DX CLOCK**

Here's the clock that every amateur wants to own! World time at a glance! Instantly tells GMT or local time in any of the 24 Time Zones. Waltham electric movement with 24-hour colored dial. Only \$9.00. See it at your nearest dealer's or write for complete information.

**GORDON SPECIALTIES CO.**  
1104 So. Wabash Ave. Chicago, U. S. A.



# Your Nearby Dealer Is Your Best Friend

Your nearby dealer is entitled to your patronage. He is equipped with a knowledge and understanding of amateur radio. He is your logical source of advice and counsel on what equipment you should buy. His stock is complete. He can supply your needs without delay. His prices are fair and consistent with the high quality of the goods he carries. He is responsible to you and interested in you.

One of these dealers is probably in your city — Patronize him!

## ATLANTA, GEORGIA

Radio Wire Television Inc.  
265 Peachtree Street  
"The World's Largest Radio Supply House"

## NEWARK, N. J.

Radio Wire Television Inc.  
24 Central Avenue  
"The World's Largest Radio Supply House"

## BALTIMORE, MARYLAND

Radio Electric Service Co.  
3 N. Howard St.  
Everything for the amateur

## NEW HAVEN, CONNECTICUT

Hatry & Young, Inc.  
1172 Chapel Street  
National, Taylor, Kenyon T Line, Radiotron, Howard, etc.

## BOSTON, MASS.

Radio Wire Television Inc.  
110 Federal Street  
"The World's Largest Radio Supply House"

## NEW YORK, N. Y.

Radio Wire Television Inc.  
100 Sixth Avenue  
"The World's Largest Radio Supply House"

## BRONX, NEW YORK

Radio Wire Television Inc.  
542 East Fordham Road  
"The World's Largest Radio Supply House"

## NEW YORK, N. Y.

Harrison Radio Company  
12 West Broadway  
Harrison Has It! Phone WOrth 2-6276 for information or rush service

## BUFFALO, NEW YORK

Radio Equipment Corp.  
326 Elm Street  
W8PMC and W8NEL — Ham, service and sound equipment

## PHILADELPHIA, PENNSYLVANIA

Eugene G. Wile  
10 S. Tenth Street  
Complete Stock of Quality Merchandise

## BUFFALO, NEW YORK

Dymac Radio  
1531 Main Street — Cor. Ferry  
Open Evenings GA. 0252

## PROVIDENCE, RHODE ISLAND

W. H. Edwards Company  
85 Broadway  
National, Hammarlund, Hallicrafter, Thordarson, Taylor, RCA

## HOUSTON, TEXAS

R. C. & L. F. Hall  
4021 Huey Street (W 9-2713)  
"Specialists in Amateur Supplies"

## JAMAICA, L. I., NEW YORK

Radio Wire Television Inc.  
90-08 166th Street (Merrick Road)  
"The World's Largest Radio Supply House"

## RICHMOND, VIRGINIA

The Arnold Company  
Broad at Harrison St.  
W3EQQ — "The Virginia Ham Headquarters" — W3FBL

YOU CAN BE SURE  
WHEN YOU BUY FROM

**QST**

ADVERTISERS

“Advertising for *QST* is accepted only from firms who, in the publisher’s opinion, are of established integrity and whose products secure the approval of the technical staff of the American Radio Relay League.”

*Quoted from QST’s advertising rate card.*

*Every conceivable need of a radio amateur can be supplied by the advertisers in QST. And you will know the product has the approval of the League’s technical staff*

*Index to Advertisers*

Abbott Instrument, Inc.	96
Aerovox Corp.	98
American Radio Institute	110
Asatic Microphone Laboratory, Inc.	117
Audel & Company, Theo.	122
Barker & Williamson	96
Bliley Electric Company	113
Browning Laboratories, Inc.	98
Burgess Battery Company	103
Candler System Company	114
Capitol Radio Engineering Institute	102
Cardwell Mfg. Corp., Allen D.	91
Centralab	76
Collins Radio Company	Cov. 2
Cornell-Dubilier Electric Corp.	95
Dodge’s Institute	110
Eicor, Inc.	117
Eitel-McCullough, Inc.	85
Electrical Industries Mfg. Company, Inc.	122
Gardiner Levering Company	120
Gordon Specialties Company	124
Gross Radio, Inc.	118
Guthman & Company, Edwin L.	97
Hallcrafters, Inc., The	1, 2
Hammarlund Mfg. Company, Inc.	73, 75, 77
Harvey Radio Company	116
Henry Radio Shop	111
Hipower Crystal Company	102
Hygrade Sylvania Corp.	82
Hytronic Laboratories	119
Instructograph Company	124
International Resistance Company	7
Johnson Company, E. F.	88
Kato Engineering Company	118
Ken-Rad Tube & Lamp Corp.	117
Kenyon Transformer Company, Inc.	80
Mallory & Company, Inc., P. R.	72
Massachusetts Radio School	117
Millen Mfg. Company, Inc., James	87
Monitor Piezo Products	92
National Company, Inc.	Cov. 3, 71, 83, 115
New York YMCA Schools	108
Newark Electric Company	99
Nilson Radio School	106
Ohmite Mfg. Company	82
Port Arthur College	119
Precision Apparatus Corp.	90
Precision Piezo Service	108
Premax Products	113
RCA Institutes, Inc.	117
RCA Mfg. Company, Inc.	Cov. 4, 81
Radio City Products	115
Radio Mfg. Engineers, Inc.	127
Radio Shack, The	109
Radio Transceiver Laboratories	110
Scientific Radio Service	119
Shuler Supply Company	112
Sickles Company, F. W.	119
Signal Electric Mfg. Company	114
Simpson Electric Company	94
Solar Mfg. Corp.	108
Southwest Radio Supply	120
Speer Carbon Company	107
Standard Transformer Corp.	93
Sun Radio Company	112
Taylor Tubes, Inc.	4, 5
Teleplex Company	118
Terminal Radio Corp.	120
Thordarson Electric Mfg. Company	89
Triplett Elec. Instrument Company, Inc.	84
Turner Company	110
United Transformer Corp.	128
Valpey Crystals, The	106
Vibroplex Company, Inc., The	114
Ward Leonard Electric Company	122
Wholesale Radio Laboratories	109
Wincharger Corp.	124
Yaxley	72



# YESTERDAY

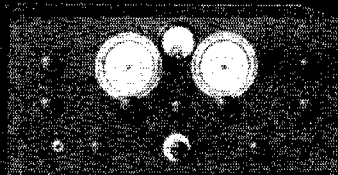

Who could have believed that RME receivers built five years ago would still be quite up-to-date today?

Our old RME-9D SIX YEARS AGO incorporated as standard:—bandswitching, crystal filter, panel control of beat oscillator, automatic volume control, tuned RF stage ahead of the first detector, direct reading R-meter, and resonating control; and all this in a day when those features were scarcely out of the laboratory.

Today we are building not one, but two, fine communication receivers — both of which, from all indications, are living up to the standards set by their predecessor of six years ago.

These models, known as the RME-69 and 70 have been designed and constructed with the same thoroughness which has given the older equipment such lasting qualities.

New parts, new tubes, and new circuits have been incorporated in RME receivers as rapidly as they have been developed, so that today, with their noise suppressors, high gain circuits, and stable characteristics they are extremely modern.

If the present RME receivers live up to the standard of longevity set by the 9D (and we think they will) they should still be in active service five years and even longer from now. Invest in a receiver which will give you years of continued satisfactory operation.

The new 12-page catalog is mailed to you on request.

# TODAY!

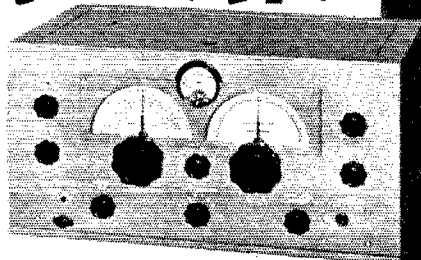

# TOMORROW

## RADIO MFG. ENGINEERS

INCORPORATED

111 HARRISON STREET

PEORIA

ILLINOIS

# UTC SPECIAL SERIES of TRANSFORMERS for AMATEUR APPLICATION

MAXIMUM VALUE AT LOW COST

FILTER, SWINGING, AND AUDIO CHOKES					
Type No.	Service	Inductance	Current	Resistance	Net Price
S-23	Audio P.P.	500 Hy.	5 Ma.	6000 ohms	\$1.35
S-24	Choke C.T.	500 Hy.	3 Ma.	4000 ohms	1.50
S-25	Filter	30 Hy.	30 Ma.	900 ohms	1.20
S-26	Filter	15 Hy.	60 Ma.	230 ohms	1.20
S-27	Filter	30 Hy.	75 Ma.	350 ohms	1.65
S-28	Filter	20 Hy.	100 Ma.	350 ohms	1.65
S-29	Filter	10 Hy.	175 Ma.	95 ohms	1.65
S-30	Swinging	5/25 Hy.	175 Ma.	95 ohms	1.65
S-31	Filter	20 Hy.	225 Ma.	120 ohms	2.10
S-32	Swinging	5/25 Hy.	225 Ma.	120 ohms	2.10
S-33	Filter	20 Hy.	300 Ma.	90 ohms	3.00
S-34	Swinging	5/25 Hy.	300 Ma.	90 ohms	3.00
S-35	Filter	20 Hy.	400 Ma.	85 ohms	3.90
S-36	Swinging	5/25 Hy.	400 Ma.	85 ohms	3.90
S-37	Filter	20 Hy.	550 Ma.	60 ohms	5.40
S-38	Swinging	5/25 Hy.	550 Ma.	60 ohms	5.40

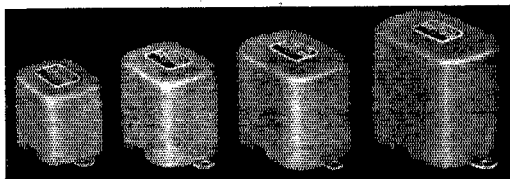

## UNIVERSAL DRIVER TRANSFORMERS

(See Modulator chart for tube types)

Type No.	Application	Net Price
S-8	Single driver plate to pushpull grids	\$1.65
S-9	Pushpull driver plates to grids of class B tubes up to 400 watts output.	2.25
S-10	Pushpull 56, 6C6 triode, 6C5, or similar plates to 45's, 2A3's or 6L6's, self or fixed bias.	2.10

SINGLE SECONDARY FILAMENT TRANSFORMERS				
Primary Tapped 105, 115 Volts — 50/60 Cycles				
Type No.	Secondary Volts	Secondary Current	Insulation	Net Price
S-53	2.5 VCT	10 A.	1500 V.	\$1.35
S-54	5 VCT	4 A.	2500 V.	1.35
S-55	6.3 VCT	3 A.	1500 V.	1.35
S-56	7.5 VCT	3 A.	1500 V.	1.35
S-57	2.5 VCT	10 A.	10,000 V.	1.80
S-58	2.5 VCT	20 A.	10,000 V.	2.40
S-59	5 to 5.25 VCT	13 A.	5000 V.	2.10
S-60	5 to 5.25 VCT	22 A.	10,000 V.	4.50
S-61	7.5 VCT tapped	8 A.		
	6.3 VCT		3000 V.	2.10
S-62	10 VCT	10 A.	3000 V.	2.40
S-63	14 VCT tapped	10 A.	5000 V.	4.50
	12 VCT and			
	11 VCT			

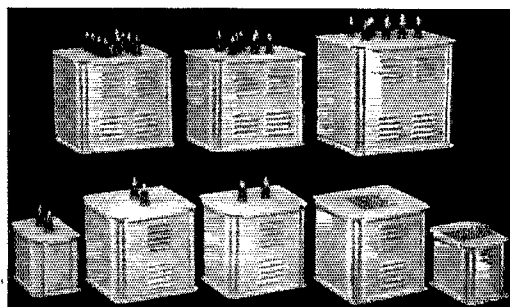

## UNIVERSAL OUTPUT TRANSFORMERS

Any modulator tubes to any RF load

MULTIPLE SECONDARY FILAMENT WINDINGS					
Primary Tapped 105, 115 Volts — 50/60 Cycles					
Type No.	Fil. 1	Fil. 2	Fil. 3	Insulation	Net Price
S-64	2.5 VCT-5A	2.5 VCT-5A	5 VCT-6A	3000 V.	\$2.40
S-65	2.5 VCT-5A	5 VCT-4A	6.3 VCT-3A	3000 V.	2.40
S-66	2.5 VCT-10A	7.5 VCT-6.5A		3000 V.	2.40
S-67	5 VCT-6A	6.3 VCT-5A		3000 V.	2.40
S-68	5 VCT-3A	6.3 VCT-4A	7.5 VCT-5A	3000 V.	2.70
S-69	6.3 VCT-3A	7.5 VCT-6.5A		3000 V.	2.70
S-70	6.3 VCT-5A	6.3 VCT-5A		3000 V.	2.70
S-71	2.5 VCT-6A	2.5 VCT-6A	2.5 VCT-12A	10000 V.	4.50
S-72	5 VCT-3A	5 VCT-3A	5 VCT-6A	5000 V.	3.00

Type No.	Audio Power	Net Price
S-18	12 watts	\$2.10
S-19	30 watts	2.85
S-20	55 watts	3.90
S-21	110 watts	6.00
S-22	250 watts	8.40

# UNITED TRANSFORMER CORP.

Write: COMMUNICATIONS DIV. ★ 150 VARICK ST. ★ NEW YORK, N. Y.  
EXPORT DIVISION: 100 VARICK STREET NEW YORK, N. Y. CABLES: "ARLAB"

QST for November, 1939, EASTERN Edition

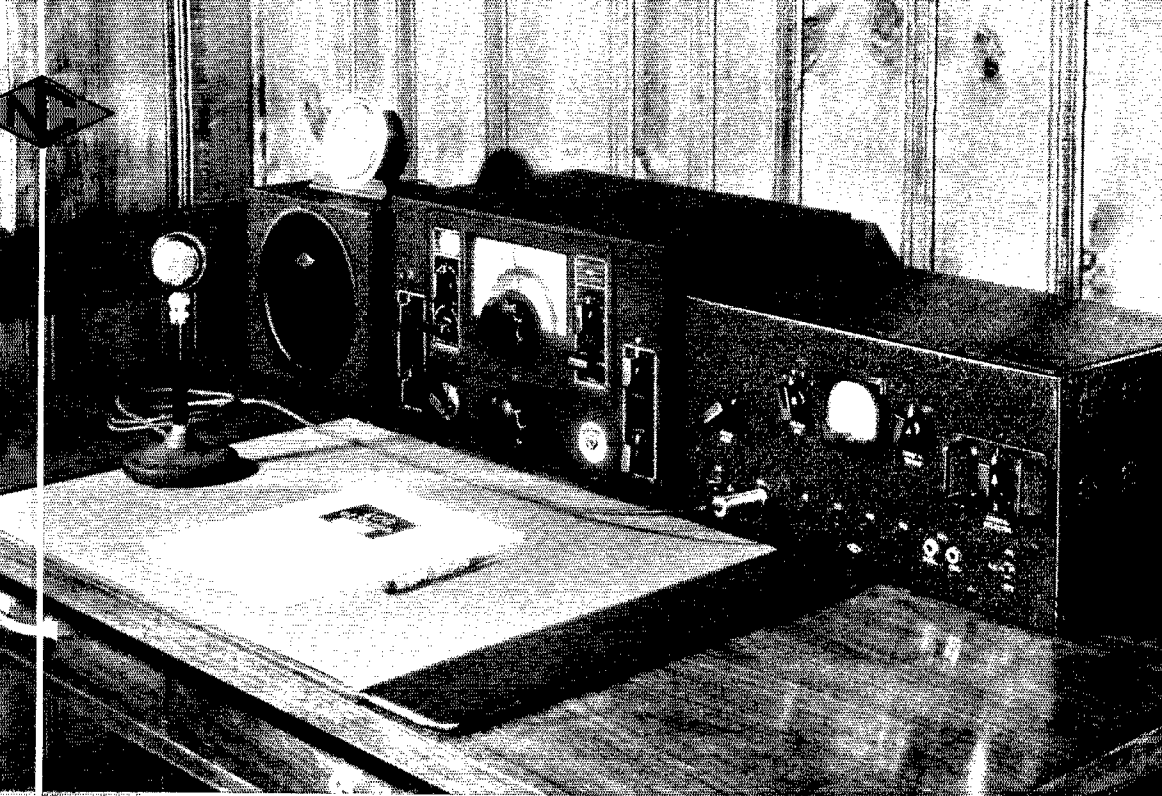

## READY TO GO

Equipped with the advanced noise limiter circuit described in October *QST*, the NC-101XA is ready to hang up new records. All the fine features, all of the outstanding performance of the older models have been retained, but to them have been added a noise limiter of truly remarkable effectiveness. The NC-101XA is master of adverse operating conditions. Combined with the NTE Exciter-Speech Amplifier, it forms the heart of a superb station.

**NATIONAL COMPANY, INC., MALDEN, MASS.**

# The GREATEST LOW-COST TUBE in RADIO HISTORY



**RCA-811 and RCA-812**  
 (High-mu type) (Low-mu type)  
**225 Watts Input.**  
**6.5 to 8 Watts Driving Power.**  
 ICAS Class "C" Telegraphy Ratings.

"Big league"  
 tube perform-  
 ance at only **\$3.50**  
 each  
 (Amateur Net)

Think of it! 225 watts power input to a \$3.50 tube!  
 Or, with a pair of the new RCA-811's or RCA-812's,  
 you can use an input of 450 watts. That's real power  
 plus real economy in any language.

This outstanding performance results largely from RCA's development of the Zirconium-coated anode, an exclusive RCA feature. These anodes mark an important forward step in the production of high-perveance, high-power tubes at hitherto unheard of low costs. They run cooler. They do a better job of

absorbing gases, even under high overloads. Other exclusive features of these tubes include the new low-loss RCA Micanol base, now available for the first time. Summed up, they answer the need for high power output with low driving power and moderate plate voltages—at a tube cost within the reach of all!

**Bulletin free upon request**

Class "C" Telegraphy Maximum Ratings	
*ICAS	*CCS
1,500 . . . D. C. Plate Voltage . . .	1,250
150 . . . D. C. Plate Current . . . . .	125
225 . . . Plate Input . . . . .	155
55 . . . Plate Dissipation . . . . .	40

**Featuring**  
 the New RCA  
**ZIRCONIUM-  
 COATED  
 ANODE**

- An outstanding RCA development.
- Runs cooler at full ratings.
- Gives instantaneous protection against gassing on overloads.



# Radio Tubes

RCA MANUFACTURING CO., INC.,  
 CAMDEN, N. J.  
 A Service of The Radio Corporation of America

FIRST IN METAL — FOREMOST IN GLASS — FINEST IN PERFORMANCE

**\* NEW RCA DUAL RATING  
 SYSTEM ANNOUNCED**

Ratings given here are the new RCA Intermittent Commercial Service (ICAS) and Continuous Commercial Service ratings described in detail on Page 81 of this issue.